

# SOUTH AFRICAN ROAD TRAFFIC SIGNS MANUAL

3rd Edition

## VOLUME 3 TRAFFIC SIGNAL DESIGN



**DIGITISED VERSION – May 2012**



# SOUTH AFRICAN ROAD TRAFFIC SIGNS MANUAL

3rd Edition

## VOLUME 3 TRAFFIC SIGNAL DESIGN

***DIGITISED VERSION  
May 2012***





**TITLE****SOUTH AFRICAN ROAD TRAFFIC SIGNS MANUAL  
VOLUME 3: TRAFFIC SIGNAL DESIGN****ISBN****STATUS**

DIGITISED

**DOT FILE**

000/0/0/0

**DATE**

April 2001

2<sup>nd</sup> Print (Aug 2004)

Digitised (May 2012)

**COMMISSIONED BY:**

National Department of Transport  
Private Bag X193  
PRETORIA  
0001  
SOUTH AFRICA

Committee of Transport Officials (COTO)  
Workgroup: Updating of SARTSM Volume 3: Traffic Signal Design

**DIGITISING CARRIED OUT BY**

TTT Africa  
p/a Jeffares & Green Inc  
PO Box 1109  
Sunninghill 2157  
Greater Johannesburg

**ORIGINAL AUTHORS**

Dr JD Sampson  
Dr SC van As  
Dr HS Joubert  
Mr G Dazeley  
Mr FJ Labuschagne  
Ms A Swanepoel

Jeffares & Green Inc  
Traffic Engineer  
Arcus Gibb  
Traffic Engineer  
Transportek, CSIR  
Alta Swanepoel & Associates

**COMMENTS**

Comments on, and other contributions, to this publication will be welcomed and appreciated. Such contributions and comments should be forwarded to the National Department of Transport at the above address. Contributions of significant extent will be acknowledged in future editions of the manual.

**COPYRIGHT**

This publication is protected by copyright under the Bern Convention. In terms of the Copyright Act No. 98 of 1978, no part of this publication may be reproduced or transmitted in any form or by any means, electronic or mechanical, including photocopying, recording or by any information storage or retrieval system, without permission in writing from the publisher.

© National Department of Transport, South Africa, 2001, 2004, 2012

**KEY WORDS**

Road sign, Traffic signal



**COMMITTEE OF TRANSPORT OFFICIALS (COTO)**  
**WORKGROUP: UPDATING OF SARTSM VOLUME 3: TRAFFIC SIGNAL DESIGN**

**Participating members of the workgroup**

|           |                |   |
|-----------|----------------|---|
| Chairman: | Mr RJV Slater  | National Department of Transport                          |
| Members   |                |   |
|           | Mr BH Botha    | Johannesburg Roads Agency                                 |
|           | Mr GW Botha    | Free State Public Works, Roads and Transport              |
|           | Mr IS Boyd     | City of Johannesburg                                      |
|           | Mr D Davey     | City of Cape Town   |
|           | Mr PW Douglass | Nelson Mandela Metropolitan Municipality                  |
|           | Mr T Fourie    | South African Bureau of Standards                         |
|           | Mr WJ Gorny    | KwaZulu-Natal Department of Transport                     |
|           | Ms LB Johnson  | National Department of Transport                          |
|           | Mr HAD Kirsten | uMhlathuze Municipality                                   |
|           | Mr MR Meijer   | Gautrans  |
|           | Mr CJ Mollett  | Provincial Administration Western Cape, Dept of Transport |
|           | Mr DH Thomas   | Durban Metro Council                                      |
|           | Mr HD Vorster  | City of Tswane Metropolitan Municipality                  |

**Acknowledgements**

The following persons are gratefully acknowledged for valuable contributions to and comments made on the manual:

|                  |              |
|------------------|--------------|
| Mr JL Coetzee    | Pretoria     |
| Mr D Davey       | Cape Town    |
| Ms SA Hinrichsen | Cape Town    |
| Ms J Oliver      | Cape Town    |
| Mr P Reynolds    | Pretoria     |
| Mr B van Biljon  | Johannesburg |
| Mr KM Wolhuter   | Pretoria     |









# SOUTH AFRICAN ROAD TRAFFIC SIGNS MANUAL

## VOLUME 3: TRAFFIC SIGNAL DESIGN

### LIST OF CONTENTS

|          |  |     |
|----------|--|-----|
| <b>0</b> | <b>CONTENTS</b>  | 0.1 |
| 0.1      | Part 1 - Traffic Signal Control – Chapters and Sections    | 0.1 |
| 0.2      | Part 2 - Traffic Signal Equipment – Chapters and Sections  | 0.4 |
| 0.3      | Part 3 – Traffic Signal Management – Chapters and Sections | 0.5 |
| 0.4      | Appendices   | 0.6 |
| 0.5      | List of Figures  | 0.7 |
| 0.6      | List of Tables   | 0.8 |
| 0.7      | Colour Details   | 0.9 |

### PART 1 – TRAFFIC SIGNAL CONTROL

|          |   |      |
|----------|---|------|
| <b>1</b> | <b>INTRODUCTION</b>                           |      |
| 1.1      | Background                                    | 1.1  |
| 1.2      | Traffic signal design and approval            | 1.1  |
| 1.3      | The traffic signal                            | 1.2  |
| 1.4      | Recommended and alternative systems           | 1.2  |
| 1.5      | Terminology                                   | 1.3  |
| 1.6      | Organisation of the manual                    | 1.3  |
| <b>2</b> | <b>TRAFFIC SIGNAL WARRANTS</b>                |      |
| 2.1      | Introduction                                  | 2.1  |
| 2.2      | Minimum requirements                          | 2.1  |
| 2.3      | Alternatives to traffic signals               | 2.1  |
| 2.4      | Traffic signal warrants                       | 2.2  |
| <b>3</b> | <b>TRAFFIC SIGNAL FACES</b>                   |      |
| 3.1      | Introduction                                  | 3.1  |
| 3.2      | Light signals and faces                       | 3.1  |
| 3.3      | Area of control                               | 3.1  |
| 3.4      | Control precedence                            | 3.1  |
| 3.5      | Vehicular light signals                       | 3.4  |
| 3.6      | Flashing and other modes of operations        | 3.7  |
| 3.7      | Arrangement of light signals on a signal face | 3.7  |
| 3.8      | Standard signal faces                         | 3.7  |
| 3.9      | Number and location of traffic signal faces   | 3.11 |
| 3.10     | Signals on high-speed roads                   | 3.12 |
| 3.11     | Visibility requirements                       | 3.12 |
| 3.12     | Mounting of vehicular traffic signals         | 3.14 |
| 3.13     | Traffic signal layout plans                   | 3.16 |

|          |   |      |
|----------|---|------|
| <b>4</b> | <b>PEDESTRIAN AND PEDAL CYCLIST SIGNALS</b>       |      |
| 4.1      | Introduction                                      | 4.1  |
| 4.2      | Pedestrian and pedal cyclist signals              | 4.1  |
| 4.3      | Operation of pedestrian and pedal cyclist signals | 4.2  |
| 4.4      | Provision of pedestrian signals at junctions      | 4.2  |
| 4.5      | Pedestrian scramble phase                         | 4.3  |
| 4.6      | Layout of pedestrian and pedal cyclist signals    | 4.3  |
| 4.7      | Mounting of pedestrian and pedal cyclist signals  | 4.3  |
| <b>5</b> | <b>JUNCTION LAYOUT</b>                            |      |
| 5.1      | Introduction                                      | 5.1  |
| 5.2      | Geometric design of signalised junctions          | 5.1  |
| 5.3      | Auxiliary lanes                                   | 5.4  |
| 5.4      | Road signs  | 5.10 |
| 5.5      | Road markings                                     | 5.10 |
| 5.6      | Road lighting                                     | 5.14 |
| 5.7      | Bibliography                                      | 5.14 |
| <b>6</b> | <b>SIGNAL TIMING AND PHASING</b>                  |      |
| 6.1      | Introduction                                      | 6.1  |
| 6.2      | Timing parameters                                 | 6.1  |
| 6.3      | Definition of phases                              | 6.1  |
| 6.4      | Managing signal settings                          | 6.2  |
| 6.5      | Signal timing plans                               | 6.3  |
| 6.6      | Traffic counts                                    | 6.3  |
| 6.7      | Signal phases                                     | 6.4  |
| 6.8      | Main signal phases                                | 6.4  |
| 6.9      | Left-turn signal phases                           | 6.4  |
| 6.10     | Right-turn signal phases                          | 6.5  |
| 6.11     | Warrants for right-turn signal phases             | 6.7  |
| 6.12     | The intergreen period                             | 6.7  |
| 6.13     | Traffic signal timing                             | 6.10 |
| 6.14     | Fixed time signal co-ordination                   | 6.16 |
| 6.15     | Fine-tuning traffic signals                       | 6.21 |
| 6.16     | Signal timing configuration diagrams              | 6.21 |
| 6.17     | Bibliography                                      | 6.24 |
| <b>7</b> | <b>VEHICLE-ACTUATED CONTROL</b>                   |      |
| 7.1      | Introduction                                      | 7.1  |
| 7.2      | Application of vehicle-actuated control           | 7.1  |
| 7.3      | Strategies of vehicle-actuated control            | 7.1  |
| 7.4      | Fully- and semi-actuated control                  | 7.2  |
| 7.5      | Minimum and maximum green                         | 7.3  |
| 7.6      | Stage reversion                                   | 7.3  |
| 7.7      | Vehicle detection                                 | 7.3  |
| 7.8      | Detector configurations                           | 7.4  |
| 7.9      | Pedestrian detection                              | 7.6  |
| 7.10     | Bibliography                                      | 7.6  |

|           |  |      |
|-----------|--|------|
| <b>8</b>  | <b>VEHICLE-RESPONSIVE CONTROL</b>                    |      |
| 8.1       | Introduction   | 8.1  |
| 8.2       | Control principles                                   | 8.1  |
| 8.3       | Bibliography   | 8.2  |
| <b>9</b>  | <b>AREA TRAFFIC CONTROL</b>                          |      |
| 9.1       | Introduction   | 9.1  |
| 9.2       | Master signal control                                | 9.1  |
| 9.3       | Fixed time area traffic control                      | 9.2  |
| 9.4       | Adaptive area traffic control                        | 9.2  |
| 9.5       | Traffic responsive control                           | 9.2  |
| 9.6       | Benefits of adaptive and responsive systems          | 9.6  |
| 9.7       | Data acquisition benefits                            | 9.6  |
| 9.8       | Bibliography   | 9.6  |
| <b>10</b> | <b>VEHICLE PRIORITY</b>                              |      |
| 10.1      | Introduction   | 10.1 |
| 10.2      | Detection of vehicles                                | 10.1 |
| 10.3      | Priority strategies                                  | 10.1 |
| <b>11</b> | <b>INDIVIDUAL VEHICLE CONTROL SIGNALS</b>            |      |
| 11.1      | Introduction   | 11.1 |
| 11.2      | Toll booths and checkpoints                          | 11.1 |
| 11.3      | Ramp metering  | 11.1 |
| <b>12</b> | <b>SIGNALS AT ROADWORKS</b>                          |      |
| 12.1      | Introduction   | 12.1 |
| 12.2      | Vehicle-actuated control                             | 12.1 |
| 12.3      | Two-way traffic in a single lane at roadworks        | 12.1 |
| <b>13</b> | <b>LANE DIRECTION CONTROL SIGNALS</b>                |      |
| 13.1      | Introduction   | 13.1 |
| 13.2      | Installation   | 13.1 |
| 13.3      | Operation  | 13.2 |
| <b>14</b> | <b>RAILWAY CROSSING SIGNALS</b>                      |      |
| 14.1      | Introduction   | 14.1 |
| 14.2      | Installation   | 14.1 |
| 14.3      | Operation  | 14.2 |
| <b>15</b> | <b>HAND AND OTHER SIGNALS</b>                        |      |
| 15.1      | General  | 15.1 |
| 15.2      | Control hand signals for use by traffic officers SS1 | 15.1 |
| 15.3      | Flag signals SS2                                     | 15.2 |
| 15.4      | Flashing yellow warning signals SS3                  | 15.2 |
| 15.5      | Flare signals SS4                                    | 15.3 |

## PART 2 – TRAFFIC SIGNAL EQUIPMENT

|           |   |      |
|-----------|---|------|
| <b>16</b> | <b>LIGHT SIGNALS AND POSTS</b>                      |      |
| 16.1      | Introduction  | 16.1 |
| 16.2      | Signal aspects                                      | 16.1 |
| 16.3      | Signal louvres and visors                           | 16.2 |
| 16.4      | Signal heads and background screens                 | 16.2 |
| 16.5      | Posts for supporting light signals                  | 16.2 |
| <b>17</b> | <b>FACILITIES FOR DISABLED USERS</b>                |      |
| 17.1      | Introduction  | 17.1 |
| 17.2      | The problems of pedestrians with visual impairments | 17.1 |
| 17.3      | Facilities to assist visually impaired pedestrians  | 17.1 |
| <b>18</b> | <b>TRAFFIC SIGNAL CONTROLLERS</b>                   |      |
| 18.1      | Introduction  | 18.1 |
| 18.2      | Controller types                                    | 18.1 |
| 18.3      | Controller functions                                | 18.1 |
| 18.4      | Conflict monitoring                                 | 18.1 |
| 18.5      | Fault monitoring                                    | 18.2 |
| 18.6      | Signal synchronisation                              | 18.2 |
| 18.7      | Controller cabinets                                 | 18.3 |
| <b>19</b> | <b>CENTRAL CONTROL SYSTEMS</b>                      |      |
| 19.1      | Introduction  | 19.1 |
| 19.2      | Control centres and rooms                           | 19.1 |
| 19.3      | Central control computers                           | 19.1 |
| 19.4      | Outstation control                                  | 19.2 |
| 19.5      | Communications                                      | 19.2 |
| 19.6      | Signal timing plans                                 | 19.3 |
| 19.7      | Emergency signal plans                              | 19.3 |
| <b>20</b> | <b>DETECTORS</b>                                    |      |
| 20.1      | Introduction  | 20.1 |
| 20.2      | Pedestrian push buttons                             | 20.1 |
| 20.3      | Vehicle detectors                                   | 20.1 |
| 20.4      | Detector operation                                  | 20.1 |
| 20.5      | Inductive loop detectors                            | 20.2 |
| 20.6      | Bibliography  | 20.4 |
| <b>21</b> | <b>AUTOMATED LAW ENFORCEMENT</b>                    |      |
| 21.1      | Introduction  | 21.1 |
| 21.2      | Violations at traffic signals                       | 21.1 |
| 21.3      | Implementation                                      | 21.1 |
| <b>22</b> | <b>POWER SUPPLY</b>                                 |      |
| 22.1      | Introduction  | 22.1 |
| 22.2      | Electrical requirements                             | 22.1 |
| 22.3      | Power supply cables                                 | 22.1 |
| 22.4      | Trenching and ducting                               | 22.2 |

## PART 3 –TRAFFIC SIGNAL MANAGEMENT

|           |   |      |
|-----------|---|------|
| <b>23</b> | <b>RESPONSIBILITIES AND DUTIES</b>          |      |
| 23.1      | Introduction                                | 23.1 |
| 23.2      | Institutional responsibility                | 23.1 |
| 23.3      | Institutional co-operation                  | 23.1 |
| 23.4      | Signal management                           | 23.1 |
| <b>24</b> | <b>RISK MANAGEMENT</b>                      |      |
| 24.1      | Introduction                                | 24.1 |
| 24.2      | Standards and guidelines                    | 24.1 |
| 24.3      | Notices of defect                           | 24.2 |
| 24.4      | Construction and repair                     | 24.2 |
| 24.5      | Risk management strategy                    | 24.2 |
| 24.6      | Personal liability                          | 24.3 |
| <b>25</b> | <b>MANPOWER REQUIREMENTS</b>                |      |
| 25.1      | Introduction                                | 25.1 |
| 25.2      | Traffic engineering                         | 25.1 |
| 25.3      | Electrical and electronic engineering       | 25.2 |
| 25.4      | Staffing levels                             | 25.2 |
| 25.5      | Education and technology transfer           | 25.3 |
| <b>26</b> | <b>TRAFFIC SIGNAL INSTALLATION</b>          |      |
| 26.1      | Introduction                                | 26.1 |
| 26.2      | Candidate site identification               | 26.1 |
| 26.3      | Warrant study                               | 26.1 |
| 26.4      | Signal design                               | 26.1 |
| 26.5      | Signal installation                         | 26.2 |
| 26.6      | Commissioning                               | 26.3 |
| <b>27</b> | <b>REMOVAL OF TRAFFIC SIGNALS</b>           |      |
| 27.1      | Introduction                                | 27.1 |
| 27.2      | Identification of signals requiring removal | 27.1 |
| 27.3      | Removal procedure                           | 27.1 |
| <b>28</b> | <b>TRAFFIC SIGNAL MAINTENANCE</b>           |      |
| 28.1      | Introduction                                | 28.1 |
| 28.2      | Consequences of maintenance deficiencies    | 28.1 |
| 28.3      | Reducing maintenance requirements           | 28.1 |
| 28.4      | Types of maintenance                        | 28.1 |
| 28.5      | Routine maintenance                         | 28.1 |
| 28.6      | Repair maintenance                          | 28.3 |
| 28.7      | Maintenance records                         | 28.4 |
| 28.8      | Maintenance personnel                       | 28.4 |
| 28.9      | Maintenance resources                       | 28.4 |
| 28.10     | Contract maintenance                        | 28.5 |
| 28.11     | Bibliography                                | 28.5 |
| <b>29</b> | <b>SIGNAL TIMING UPGRADING</b>              |      |
| 29.1      | Introduction                                | 29.1 |
| 29.2      | Need for updating                           | 29.1 |
| 29.3      | Data requirements                           | 29.1 |
| 29.4      | Traffic counting systems                    | 29.2 |

**30 TRAFFIC SIGNAL RECORDS**

|      |                              |      |
|------|------------------------------|------|
| 30.1 | Introduction                 | 30.1 |
| 30.2 | Installation records         | 30.1 |
| 30.3 | Fault log and advice records | 30.1 |
| 30.4 | Maintenance records          | 30.1 |
| 30.5 | Controller logs              | 30.2 |
| 30.6 | Archiving of records         | 30.2 |
| 30.7 | Referencing systems          | 30.2 |

**31 CONTRACTS**

|      |                                 |      |
|------|---------------------------------|------|
| 31.1 | Introduction                    | 31.1 |
| 31.2 | Content of contract documents   | 31.1 |
| 31.3 | Structure of contract documents | 31.1 |
| 31.4 | Tender process                  | 31.2 |
| 31.5 | Procurement                     | 31.2 |
| 31.6 | Service level agreements        | 31.2 |
| 31.7 | Bibliography                    | 31.2 |

**32 ANNUAL REPORTS**

|      |                               |      |
|------|-------------------------------|------|
| 32.1 | Introduction                  | 32.1 |
| 32.2 | Contents of the annual report | 32.1 |

## APPENDICES

|          |                                       |
|----------|---------------------------------------|
| <b>A</b> | <b>GLOSSARY OF TERMS</b>              |
| <b>B</b> | <b>EXAMPLE TRAFFIC SIGNAL LAYOUTS</b> |
| <b>C</b> | <b>TRAFFIC SIGNAL CHECKLISTS</b>      |
| <b>D</b> | <b>TRAFFIC SIGNAL FORMS</b>           |



## LIST OF FIGURES

|      |   |      |
|------|---|------|
| 2.1  | Queue length observations   | 2.4  |
| 3.1  | Definition of intersections, junctions, slipways and pedestrian crossings   | 3.2  |
| 3.2  | Examples of road signs used in conjunction with traffic signals   | 3.3  |
| 3.3  | Standard traffic signal faces and traffic signal arrow signs  | 3.8  |
| 3.4a | Signalling for protected-only right turn at a T-junction  | 3.10 |
| 3.4b | Signalling for protected-only right turn at a 4-way junction (road divided by median)   | 3.10 |
| 3.5a | Traffic signal sequence for protected/permitted right-turn phases using a S8 signal face  | 3.13 |
| 3.5b | Traffic signal sequence for protected-only right-turn phases using the S1 and S1R signal faces in conjunction with the ST5 and St2 traffic signal arrow signs | 3.13 |
| 3.6  | Cone of vision in horizontal plane  | 3.15 |
| 3.7  | Standard post mounting  | 3.17 |
| 3.8  | Extended post mounting  | 3.17 |
| 3.9  | Overhead (cantilever) mounting of traffic signal faces  | 3.17 |
| 3.10 | Example traffic signal layout plan  | 3.18 |
| 3.11 | Alternative traffic signal layout plan using graphic symbols for signal faces   | 3.19 |
| 4.1  | Alternative positions for pedestrian and pedal cyclist signals at signalised junctions  | 4.4  |
| 4.2  | Pedestrian (and pedal cyclist) signal faces at a mid-block crossing   | 4.4  |
| 4.3  | Staggered mid-block pedestrian crossing   | 4.5  |
| 4.4  | Staggered pedestrian crossing on a wide junction  | 4.5  |
| 4.5  | Pedestrian crossing road markings at a junction   | 4.6  |
| 4.6  | Mounting pedestrian and pedal cyclist signals   | 4.6  |
| 5.1  | Vehicle swept paths through a signalised junction   | 5.3  |
| 5.2  | Auxiliary through lanes at signalised junctions   | 5.3  |
| 5.3  | Provision of right-turn lanes at a signalised junction  | 5.6  |
| 5.4  | Restricted sight distance for right-turning traffic due to a very wide median   | 5.7  |
| 5.5  | Restricted sight distance for right-turning traffic due to a horizontal curve (bottom-to-top direction)   | 5.7  |
| 5.6  | Free-flow and controlled slipways at a signalised junction  | 5.9  |
| 5.7  | Road junction with pedestrian crossing markings   | 5.13 |
| 5.8  | Guide lines through a junction  | 5.13 |
| 6.1  | Example of signal intervals for a three-stage traffic signal with six signal groups   | 6.2  |
| 6.2  | Various types of traffic signal phases at a signalised junction   | 6.5  |
| 6.3  | Measurement of clearance widths W   | 6.11 |
| 6.4  | Example signal timing of a signalised T-junction  | 6.15 |
| 6.5  | Example progression diagram   | 6.17 |
| 6.6  | IN and OUT flow patterns at a traffic signal  | 6.18 |
| 6.7a | Example platoon dispersion diagram  | 6.20 |
| 6.7b | Example platoon dispersion diagram with improved offsets  | 6.20 |
| 6.8a | Example signal timing diagram – Signal groups and staging   | 6.25 |
| 6.8b | Example signal timing diagram – Signal group and stage data   | 6.26 |
| 6.8c | Example signal timing diagram – Signal plans and timings  | 6.27 |
| 7.1  | Searching for gaps in the traffic stream  | 7.2  |
| 7.2  | Right-turn detector configuration   | 7.5  |
| 7.3  | Single stop line detector configuration   | 7.7  |
| 7.4  | Double detector configuration (design speed 40 km/h)  | 7.7  |
| 7.5  | Triple detector configuration (design speed 20/30 km/h)   | 7.7  |
| 8.1  | Typical layout of detectors   | 8.2  |

|      |   |      |
|------|---|------|
| 9.1  | Schematic for linking co-ordinated signals              | 9.1  |
| 9.2  | Adaptive traffic control vehicle detector layout        | 9.3  |
| 9.3  | Traffic responsive control vehicle detector layout      | 9.4  |
| 9.4  | Projected traffic demand profile at downstream junction | 9.5  |
| 9.5  | Flexibility of traffic responsive control               | 9.7  |
| 11.1 | Single vehicle release operating sequence               | 11.1 |
| 11.2 | Ramp metering application of the S12 signal face        | 11.2 |
| 13.1 | Standard lane direction control signals                 | 13.1 |
| 13.2 | Permitted variants of lane direction control signals    | 13.1 |
| 13.3 | Back-to-back mounting of lane direction control signals | 13.2 |
| 14.1 | Flashing red disc light signals at railway crossings    | 14.1 |
| 15.1 | Control hand signals for use by traffic officers SS1    | 15.4 |
| 15.2 | Flag signals SS2  | 15.4 |
| 15.3 | Flashing yellow warning signals SS3                     | 15.4 |
| 16.1 | Components of a signal aspect                           | 16.1 |
| 16.2 | Signal head with standard visors                        | 16.2 |
| 16.3 | Signal head with cut-away visors                        | 16.2 |
| 16.4 | Improving conspicuity of signals                        | 16.3 |
| 18.1 | Schematic presentation of controller functions          | 18.2 |
| 20.1 | Inductive loop shapes and sizes                         | 20.3 |
| 20.2 | Inductive loop wire slot cut into the road surface      | 20.4 |
| 22.1 | Drip loop on a power cable                              | 22.1 |
| 22.2 | Example of duct and draw box layout at a junction       | 22.2 |

## LIST OF TABLES

|      |   |      |
|------|---|------|
| 3.1  | Recommended sight distances for traffic signals                 | 3.15 |
| 5.1  | Summary of road markings for signalised junctions and crossings | 5.12 |
| 6.1  | Recommended yellow and clearance or all-red intervals (seconds) | 6.9  |
| 6.2  | Recommended additional all-red intervals at slipways (seconds)  | 6.9  |
| 25.1 | Desirable staffing levels                                       | 25.2 |
| 28.1 | Routine maintenance   | 28.2 |
| 29.1 | Signal timing updating cycle (years)                            | 29.1 |

# STANDARD TRAFFIC SIGNAL FACES AND TRAFFIC SIGNAL ARROW SIGNS

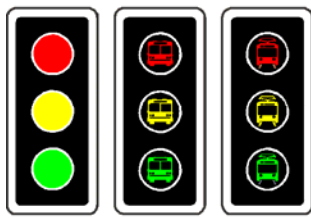

S1 S1B S1T

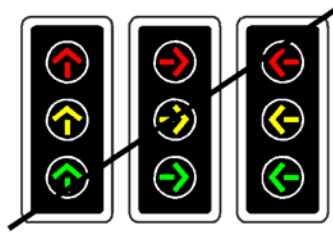

S1A S1AR S1AL

Note: S1A, S1AR and S1AL used only in the Alternative System

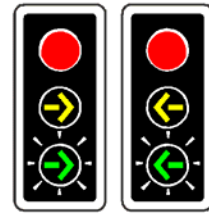

S1R S1L

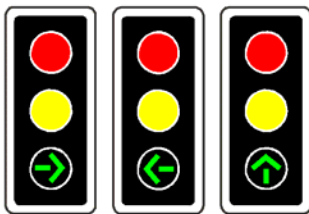

S2 S3 S4

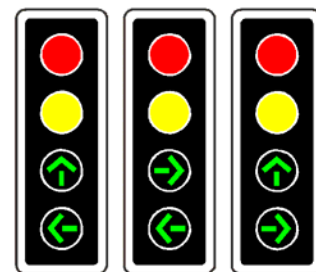

S5 S6 S7

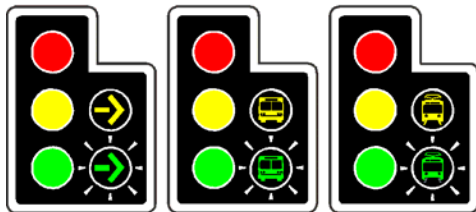

S8 S8B S8T

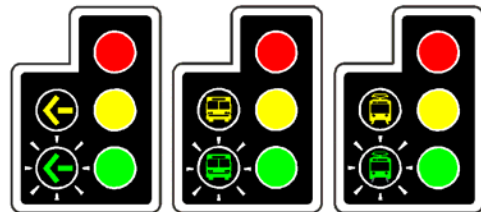

S9 S9B S9T

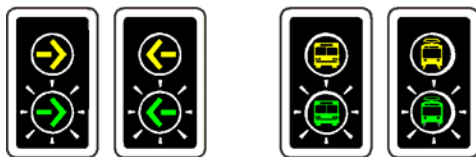

S10R (S10) S10L S10B S10T



S11P (S11) S11C (S20)



S12



S17 S16 S18 S19



ST5 ST4



ST3 ST1 ST2  
Traffic signal arrow signs

# OTHER ROAD SIGNALS

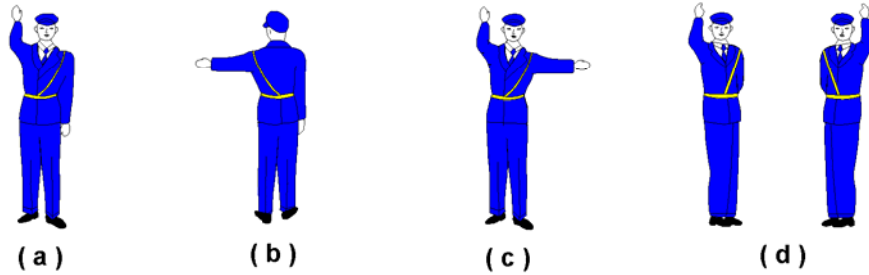

Control hand signals for use by traffic officers SS1

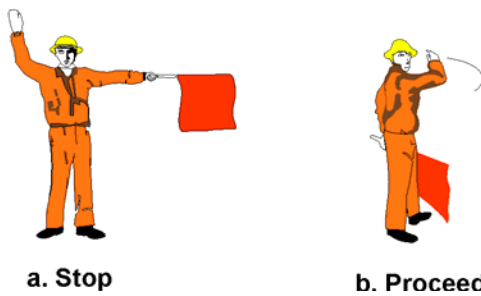

a. Stop  
b. Proceed  
Flag signals SS2



Warning flag signal

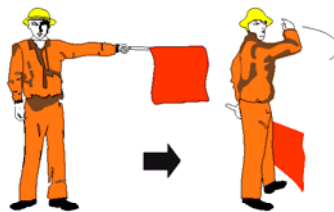

Using stop/proceed flag signals to slow traffic down

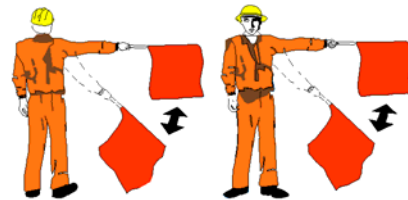

Warning traffic in two directions



Flashing yellow warning signal SS3



Flashing Red Disc (FRD) signal at railway crossings

# **SOUTH AFRICAN ROAD TRAFFIC SIGNS MANUAL**

## **VOLUME 3: TRAFFIC SIGNAL DESIGN**

**DIGITISED VERSION – May 2012**

### **PART 1 TRAFFIC SIGNAL CONTROL**

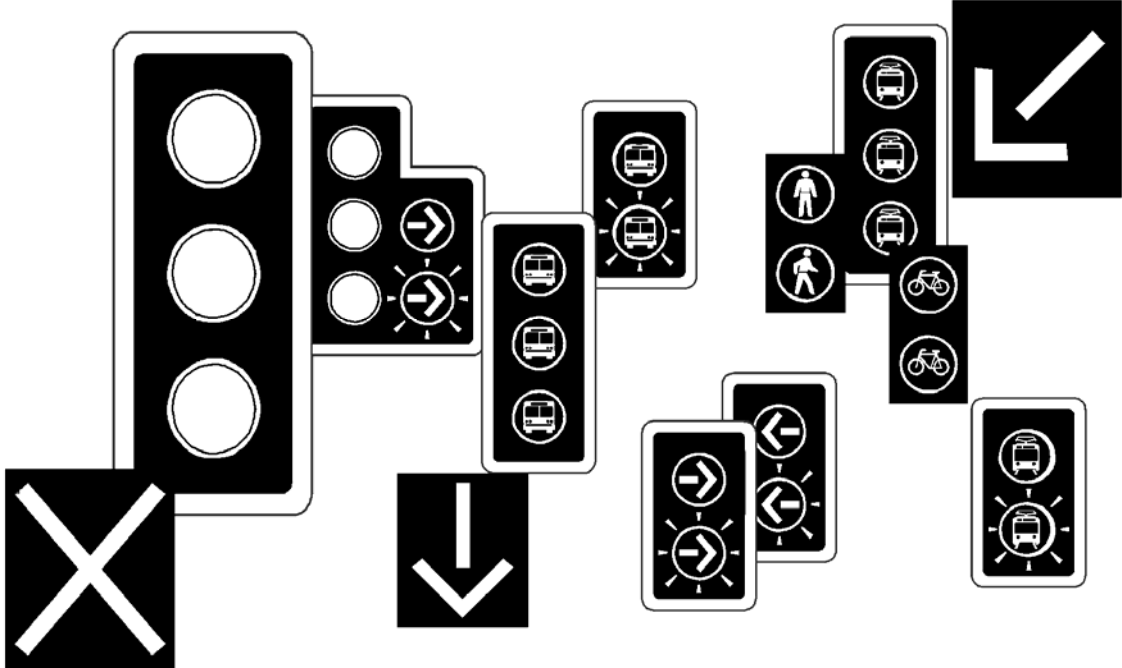



## CHAPTER 1: INTRODUCTION

### 1.1 BACKGROUND

- 1 The Road Traffic Signs Manual comprises the following four volumes:
  - (a) Volume 1: Uniform Traffic Control Devices – Details signing policies and design principles together with specific information on the meaning and individual application of all traffic control devices (including a chapter on traffic signals).
  - (b) Volume 2: Traffic Control Device Applications – Covers the use of sets of signs, markings and signals for specific applications.
  - (c) Volume 3: Traffic Signal Design (this manual) – Details requirements for the selection and installation of traffic signals and their methods of control.
  - (d) Volume 4: Traffic Signs Design – Provides dimensional detail for all road traffic signs and their sign face components.
- 2 This manual is Volume 3 of the Road Traffic Signs Manual. It contains the information and practical guidance required to provide efficient and effective traffic signalling. It covers the most common types of signal installations at road junctions and pedestrian crossings, and offers advice on how the more complex installations and systems might be approached.
- 3 The manual covers all the information applicable to the “Recommended Traffic Signal System” given in the following publications, and can be read without referring to these documents:
  - (a) National Road Traffic Act and Regulations.
  - (b) Chapter 6 of Volume 1 of the SADC Road Traffic Signs Manual.

**However, should there be differences between the different documents, the National Road Traffic Act and Regulations have legal precedence, followed by Chapter 6 of Volume 1 of the Manual (followed by this manual).**
- 4 The manual is a design manual and does not contain technical specifications of traffic signals, although some functional requirements are provided that may be considered when installing traffic signals. For information on technical specifications, publications such as the following should be consulted:
  - (a) Volume 4 of the SADC Road Traffic Signs Manual.
  - (b) South African Bureau of Standards specification SANS 1459: *Traffic lights*.
  - (c) South African Bureau of Standards specification SANS 1547: *Traffic signal controllers*.
  - (d) Other SABS specifications related to electrical work and installations.
  - (e) SABS specifications related to law enforcement devices (particularly those related to speeding and violation of the red light signal).

### 1.2 TRAFFIC SIGNAL DESIGN AND APPROVAL

- 1 The manual is mainly aimed at the traffic engineering profession involved with traffic signals. Some aspects related to the civil, electrical and electronic engineering fields are covered in the manual, with mainly the intention of providing the traffic engineer with an overview of the multi-disciplinary nature of traffic signals as well as the tasks required to provide a complete traffic signal installation.
- 2 This manual presupposes a basic knowledge of transportation and traffic engineering, and is not intended to be a training manual. It can, however, be used for educational purposes, but additional information and amplification would be required.
- 3 Due to the complexity of traffic signal systems, decisions concerning the design, installation, and operation of traffic signals, should only be undertaken by professionals with a high level of skill and knowledge of the subject. Such professionals should, as a minimum, have a thorough knowledge and understanding of the contents of this manual.
- 4 The National Road Traffic Regulations require that a **“A responsible registered PROFESSIONAL ENGINEER or registered professional TECHNOLOGIST (engineering) of the road authority concerned SHALL approve every traffic signal installation at a signalised junction or pedestrian or pedal cyclist crossing, and sign a declaration containing the following:**
  - (a) **scaled drawing of the layout of the junction or crossing, indicating lane markings and road layout;**
  - (b) **number, type and location of traffic signal faces;**
  - (c) **number, type and location of pedestrian and pedal cyclist facilities, including pedestrian push buttons;**
  - (d) **phasing, time plans and offset settings;**
  - (e) **date of implementation; and**
  - (f) **name, signature and registration number of the engineer or technologist (engineering) who approved the signal, and date of signature.”**
- 5 In addition to the above, the regulations also require that the **“declaration shall be kept by the road authority in control of the traffic signal concerned”**.
- 6 Checklists are provided in Appendix C of this manual that may be used for the approval of traffic signals. The checklists cover most of the minimum requirements for traffic signals as set out in this manual. The following three checklists are provided:
  - (a) Traffic signal layout
  - (b) Traffic signal phasing and timing.
  - (c) Traffic signal commissioning.

### 1.3 THE TRAFFIC SIGNAL

- 1 Although this manual is titled "Traffic Signal Design", it in fact covers all signals defined in the National Road Traffic Regulations as "**road signals**". The regulations classify road signals as follows:
  - (a) Regulatory signals.
    - (i) *Traffic signals* used for the regulation of vehicular road traffic, pedestrians and pedal cyclists.
    - (ii) *Red flashing signals* used at railway crossings.
    - (iii) *Overhead lane direction control signals*.
    - (iv) *Other regulatory signals*, including control hand signals used by traffic officers and flag signals.
  - (b) Warning signals.
    - (i) *Warning flashing signals*.
    - (ii) *Warning flag signals*.
- 2 These signals are shown in the colour plates in the front of this manual. The plates illustrate all traffic signals in colour as if they are illuminated, which obviously does not occur under operational conditions.
- 3 The above signals can be used for the control of traffic at location such as:
  - (a) signalised road junctions;
  - (b) signalised pedestrian and pedal cyclist mid-block crossings;
  - (c) the intersection of roads with exclusive public transport rights of way;
  - (d) single traffic lanes that carry two-way traffic;
  - (e) freeway ramps and toll booths;
  - (f) roadworks;
  - (g) reversible lanes; and
  - (h) railway crossings.
- 4 The main objective in operating traffic signals is to improve road safety and to reduce excessive vehicular, pedestrian and pedal cyclist delay. Traffic signals may be used for any one or more of the following purposes :
  - (a) to reduce conflict between vehicles and other traffic, including pedestrians and pedal cyclists;
  - (b) to enable pedestrians and pedal cyclists to cross the road safely;
  - (c) to improve the traffic-handling capability or capacity of the road network;
  - (d) to provide for the safe and orderly movement of traffic;
  - (e) to reduce delay and stops to side-road or crossing traffic;
  - (f) to provide for continuity in the movement of vehicles along particular routes;
  - (g) to give preference to the progression of particular classes of vehicles or a particular directional movement of traffic;
  - (h) to control the movement of vehicles at specific locations or into selected parts of the road network;
  - (i) to indicate alterations in the direction of use of lanes (reversible lanes);
  - (j) to warn of unexpected potential hazards.
- 5 Traffic signals that are not properly installed, or that are not warranted, should not be in operation. Traffic signals that are not warranted, incorrectly designed, badly placed, wrongly timed or poorly maintained may result in problems such as:
  - (a) unnecessary delay;
  - (b) disobedience of traffic signals;
  - (c) increased collisions, particularly of the rear-end type; and
  - (d) diversion to less-adequate alternative routes or "rat-runs".

### 1.4 RECOMMENDED AND ALTERNATIVE SYSTEMS

- 1 Two basic types of traffic signal systems are used in the Southern African Development Community (SADC) region, namely the Recommended and Alternative systems. The Recommended system is used in South Africa and in most of the SADC states. Some states, however, use the Alternative system and it would be financially or operationally impractical for these states to harmonise with the rest of the region in the short term.
- 2 The most significant differences between the two systems are as follows:
  - (a) In the Recommended System the traffic signal switching cycle is GREEN - YELLOW - RED, whereas in the Alternative System the switching cycle is RED plus YELLOW - GREEN - YELLOW - RED.
  - (b) The Recommended System utilises a FLASHING GREEN ARROW LIGHT SIGNAL instead of a STEADY GREEN ARROW SIGNAL when giving right of way to turning movements.
  - (c) The Recommended System uses FLASHING RED LIGHT SIGNALS on all approaches to indicate an out of order traffic signal. The Alternative System utilises FLASHING YELLOW LIGHT SIGNALS for this purpose.
  - (d) In the Recommended System the pedestrian/cyclist "do not start to cross" message is given by a FLASHING RED LIGHT SIGNAL, whereas in the Alternative System this same message is given by a FLASHING GREEN LIGHT SIGNAL.
  - (e) In the Recommended System the required principal traffic signal faces are required to be mounted on the far and near side of the intersection, whereas the Alternative System requires these traffic signal faces to be mounted only on the near side of the intersection.
  - (f) In the Recommended System the FLASHING RED DISC LIGHT SIGNAL used at railway crossings is displayed with a STOP sign R1; in the Alternative System a no STOP sign is used and a FLASHING WHITE DISC LIGHT SIGNAL may be used when no train is approaching.
- 3 Only the "Recommended Traffic Signal System" as used in South Africa is covered in this document. More details on the "Alternative Traffic Signal System" are given in Chapter 6 of Volume 1 of the Road Traffic Signs Manual.



## 1.5 TERMINOLOGY

- 1 A considerable effort has been made to ensure that the terminology used in this manual corresponds with normal traffic engineering practice. **In some instances, however, it was necessary to deviate from practice in order to preserve correspondence with other volumes of the manual, particularly with the National Road Traffic Act and Regulations.**
- 2 A glossary of terms is given in Appendix A of this manual. Most of the technical terms used in this manual (Volume 3) are listed in the glossary.
- 3 There are three words used throughout the Road Traffic Signs Manual - the interpretation of which is fundamental to the use of the manual. These words are the following:
  - (a) **“SHALL”** – a mandatory condition that means that the condition or conditions referred to must be complied with. In many instances, such requirements are not only stated in the manual, but also in the regulations.
  - (b) **“SHOULD”** – an advisory condition which means that it is advisable or recommended to comply with the condition or conditions referred to. Although there is a measure of interpretation in applying the condition, a road authority would be well advised to record why it has not conformed, if it chooses not to conform to the recommended action.
  - (c) **“MAY”** – a permissive condition that means that the conditions referred to are optional. The conditions are less specific and allow for actions that may be taken at the discretion of the road authority.
- 4 The legal significance of the above terms is important and must be understood by users of the manual. In the advent of legal actions, the failure to adhere to the intention of the manual as indicated above, could affect the outcome of such legal actions to the detriment of the authority.

## 1.6 ORGANISATION OF THE MANUAL

- 1 This manual (Volume 3) is subdivided into three main parts, namely:
  - (a) Part 1: Traffic signal control;
  - (b) Part 2: Traffic signal equipment; and
  - (c) Part 3: Traffic signal management.
- 2 Part 1 covers aspects related to the traffic control function of traffic signals. Topics such as light signals, traffic signal faces, junction and crossing layout as well as various applications of traffic signals are covered.
- 3 Part 2 covers aspects related to the equipment (hardware) used in traffic signals. Equipment is discussed in generic terms and reference to particular commercial systems is restricted. The intention is to provide a broad overview of signal equipment and no detailed technical specifications are included. Such specifications are provided by relevant SABS standard specifications.
- 4 Part 3 covers aspects related to the management of traffic signals. Aspects covered in this part include the duties and responsibilities of road authorities regarding traffic signals, management of liability risks, manpower requirements, maintenance management, etc.



## CHAPTER 2: TRAFFIC SIGNAL WARRANTS

### 2.1 INTRODUCTION

- 1 Traffic signals are one of the most common and widely accepted forms of traffic control and affect the daily lives of virtually all road users. Traffic signals can be very effective in improving traffic flow and facilitating access. However, traffic signals can also cause significant disbenefit and possible danger to road users when installed inappropriately.
- 2 There is unfortunately at times a tendency to use traffic signals indiscriminately in an attempt to solve problems where traffic signals are not appropriate. Traffic signals are often seen as the solution to almost all traffic problems, and pressures are often applied for the installation of unwarranted signals. The reasons cited are mostly subjective and emotional and are based on wrong perceptions of the function and abilities of traffic signals.
- 3 Contrary to popular belief, traffic signals do not always increase safety or reduce delay. In fact, the installation of traffic signals can result in the opposite, namely an increase in delay and a deterioration in safety. Although traffic signals would generally be of benefit to side-road traffic, this could be at a disproportional disbenefit to the main road traffic that previously had unimpeded right of way. It is only at relatively high volumes of side-road traffic where an overall improvement will be realised.
- 4 The warrants given in this chapter have the objective of avoiding the inefficiencies that can result from unnecessary and improper use of traffic signals. **The installation of traffic signals for the control of junctions and pedestrian or pedal cyclist crossings is warranted when:**
  - (a) **the traffic signals can meet all the *minimum requirements* described in this manual; AND**
  - (b) **no viable and feasible *alternative solution* is available which, when implemented, would obviate the need for traffic signals; AND**
  - (c) **the traffic signals meet the *queue length warrants* as described in this chapter.**
- 5 **There is no justification for keeping a traffic signal that does not meet ALL the above requirements. The removal of traffic signals at junctions and pedestrian or pedal cyclist crossings is warranted when any one of the above requirements is not met.**
- 6 A road authority may use the warrants to justify the installation and removal of signals. However, the fact that a signal is or is not warranted does not oblige the road authority to install or remove the traffic signal.
- 7 Procedures for the installation and removal of traffic signals are described in Chapters 26 and 27 of this manual. The study to establish whether such installation or removal of traffic signals is warranted, forms an important part of these procedures.

### 2.2 MINIMUM REQUIREMENTS

- 1 Traffic signals should only be installed when the other minimum requirements described in other chapters of this manual can be met, even if an engineering analysis indicates that signalisation is the optimum method of control and that traffic signals would meet the queue length warrants given in this chapter.
- 2 There are a large number of such minimum requirements, not all of which are listed below. The most important of these are the following:
  - (a) Speed limit - the speed limit on any approach to a signalised junction or pedestrian or pedal cyclist crossing shall NOT exceed 80 km/h.
  - (b) Visibility requirements - traffic signal faces should be clearly visible and recognisable on an approach to a traffic signal.

### 2.3 ALTERNATIVES TO TRAFFIC SIGNALS

- 1 The fact that the installation of traffic signals may be warranted in terms of the queue length warrants described in this chapter, does not mean that signalisation is the best or optimum solution to a specific problem. Alternative solutions that are viable and feasible and which, when implemented, would result in a situation in which the installation of traffic signals are no longer warranted, may obviate the need for traffic signals. Such alternatives should be thoroughly explored so that the best solution to the problem is found and applied.
- 2 Alternatives to traffic signalisation may include, but are not limited to, the following:
  - (a) Re-designing the geometry of an existing priority control junction to maximise traffic throughput and provide better safety. For instance, the provision of a separate right-turn lane on the stop or yield controlled approach is a particularly effective method of increasing the capacity of such a junction.
  - (b) The provision of a traffic circle or mini-circle would not only increase the capacity of the junction, but will also significantly improve traffic safety.
  - (c) Grade separation, if warranted by high volumes of traffic.
  - (d) Introduction of road closures, bans on turning movements, provision of one-way systems and other traffic management measures.
- 3 **The redistribution of traffic on the road network by means of traffic calming, road and street closures and one-way systems is a particularly effective and powerful way of reducing the number of traffic signals required in a network. It may be possible to channel traffic to a smaller number of junctions, or alternatively to junctions that are more suitable for signalisation.** Against this, the dangers of undesirable traffic intrusion or rat running in residential areas should always be recognised and avoided.

## 2.4 TRAFFIC SIGNAL WARRANTS

### 2.4.1 Introduction

- 1 Traffic signal warrants are used to indicate levels of activity above which signalisation is justified. Such warrants are used instead of economic analysis methods due to various reasons. Not only are traffic signal warrants easier to apply, but economic analysis also has a problem that it would often indicate that a signal is unjustified, even though there may be chronic congestion during periods with heavy traffic volumes.
- 2 A problem with traffic signals is that they are often only justified during periods with heavy traffic flow, while serious disbenefits can be incurred when signals are used during off-peak periods. In an economic analysis, the benefit achieved during peak periods can often not outweigh the disbenefit of operating traffic signals for the rest of the time.
- 3 One of the main advantages of traffic signals that is not normally taken into account in the economic analysis, is that signals distribute priority amongst more than one stream of vehicles, and that one stream of vehicles is not experiencing all the benefit of free flow. At a stop or yield controlled junction, the traffic on the stop or yield controlled approaches has no priority, while main road traffic can move freely through the junction. A traffic signal would result in a better distribution of benefits, although it could result in an overall disbenefit.
- 4 The levels of traffic activity above which signalisation is warranted have been established on the basis of experience over many years. In South Africa, as well as overseas, it has been found that when these levels are exceeded, delays become excessive and unacceptable to users, often resulting in an increase in traffic accidents.
- 5 Queue length is used in this manual as the norm for establishing whether the installation (or removal) of traffic signals is warranted.

### 2.4.2 Queue length warrants

- 1 **The INSTALLATION of a traffic signal is deemed warranted at a junction or pedestrian or pedal cyclist crossing when ANY one of the following three queue length warrants are met.**
  - (a) **WARRANT 1: The average length of ANY individual queue equals or exceeds four (4) over any one hour of a normal day.**
  - (b) **WARRANT 2: The SUM of the average lengths of all queues equals or exceeds six (6) over any one hour of a normal day.**
  - (c) **WARRANT 3: The SUM of the average lengths of all queues equals or exceeds four (4) over each of any eight hours of a normal day (the hours do not have to be consecutive, but they may not overlap).**

- 2 **The REMOVAL of a traffic signal at a junction or pedestrian or pedal cyclist crossing is warranted when NONE of the three queue length warrants given above can be met.** This warrant assumes that the existing traffic signal is efficiently timed and appropriate signal phases are used. Inefficient signal timings and inappropriate signal phases may result in excessive queues.
- 3 A pointsman or scholar patrol can be considered when a traffic signal is warranted for less than one full hour of the day.
- 4 In the event of a number of traffic signals being warranted, priority should be given to those locations with the longest queues.
- 5 The traffic signal warrants apply whether or not the signal will be vehicle-actuated or traffic responsive. While these modes of control are preferable at isolated or remotely located junctions, the application of such modes of control does not do away with the need for the traffic signal to be warranted.
- 6 The following notes must be read in conjunction with the above warrants:
  - (a) A queue may consist either of vehicles, pedestrians or cyclists stopped or waiting for service at the junction or crossing.
  - (b) An individual queue of vehicles is the queue waiting in a single lane. On multi-lane approaches, each lane of vehicles would be counted as a separate queue.
  - (c) An individual queue of pedestrians or pedal cyclists is the total number of pedestrians or pedal cyclists waiting to cross from one side to the other side of the junction or crossing. The pedestrians or pedal cyclists crossing in the opposite direction are counted as a separate individual queue.
  - (d) An hour must be measured over four consecutive 15-minute intervals, but the four intervals can be selected from any time of the day (normally the peak hour). The queue must be measured over the full hour.
  - (e) For the eight-hour warrant, the hours can be selected from any eight hours of four consecutive 15-minute intervals. The eight hours do not have to be consecutive, but they may not overlap.

### 2.4.3 Motivation for the queue length warrant

- 1 Traffic signal warrants have previously been simplistic, generalised statements giving thresholds for traffic volumes for typical ranges of traffic conditions at typical junctions and crossings. *Queue length* is introduced in this manual as a replacement for traffic volumes as the norm for warranting traffic signals.
- 2 Queue length has an advantage over traffic volume in that it is directly proportional to the **total** delay experienced at a junction or crossing. Another advantage of queue length is that it provides an indication of the potential accident hazard of such a junction or crossing. As queues build and delay increases, drivers are more likely to take chances, increasing the risk of accidents.

- 3 A further advantage of queue length is that it automatically compensates for the large variety of traffic, geometric and environmental factors that affect traffic operations at a junction or crossing. It is thus possible to establish only one queue length norm applicable to all conditions. This is in contrast with traffic volumes where different conditions require different norms. In many instances, traffic volume warrants are restricted to a specific set of conditions, while there is NO such restriction on queue length.
- 4 Additional advantages of queue length as a traffic signal warrant include the following:
  - (a) It takes into account delay and gap acceptance characteristics.
  - (b) It compensates automatically for the easier left turn movement at a priority controlled junction. Traffic volume warrants are established for one particular distribution of turning movements, and do not apply outside these parameters.
  - (c) It takes into account the number of approaches, gradients, sight distance, nearby driveways, pedestrians, and all other geometric conditions, possible distractions and difficulties.
  - (d) It takes into account the effect of heavy vehicles, buses and bus stops, loading and parking manoeuvres.
  - (e) By measuring vehicle, pedestrian and pedal cyclist queues together, the different characteristics of these travel modes can be combined.
  - (f) By including pedestrian and pedal cyclist queues, the speed and gap acceptance characteristics of these users are compensated for.
  - (g) When a junction is seen or perceived to be dangerous, drivers will be cautious and not proceed until satisfied that the way is clear. This will result in queues building faster than normal, even though traffic volumes may be low.
  - (h) Account is taken of the fact that it is generally easier to cross a single lane road than a multi-lane road carrying the same volume of traffic.
- 5 A further important advantage of the queue length warrant is that it is possible to quickly identify candidate locations that may warrant either the installation of new traffic signals or the removal of existing signals. A casual observer can readily observe queue lengths over a short period of time. Detailed warrant studies can then be undertaken once such candidate locations have been identified.

#### 2.4.4 Measuring queue lengths

- 1 The average queue length required for the warrant analysis can be established in one of two ways:
  - (a) Field observations.
  - (b) Traffic modelling.
- 2 Field observations are always more accurate than traffic modelling, particularly at priority controlled junctions or pedestrian or pedal cyclist crossings where traffic operations can be affected by a large number of factors. Field observations are therefore generally preferable to traffic modelling for establishing queue lengths.
- 3 When the possible removal of traffic signals is investigated, at least eight hours of observations would be required to establish whether such removal is warranted.

#### 2.4.5 Field observations of queue lengths

- 1 Queue lengths at junction or crossing are observed by counting the number of vehicles, pedestrians or pedal cyclists waiting to be served at a junction or crossing. Each **individual** queue of traffic should be counted separately. The definition of an individual queue is given as part of the warrants.
- 2 Queue lengths are counted at regular time intervals of typically 15, 30 or 60 seconds. The appropriate time interval depends on whether traffic patterns on the main road (road without stop or yield control) are random or platooned due to the presence of nearby traffic signals:
  - (a) When traffic on the main road is heavily platooned due to the presence of nearby traffic signals, a time interval of 15 seconds would typically be used. However, should queues become so long that it is difficult to count the queue length, a longer time interval of about 30 seconds may be used.
  - (b) Where traffic on the main road is slightly platooned due to the presence of traffic signals on the main road, a time interval of 30 seconds may typically be used.
  - (c) When traffic on the main road is random with no discernible platoons formed due to traffic signals on the main road, a time interval of 60 seconds may typically be used.
- 3 **It is important to note that queue length should be counted as quickly as possible at the end of a time interval, and not during the time interval. The queue length is required at a point in time rather than over a period of time, as shown in Figure 2.1.**
- 4 **The average queue length is calculated by adding together the observed queue lengths during a time interval (including zero queue lengths) and dividing the sum by the number of observations. An example of such calculations is shown in Figure 2.1.**

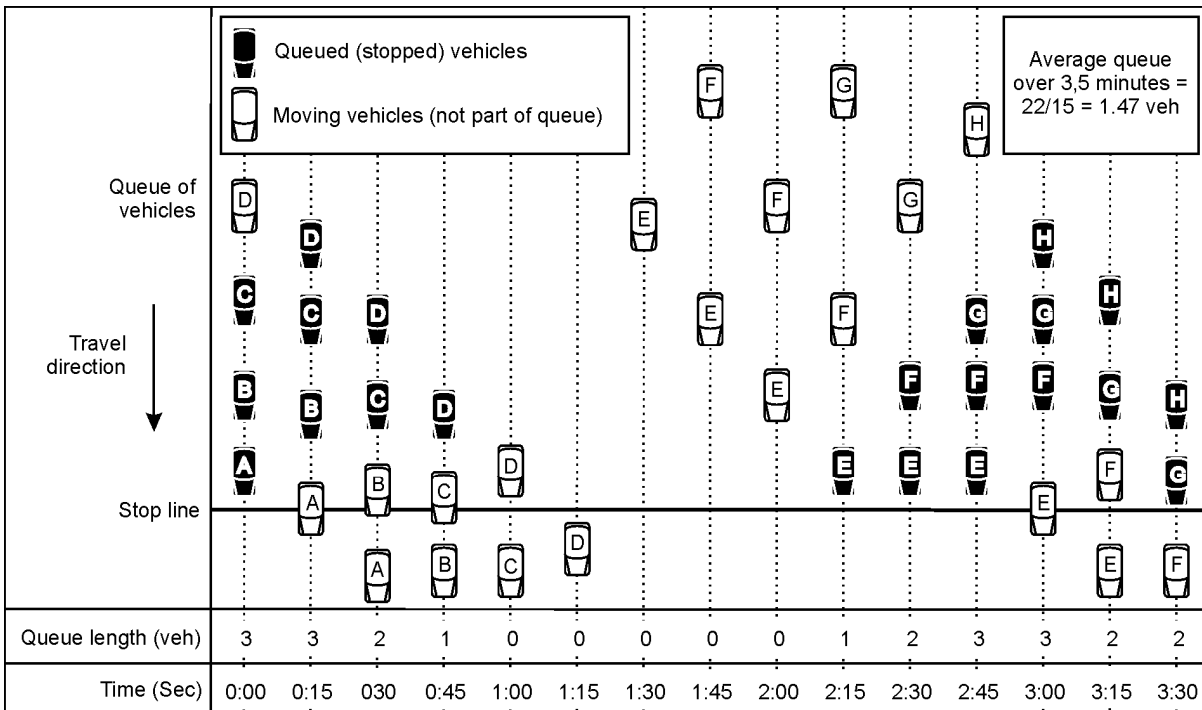

Figure 2.1: Queue length observations

- 5 The field observations can be significantly simplified by providing observers with an electronic watch and bleeper. The watch should show time to the nearest second and should sound bleeps every 15 seconds. One bleep is sounded at 0 seconds, two at 15 seconds, three at 30 seconds and four at 45 seconds.
- 6 Observers should be carefully trained. It is recommended that a video recording of a queue at a junction or crossing be used during the training. Each observer should be tested carefully to determine whether he or she understands the procedure of counting queue lengths exactly. Some observers who are used to counting traffic volumes, find it difficult to adjust to queue length counts since queue lengths are counted at the end of an interval, while traffic volumes are counted during the interval.

#### 2.4.6 Traffic modelling of queue lengths

- 1 It is not always possible to undertake field observations of queue lengths, and traffic modelling will then have to be resorted to. Field observations of queue lengths, for instance, are not possible at new junctions that have not yet been constructed. This would typically occur when a new development is planned. During the Traffic Impact Study required to establish the impact of such development, the need for additional traffic signals at new accesses or junctions must be established based on traffic modelling and using the traffic signal warrants.
- 2 Traffic modelling will also be required where changes to the road network, or the installation of a new traffic signal, would result in a redistribution of traffic in an area. A newly signalised road junction may attract drivers from nearby priority controlled junctions who may find that by diverting to the signalised junction, they experience less delay. These scenarios would entail a more rigorous traffic planning analysis with the purpose of estimating the likely traffic volumes at the junction or crossing being evaluated.

- 3 A variety of computer traffic models are available, although some manual methods are also used. The estimation of queue lengths by means of a traffic model is a complex exercise and should be undertaken with circumspect. All traffic models are based on some idealised representation of reality, which may, or may not, be representative of actual traffic operations. Some models are more accurate than others, but all models have limitations. The results of such models should therefore be used with caution.
- 4 Some models can calculate average queue lengths directly. Some models calculate 90<sup>th</sup> or 95<sup>th</sup> percentile queue lengths. These should not be used, **as it is the average queue length that is required**. Where queue lengths are only provided per approach and not by lane, such queue lengths should be divided by the number of lanes on the approach to establish the average queue length per lane.
- 5 Some models only provide average delay as output and not queue length. The average queue length can then be calculated by means of the following formula:

$$N_i = \frac{D_i \cdot Q_i}{3600}$$

in which:

- $N_i$  = Average queue length in lane i.  
 $D_i$  = Average delay of vehicles in lane i in units of seconds/vehicle, excluding acceleration and deceleration delay.  
 $Q_i$  = Arrival flow rate in lane i in units of vehicles/hour/lane.

#### 2.4.7 Normal days

- 1 An important consideration in establishing queue lengths, is that such queues should be established for a normal day rather than for an exceptional day.
- 2 A normal day is one on which traffic flow is relatively stable, unaffected by events such as traffic accidents, road closure, construction, inclement weather, special sporting events and during school terms. Exceptional days include public and school holidays, as well as days on which traffic patterns are abnormal due to the conditions as mentioned above. More information on normal and exceptional days is given in Chapter 29 of this manual.
- 3 Traffic counts and queue length observations should be discontinued or discarded when an exceptional event has occurred that may have affected the observations.





## CHAPTER 3: TRAFFIC SIGNAL FACES

### 3.1 INTRODUCTION

- 1 The traffic light signal is the means by which a traffic signal communicates with the driver. This communication is of fundamental importance for the efficient and safe operation of a traffic signal installation.
- 2 Due to the importance of the traffic light signal and signal faces in the communication with drivers, light signals and faces are regulated by the **National Road Traffic Regulations**, while minimum requirements are given in Chapter 6 of Volume 1 of the **Road Traffic Signs Manual**. It is important that these regulations and standards shall be strictly adhered to in order to ensure uniform and safe traffic signalling.

### 3.2 LIGHT SIGNALS AND FACES

- 1 The *light signal* is the basic element of communication with the road user. A light signal consists of a single illuminated signal aspect and can be coloured green, yellow or red. A signal aspect is the lamp unit that displays a light signal when illuminated.
- 2 A vehicular light signal can be either a *disc* or an *arrow* light signal. Special light signals are also available for the control of *buses, trams, pedestrians* and *pedal cyclists* (as well as reversible lanes).
- 3 The vehicular disc light signal applies to ALL traffic movements, while the arrow (or a disc light signal combined with the Traffic Signal Arrow Sign ST1 to ST5) applies only to a particular turning movement or movements.
- 4 A light signal can also be either *steady* or *flashing*.
- 5 At traffic signals where no *pedestrian* signals are provided, the vehicular light signals will also apply to pedestrians.
- 6 The *traffic signal face* contains a number of signal aspects in particular arrangements. Standard traffic signal faces are prescribed and only those signal faces SHALL be used in traffic signal installations.

### 3.3 AREA OF CONTROL

- 1 Traffic signals, as defined by the National Road Traffic Regulations, shall control traffic only at a junction or a pedestrian or pedal cyclist crossing. The signals shall control ALL approaches to the junction or crossing.
- 2 A JUNCTION is defined by the National Road Traffic Regulations **"as that portion of an intersection contained within the prolongation of the lateral limits of the intersecting roadways and include any portion of the roadway between such lateral limits, and any stop or yield line marking which is painted at such intersection"**.
- 3 An INTERSECTION is defined by the regulations as the **"the area embraced within the prolongation of the lateral boundary lines of two or more public roads, open to vehicular traffic, that join one another at any angle, whether or not one such public road crosses the other"**.

- 4 The above definition of a junction allows for the provision of slipways adjacent to the junction that can be controlled independently of the main junction. A SLIPWAY is a roadway that passes to the left (or in the instance of one-way systems, to the right) of the main junction without intersecting the main junction. The regulations, however, require that **"a slipway for traffic turning left or right at a junction which is traffic signal controlled, shall be separated from the lane to the right or left of such slipway by a constructed island"**.
- 5 A slipway that is signal controlled would normally only have signals controlling the slipway, and any potential conflicts must be prevented at the main junction. All conflicting movements at the main junction, including the right-turn movement from the opposite direction, must face a RED LIGHT SIGNAL while the slipway receives a GREEN SIGNAL.
- 6 A PEDESTRIAN CROSSING is defined by the National Road Traffic Regulations as **"a) any portion of a public road designated as a pedestrian crossing by appropriate road traffic signs or b) that portion of a public road at an intersection included within the prolongation or connection of the kerb line and adjacent boundary line of such road, when no pedestrian crossing has been designated by appropriate road traffic signs"**.
- 7 The above definitions are illustrated in Figure 3.1. The figure shows an intersection defined by the boundary lines of the two intersecting roads. Two junctions are also shown in the figure, the main junction as well as a slipway junction. A number of marked pedestrian crossings as well as one unmarked pedestrian crossing are also shown. **Pedestrian crossings are always defined at junctions (whether they are marked or not), except when pedestrians are specifically prohibited from crossing the junction.**

### 3.4 CONTROL PRECEDENCE

- 1 According to the National Road Traffic Regulations, **"the traffic control at a junction or pedestrian or pedal cyclist crossing may include the use of road signs, road markings and road signals and the control precedence SHALL be as follows:**
  - (a) **A road sign which prohibits or prescribes directional movement of traffic at a junction or pedestrian or pedal cyclist crossing which is controlled by a traffic signal, shall have precedence over any light signal which permits right of way.**
  - (b) **A light signal that permits right of way shall have precedence over the stop line RTM1;**

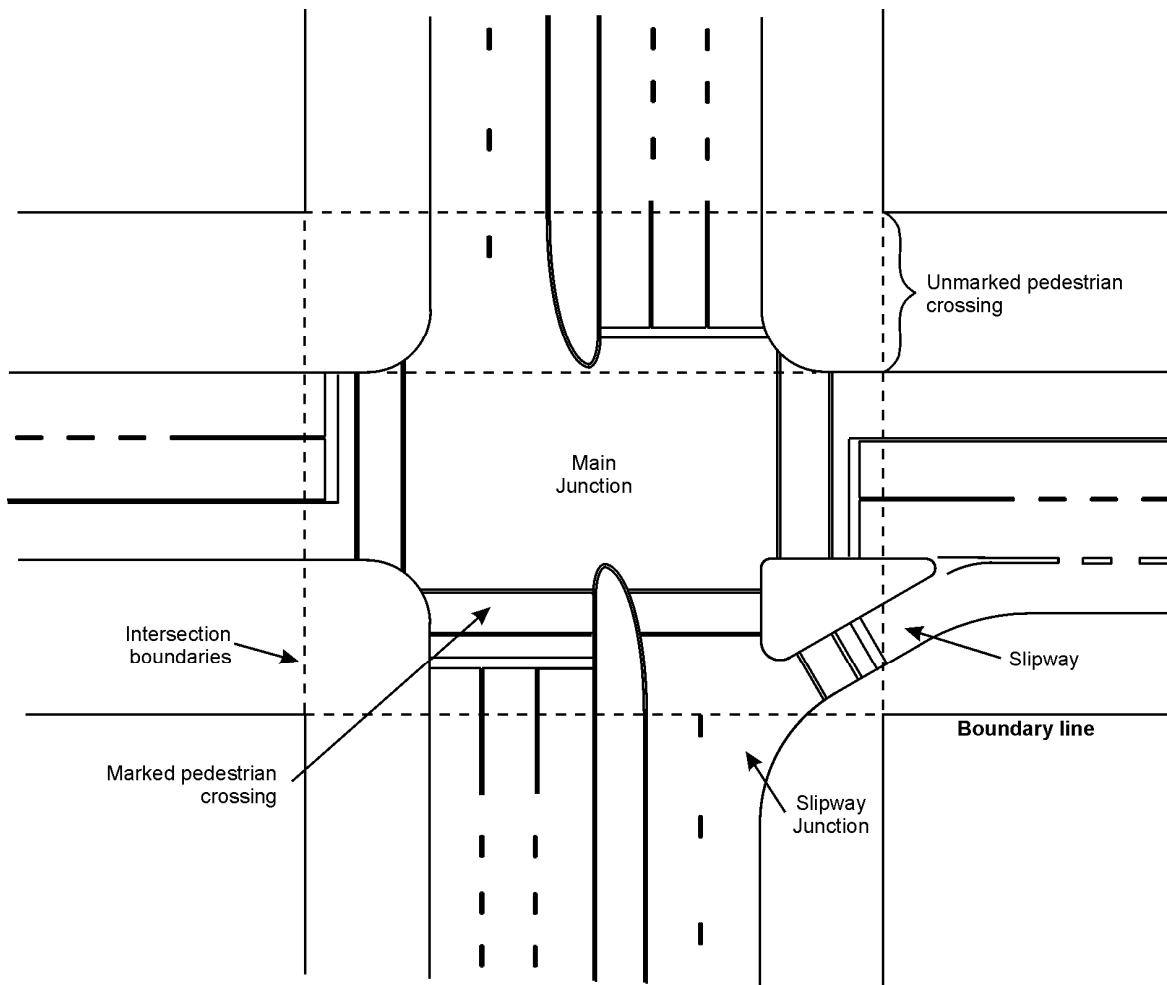

Figure 3.1: Definition of intersections, junctions, slipways and pedestrian crossings

- (c) **A light signal that has the significance that traffic shall stop, has precedence over any other road traffic sign or another light signal that permits right of way, EXCEPT when such other light signal (permitting right of way) has a higher precedence level. The precedence levels for light signals are as follows, given from the highest to lowest precedence level:**
- (i) **steady or flashing pedestrian and pedal cyclist light signals;**
  - (ii) **steady or flashing bus or tram light signals;**
  - (iii) **steady or flashing arrow signals, or steady disc signals with traffic signal arrow signs ST1 to ST5; and**
  - (iv) **steady disc light signals”.**
- 2 The National Road Traffic Regulations require that **”NO road sign except –**
- (a) **a street name sign;**
  - (b) **a direction route marker sign;**
  - (c) **information signs IN14, IN15 and pedestrian and pedal cyclist signs relating to the function of the traffic signal;**
  - (d) **a one-way roadway sign;**
  - (e) **a no-entry sign;**
  - (f) **a left-turn prohibited, right-turn prohibited or a U-turn prohibited sign;**
  - (g) **a proceed straight through only, proceed left only, or proceed right only sign;**
  - (h) **a pedestrian prohibited sign R218; or**
  - (i) **a traffic signal arrow sign ST1 to ST5;**
- SHALL be used in conjunction with a traffic signal, and such signs may be mounted on the same post or overhead cantilever or gantry as that of the traffic signal”.** Examples of such signs are shown in Figure 3.2.

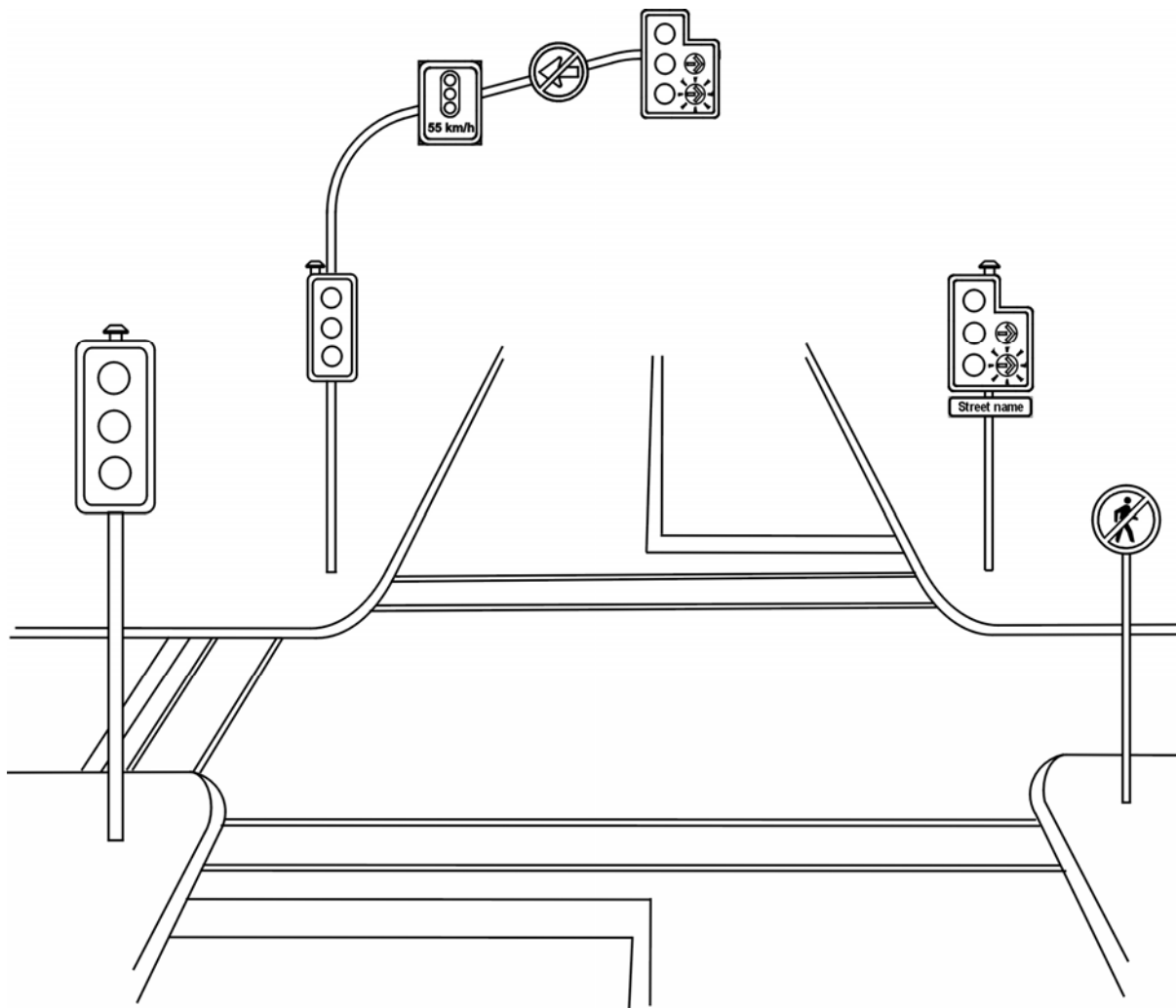

Figure 3.2: Examples of road signs used in conjunction with traffic signals

- 3 The following signs, in particular, may NOT be used in conjunction with a traffic signal, even if the signal is out of order (however, the signs may be used when the traffic signal has been masked out):
  - (a) STOP sign R1 or any of its derivatives.
  - (b) YIELD sign R2.
  - (c) RIGHT-OF-WAY sign IN7.
  - (d) Any sign that conflicts with or gives right of way over the traffic signal.
- 4 According to the definition of a junction, a slipway at a signalised junction is defined as a separate junction, operating independently of the main junction. A slipway therefore can be STOP or YIELD controlled as it is regarded as a separate junction.
- 5 The PEDESTRIAN PROHIBITED SIGN R218 is used to prohibit pedestrians from proceeding beyond the sign. The sign must be posted on the near side of the junction, in the direction to which it is applicable (and in both directions of the crossing).
- 6 TRAFFIC SIGNAL ARROW SIGNS ST1 to ST5 may be used in conjunction with traffic signals. According to the National Road Traffic regulations, the signs "*indicate to the driver of a vehicle, when displayed vertically above a traffic signal face, that any light signal installed in such face only applies to the direction of movement indicated by the arrow*".

### 3.5 VEHICULAR LIGHT SIGNALS

#### 3.5.1 General requirements

- 1 Vehicular light signals are described in the following sections. Appropriate combinations of the light signal may be used at a signalised road junction or pedestrian or pedal cyclist crossing.
- 2 The following basic sequence of vehicular light signals shall be used on each approach road to a signalised junction or pedestrian or pedal cyclist crossing, and on each traffic signal face:
  - (a) a FLASHING or STEADY GREEN LIGHT SIGNAL, followed by:
  - (b) a STEADY YELLOW LIGHT SIGNAL followed by:
  - (c) a STEADY RED LIGHT SIGNAL, where it is provided on a signal face (not provided on S10L, S10R, S10B and S10T signal faces).
- 3 On the S9 and S10L traffic signal faces, the STEADY YELLOW ARROW LIGHT SIGNAL may be omitted from the signal sequence subject to the conditions that:
  - (a) the FLASHING GREEN ARROW LIGHT SIGNAL must immediately be followed by a STEADY GREEN LIGHT SIGNAL which allows the left-turn movement to turn; and
  - (b) when pedestrian or pedal cyclist signals are provided, no GREEN PEDESTRIAN or PEDAL CYCLIST LIGHT SIGNAL may be displayed following the flashing green arrow light signal. The yellow arrow light signal shall NOT be omitted when such green pedestrian or pedal cyclist light signal is displayed.
- 4 **Light signals of different colours shall NOT be displayed at the same time to the same turning movement. A driver may, for example, not receive a red signal at the same time as a yellow or green signal (even at a staggered or very wide junction).**
- 5 Under no circumstances SHALL a GREEN LIGHT SIGNAL be used at some times in a STEADY mode and other times in a FLASHING mode. A RED LIGHT SIGNAL, however, may be used in both flashing and steady modes. The YELLOW LIGHT SIGNAL may under no circumstances be used in flashing mode on a traffic signal face.
- 6 When traffic signals are not in operation, such as during installation, all traffic signal faces SHALL be suitably **masked** so as to obscure them from the sight of drivers, pedestrians or pedal cyclists. Advance information signs relating to the signal shall also be masked. While the traffic signal is not operational, each non-priority side road approach to the junction shall be controlled by a STOP sign R1, or a YIELD sign R2, or all approaches shall be controlled by all-way STOP signs R1.3 or R1.4. These signs shall be removed immediately once the traffic signal has come into operation.
- 7 The meanings assigned to vehicular light signals given in the following subsections are quoted directly from the National Road Traffic Regulations.

#### 3.5.2 Red vehicular light signals

- 1 A STEADY RED DISC LIGHT SIGNAL (without a traffic signal arrow sign ST1 to ST5) indicates ***“to the driver of a vehicle that he or she shall stop his or her vehicle behind the stop line RTM1 and that he or she shall remain stationary until a green light signal is displayed, and it is safe to proceed, and in the event that a pedestrian light signal is not provided, indicates to a pedestrian that he or she shall not cross the roadway until a green light signal is displayed and it is safe to do so”***.
- 2 A STEADY RED BUS LIGHT SIGNAL indicates ***“to the driver of a vehicle allowed in an exclusive bus lane that he or she shall stop his or her vehicle behind the stop line RTM1 and that he or she shall remain stationary until a green bus light signal is displayed, and it is safe to proceed”***.
- 3 A STEADY RED TRAM LIGHT SIGNAL indicates ***“to the driver of a vehicle allowed in an exclusive tram lane that he or she shall stop his or her vehicle behind the stop line RTM1 and that he or she shall remain stationary until a green tram light signal is displayed, and it is safe to proceed”***.
- 4 A STEADY RED DISC LIGHT SIGNAL WITH A TRAFFIC SIGNAL ARROW SIGN ST1 to ST5 INSTALLED ABOVE THE SIGNAL indicates ***“to the driver of a vehicle that he or she shall stop his or her vehicle behind the stop line RTM1 if he or she intends turning in the direction indicated by” ... “the traffic signal arrow sign and that he or she shall remain stationary until a green light signal is displayed that allows movement in the direction of the arrow and it is safe to proceed”***.
- 5 A FLASHING RED DISC, BUS OR TRAM LIGHT SIGNAL indicates ***“to the driver of a vehicle that he or she shall act as for a 3-way stop sign R1.3 or 4-way stop sign R1.4 and shall yield right of way to all pedestrians crossing his or her path, and the signal indicates to a pedestrian that he or she may cross the roadway if it is safe to do so”***. This use of this signal shall be SUBJECT TO THE FOLLOWING CONDITIONS:
  - (a) It shall NOT be displayed at the same time as ANY other light signal on any approach road, and the pedestrian and pedal cyclist signals shall be switched off (except when a pelican phase is provided).
  - (b) At a pedestrian crossing it may be used during a "Pelican" phase to indicate to drivers of vehicles that pedestrians may be clearing the road and have right of way. During this phase, the FLASHING RED LIGHT SIGNAL may be displayed only at the same time as the FLASHING RED MAN or PEDAL CYCLIST RED LIGHT SIGNAL. **Pedestrians or pedal cyclists may not enter the crossing on the flashing red signal, and the duration of this interval should therefore NOT exceed the time required to clear the crossing.** Information on the timing of pedestrian and pedal cyclist signals is given in Chapter 4 of this manual.

### 3.5.3 Yellow vehicular light signals

- 1 A STEADY YELLOW DISC LIGHT SIGNAL indicates ***“to the driver of a vehicle that he or she shall stop his or her vehicle behind the stop line RTM1 and that he or she shall remain stationary until a green light signal is displayed, and it is safe to proceed; provided that if he or she is so close to a stop line RTM1 when the steady yellow disc light signal is displayed that he or she cannot stop safely, he or she may proceed with caution against such yellow light signal, and in the event that a pedestrian light signal is not provided, indicates to a pedestrian that he or she shall not cross a roadway until a green light signal is displayed and it is safe to do so”***. The use of this signal shall be SUBJECT TO THE FOLLOWING CONDITIONS:
  - (a) It shall NOT be displayed to right-turning traffic at the same time as a GREEN LIGHT SIGNAL is displayed to traffic on the conflicting opposing approach. This means that a phase allowing traffic to turn right may not be terminated while a green light signal is still being displayed on the conflicting opposing approach (Right-turning traffic receiving yellow may not know that the opposing traffic is still receiving green and may turn right into the face of oncoming traffic).
  - (b) It should be followed by a clearance or all-red interval to allow vehicles to clear the junction before green light signals are displayed to conflicting traffic movements.
  - (c) The duration of the yellow and clearance or all-red intervals is calculated using procedures given in Chapter 6 of this manual (Volume 3).
  - (d) An enforcement tolerance should be provided during the all-red interval to accommodate drivers who are unable to stop during the yellow interval. Law enforcement should only commence during the last one second of the all-red interval.
- 2 A STEADY YELLOW BUS LIGHT SIGNAL indicates ***“to the driver of a vehicle allowed in an exclusive bus lane that he or she shall stop his or her vehicle behind the stop line RTM1 and that he or she shall remain stationary until a green light signal is displayed, and it is safe to proceed; provided that if he or she is so close to a stop line RTM1 when the steady yellow bus light signal is displayed that he or she cannot stop safely, he or she may proceed with caution against such yellow light signal”***. The use of this light signal is SUBJECT TO THE CONDITIONS given for the STEADY YELLOW DISC LIGHT SIGNAL.
- 3 A STEADY YELLOW TRAM LIGHT SIGNAL indicates ***“to the driver of a vehicle allowed in an exclusive tram lane that he or she shall stop his or her vehicle behind the stop line RTM1 and that he or she shall remain stationary until a green light signal is displayed, and it is safe to proceed; provided that if he or she is so close to a stop line RTM1 when the steady yellow tram light signal is displayed that he or she cannot stop safely, he or she may proceed with caution against such yellow light signal”***. The use of this light signal is SUBJECT TO THE CONDITIONS given for the STEADY YELLOW DISC LIGHT SIGNAL, except that the duration of the yellow and clearance intervals must be adjusted to accommodate the operational characteristics of the tram.
- 4 A STEADY YELLOW ARROW LIGHT SIGNAL indicates ***“to the driver of a vehicle that he or she shall stop his or her vehicle behind the stop line RTM1 if he or she intends turning in the direction indicated by the yellow arrow light signal and that he or she shall remain stationary until a green light signal allowing the movement is displayed, and it is safe to proceed; Provided that if he or she is so close to stop line RTM1 when a steady yellow arrow light signal is displayed that he or she cannot stop safely then he or she may proceed with caution against such yellow arrow light signal”***. The use of this light signal is SUBJECT TO THE CONDITIONS given for the STEADY YELLOW DISC LIGHT SIGNAL.

### 3.5.4 Green vehicular light signals

- 1 A STEADY GREEN DISC LIGHT SIGNAL indicates ***“to the driver of a vehicle that he or she may proceed through a junction or crossing, or turn to the left or right, subject to any restricting road traffic sign or light signal, but shall yield right of way to other vehicular traffic and to pedestrians lawfully within the junction or crossing, at the time a steady green disc light signal is displayed, and in the event that a pedestrian light signal is not provided, to indicate to a pedestrian that he or she may cross the junction within the pedestrian crossing markings RTM3 or RTM4 as appropriate, provided that a conflicting flashing green arrow, bus or tram light signal is not displayed at the same time”***. The use of this signal is SUBJECT TO THE FOLLOWING CONDITIONS:
  - (a) It shall NOT be displayed at the same time on the same approach as a STEADY GREEN ARROW LIGHT SIGNAL.
  - (b) With the exception of the S12 traffic signal face, it shall NOT be displayed for a duration less than 7 seconds (preferably not less than 11 seconds).

- 2 A STEADY GREEN BUS LIGHT SIGNAL indicates ***“to the driver of a vehicle allowed in an exclusive bus lane that he or she may proceed through a junction or crossing, or turn to the left or right, subject to any restricting road traffic sign or light signal, but shall yield right of way to other vehicular traffic and to pedestrians lawfully within the junction or crossing, at the time such steady green bus light signal is displayed”***. The use of this signal is SUBJECT TO THE CONDITION that it shall NOT be used to indicate a FLASHING GREEN BUS LIGHT SIGNAL at another time.
- 3 A STEADY GREEN TRAM LIGHT SIGNAL indicates ***“to the driver of a vehicle allowed in an exclusive tram lane that he or she may proceed through a junction or crossing, or turn to the left or right, subject to any restricting road traffic sign or light signal, but shall yield right of way to other vehicular traffic and to pedestrians lawfully within the junction or crossing, at the time such steady green tram light signal is displayed”***. The use of this signal is SUBJECT TO THE CONDITION that it shall NOT be used to indicate a FLASHING GREEN TRAM LIGHT SIGNAL at another time.
- 4 A STEADY GREEN ARROW LIGHT SIGNAL indicates ***“to the driver of a vehicle that he or she may proceed in the direction indicated by the steady green arrow light signal, subject to any restricting road traffic sign or light signal, but shall yield right of way to other vehicular traffic and to pedestrians lawfully within the junction or crossing, at the time such green light signal is displayed and in the event that a pedestrian light signal is not provided, indicates to a pedestrian that he or she may cross the junction within the pedestrian crossing markings RTM3 or RTM4 as appropriate, provided that a conflicting flashing green arrow, bus or tram light signal is not displayed at the same time”***. The use of this signal is SUBJECT TO THE FOLLOWING CONDITIONS:
- It should preferably only be used to indicate the direction of ONE-WAY roads or streets.
  - It shall NOT be used when there is a conflicting traffic movement from the opposite direction (the movement is opposed). The STEADY GREEN RIGHT ARROW LIGHT SIGNAL, in particular, may NOT be used when there is an opposing traffic movement (e.g. on two-way roads).
  - It shall NOT be displayed at the same time on the same approach as a STEADY GREEN DISC LIGHT SIGNAL.
- A maximum of two STEADY GREEN ARROW LIGHT SIGNALS, showing in different directions, may be located in one signal face.
  - It shall NOT be used to indicate a FLASHING GREEN ARROW LIGHT SIGNAL at another time.
  - It shall not be displayed for a duration less than 7 seconds (preferably not less than 11 seconds).
- 5 A FLASHING GREEN BUS LIGHT SIGNAL indicates ***“to the driver of a vehicle allowed in an exclusive bus lane that he or she may proceed and that his or her movements are unopposed by other traffic”***. The use of this light signal is SUBJECT TO THE CONDITIONS given for the FLASHING GREEN ARROW LIGHT SIGNAL except that it shall NOT be used to indicate a STEADY GREEN BUS LIGHT SIGNAL at another time.
- 6 A FLASHING GREEN TRAM LIGHT SIGNAL indicates ***“to the driver of a vehicle allowed in an exclusive tram lane that he or she may proceed and that his or her movements are unopposed by other traffic”***. The use of this light signal is SUBJECT TO THE CONDITIONS given for the FLASHING GREEN ARROW LIGHT SIGNAL except that it shall NOT be used to indicate a STEADY GREEN TRAM LIGHT SIGNAL at another time.
- 7 A FLASHING GREEN ARROW LIGHT SIGNAL indicates ***“to the driver of a vehicle that he or she may proceed in the direction indicated by the flashing green arrow light signal and that his or her movement is unopposed by other traffic”***. The use of this signal is SUBJECT TO THE FOLLOWING CONDITIONS:
- It shall NOT be used to indicate a STEADY GREEN ARROW LIGHT SIGNAL at another time.
  - It SHALL be displayed only when the indicated movement is protected and no opposing or conflicting vehicular, pedestrian or pedal cyclist movement has explicit or priority right of way. Conflicting movements through the junction shall face RED LIGHT SIGNALS.
  - When no pedestrian signal is provided, pedestrians do not have right of way when the FLASHING GREEN ARROW LIGHT SIGNAL is displayed. However, separate pedestrian signals for the control of pedestrians are recommended at junctions where such signals are displayed. Alternatively, pedestrian movements may be prohibited by means of PEDESTRIAN PROHIBITED SIGNS R218.
  - It shall NOT be displayed for a duration less than 4 seconds (preferably not less than 7 seconds).

### 3.6 FLASHING AND OTHER MODES OF OPERATIONS

- 1 Flashing and other modes of operations include:
  - (a) FLASHING RED LIGHT SIGNALS on ALL approaches.
  - (b) No light signal illuminated (signals switched off).
  - (c) Manual signal advance, whereby the timing of green light signals can be changed manually.
- 2 The operations at the signal when light signals are flashing red or when the light signals are not illuminated, are similar to that of a 3- or 4-way STOP controlled junction. According to the National Road Traffic Regulations, ***"when no light signal is illuminated on an approach to a signalised junction, the driver of a vehicle shall act as for a 3-way stop sign R1.3 or a 4-way stop sign R1.4"***.
- 3 According to the National Road Traffic Regulations, ***"a traffic signal may be placed in a mode of operation indicating that it is out of order, and this mode of operation shall be that either all the light signals shall not be illuminated, or that all vehicular red light signals shall be flashing and pedestrian and pedal cyclist light signals shall be switched off"***.
- 4 **At no time SHALL an operational traffic signal be intentionally switched off**, other than for maintenance or repairs or when controlled by a traffic officer or an authorised pointsman (part-time operation of traffic signals is NOT allowed).
- 5 A traffic officer or an authorised pointsman may intervene with the operation of a traffic signal. The traffic signal may then be placed in any one of the above modes of operation.
- 6 The planned operation of traffic signals in flashing mode for part of the day or night, in place of normal traffic signal operations, is not recommended. Under conditions of low traffic flow, the following alternatives should first be considered:
  - (a) Reduce cycle length, but with pedestrian phases still available on demand (in which case the cycle length may have to be increased to accommodate pedestrian crossing times).
  - (b) Vehicle-actuated control.
- 7 It is recommended that, where and when possible, a traffic signal should be placed in a flashing mode of operation or switched off by first introducing STEADY RED LIGHT SIGNALS on all traffic signal faces for a duration of at least 3 to 5 seconds.
- 8 The traffic signal should again be returned to the normal mode of operations, or switched on, by using one of the following methods:
  - (a) A FLASHING RED LIGHT SIGNAL should be followed by a STEADY RED LIGHT SIGNAL for a duration of between 3 and 5 seconds. This steady red light signal in turn, should, be followed by a GREEN LIGHT SIGNAL on the main road (where possible).
  - (b) A switched-off traffic signal should be switched on again by first displaying FLASHING RED LIGHT SIGNALS for a duration of not less than 5 seconds, followed by STEADY RED LIGHT SIGNALS for a duration of between 3 and 5 seconds, followed by a GREEN LIGHT SIGNAL on the main road (where possible).

### 3.7 ARRANGEMENT OF LIGHT SIGNALS ON A SIGNAL FACE

- 1 The number and positioning of light signals on a traffic signal face SHALL conform to one of the standard traffic signal face arrangements shown in Figure 3.3. The relative position of each light signal relative to the others on a particular traffic signal face is of significance in the interpretation of the meaning of light signals.
- 2 The RED, YELLOW and GREEN LIGHT SIGNALS on a traffic signal face that contains three or more light signals, shall be positioned in line vertically with the RED LIGHT SIGNAL at the top, the YELLOW LIGHT SIGNAL immediately below the red and the GREEN LIGHT SIGNAL immediately below the yellow signal. If there is a second GREEN ARROW LIGHT SIGNAL it shall be located in line vertically below the first green arrow signal. A straight-ahead arrow shall be located above a right or left arrow and a right arrow shall be located above a left.
- 3 The YELLOW and GREEN LIGHT SIGNALS on a traffic signal face that contains two light signals, shall be positioned in line vertically with the YELLOW LIGHT SIGNAL at the top and the GREEN LIGHT SIGNAL immediately below the yellow signal.
- 4 When vehicular signal faces are mounted adjacent to each other in a horizontal group, all light signals of the same colour must be located on the same horizontal level (as shown in Figure 3.7), except that for S5, S6, S7 traffic signal faces, the second green arrow light signal may be located immediately below the level of the green light signals.
- 5 No light signal shall be located at the same level as a light signal of a different colour (except for pedestrian or pedal cyclist light signals).
- 6 **DUPLICATE light signals shall NOT be provided in a traffic signal face.** Providing such light signals would mean that the signal face no longer conform to one of the standard traffic signal faces of Figure 3.3. Where increased conspicuity is required, additional standard traffic signal faces may be provided.

### 3.8 STANDARD SIGNAL FACES

- 1 Standard traffic signal faces are prescribed by the National Road Traffic Regulations. The standard faces are shown in Figure 3.3 and in the colour plate provided at the beginning of this manual (Volume 3). All traffic signal faces SHALL conform to one of the standards, and no other faces may be used.
- 2 The standard traffic signal faces have been developed to ensure uniformity and adequate comprehension by road users. They will meet all practical signal requirements and applications. The use of any other signal face arrangements is not necessary and is NOT allowed.
- 3 TRAFFIC SIGNAL FACES S16 to S19 are used for individual lane control and are discussed in Chapter 13 of this manual (Volume 3). The faces are included in Figure 3.3 to indicate that they form part of the numbering system.
- 4 Dimensions for the standard traffic signal faces are given in Volume 4 of the Road Traffic Signs Manual and in the standard specifications SANS 1459: *Traffic lights*.

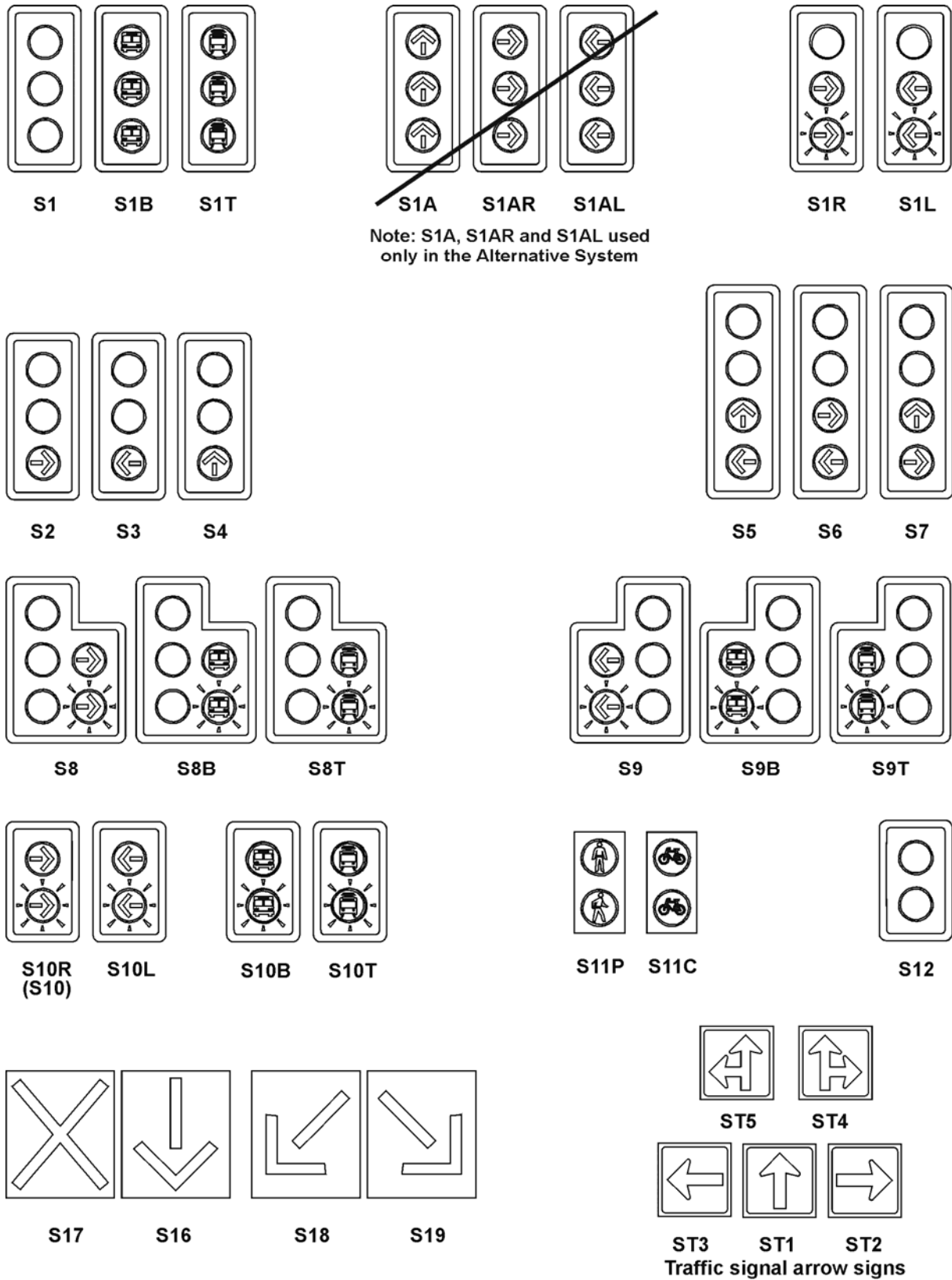

Figure 3.3: Standard traffic signal faces and traffic signal arrow signs



- 5 TRAFFIC SIGNAL ARROW SIGNS ST1 to ST5 may be used to indicate the directions in which light signals are applicable. The use of the signs is subject to the following conditions:
- The signs shall ONLY be used when it is necessary to assign to traffic signal faces S1L and S1R a higher precedence level (using signs ST3 and ST2 respectively).
  - When the arrow signs are used with the S1L and S1R signal faces, arrow signs may optionally also be used with signal faces S1, S2, S3, S4, S5, S6 and S7. However, when these signal faces are erected immediately adjacent to the S1L and S1R signal faces (typically on the same post), the use of arrow signs with the signal faces is recommended as shown in Figures 3.4a and 3.4b.
- 6 The standard TRAFFIC SIGNAL FACE S1 is used when traffic is permitted to proceed in any direction that is allowed at the junction. The signal face is also used at signalised pedestrian and pedal cyclist crossings, as well as for the control of two-way traffic on a single lane. The signal face may NOT be used on the same approach as signal faces S2, S3, S4, S5, S6 and S7 (because of the conflicting meanings of the green light signals).
- 7 Standard TRAFFIC SIGNAL FACES S1B and S1T are only applicable to vehicles allowed in exclusive bus and tram lanes respectively. The faces may NOT be used to control buses or trams travelling in non-exclusive lanes.
- 8 Standard TRAFFIC SIGNAL FACES S1A, S1AR and S1AL are used ONLY in the **Alternative System**. The faces are used to signal protected turning phases, and may only be used if the turning movement indicated by the direction of the arrows is unopposed by any conflicting movements.
- 9 Standard TRAFFIC SIGNAL FACES S1R and S1L are used to signal protected-only turning phases. The flashing green signals indicate that the turning movement is unopposed by any conflicting movements during the turning phase. During other phases, turning is prohibited by the red light signal. The use of the signals faces is subject to the following conditions:
- The signal faces may be used without TRAFFIC SIGNAL ARROW SIGNS ST2 and ST3 on approaches to junctions serving only one turning movement or on signalised slipways that are separated from other turning movements by a constructed island.
  - The signal faces must be used in combination with TRAFFIC SIGNAL ARROW SIGNS ST2 and ST3 on approaches to junctions from which more than one direction of movement is allowed. Examples of the combined use of the traffic signal faces and arrow signs are shown in Figures 3.4a and 3.4b.
  - The signal faces may only be used when the conditions for the use of red, yellow and green light signals given in Sections 3.5.2 to 3.5.4 of this chapter are met.
- 10 Standard TRAFFIC SIGNAL FACES S2, S3, S4, S5, S6 and S7 may be used where traffic is permitted to proceed only in particular directions. The use of the signal faces is subject to the following conditions:
- The signal faces should preferably only be used to indicate the direction of ONE-WAY roads or streets.
  - Traffic signal faces S2, S6 and S7 may ONLY be used if there are no vehicular movements from the opposite direction conflicting with the right-turn movement.
  - The signal faces shall NOT be used on the same approach as signal face S1 (because of the conflicting meanings of the green light signals).
  - The green arrow light signals on signal faces S5, S6 and S7 shall be indicated concurrently.
- 11 Standard TRAFFIC SIGNAL FACES S8, S8B, S8T, S9, S9B and S9T may be applied in a similar way than traffic signal faces S1, S1B and S1T, except that provision is made for signalling of a protected/permitted turning phase. During the turning phase, the movement is protected and unopposed by any conflicting traffic movement. During other phases of the signal, the turning movement is permitted (e.g. by means of gap acceptance). The use of the signal faces is subject to the following conditions:
- The signal faces may only be used when the conditions for the use of red, yellow and green light signals given in Sections 3.5.2 to 3.5.4 of this chapter are met.
  - The traffic signal faces can also be provided as two separate but adjacent traffic signal faces (e.g. faces S1 and S10R instead of face S8).
- 12 Standard TRAFFIC SIGNAL FACES S10R, S10L, S10B and S10T may be used to signal protected/permitted right-turn or left-turn phases. The use of the signal faces is subject to the following conditions:
- The light signals shall only be displayed during the protected turning phase and shall NOT be displayed at any other time.
  - The signal faces may only be used when the conditions for the use of yellow and green signal faces given in Sections 3.5.2 to 3.5.4 of this chapter are met.
  - The signal faces can be used as stand-alone signal faces or in combination with other signal faces. The stand-alone configuration, however, is not recommended (since no red light signal is available in these faces).

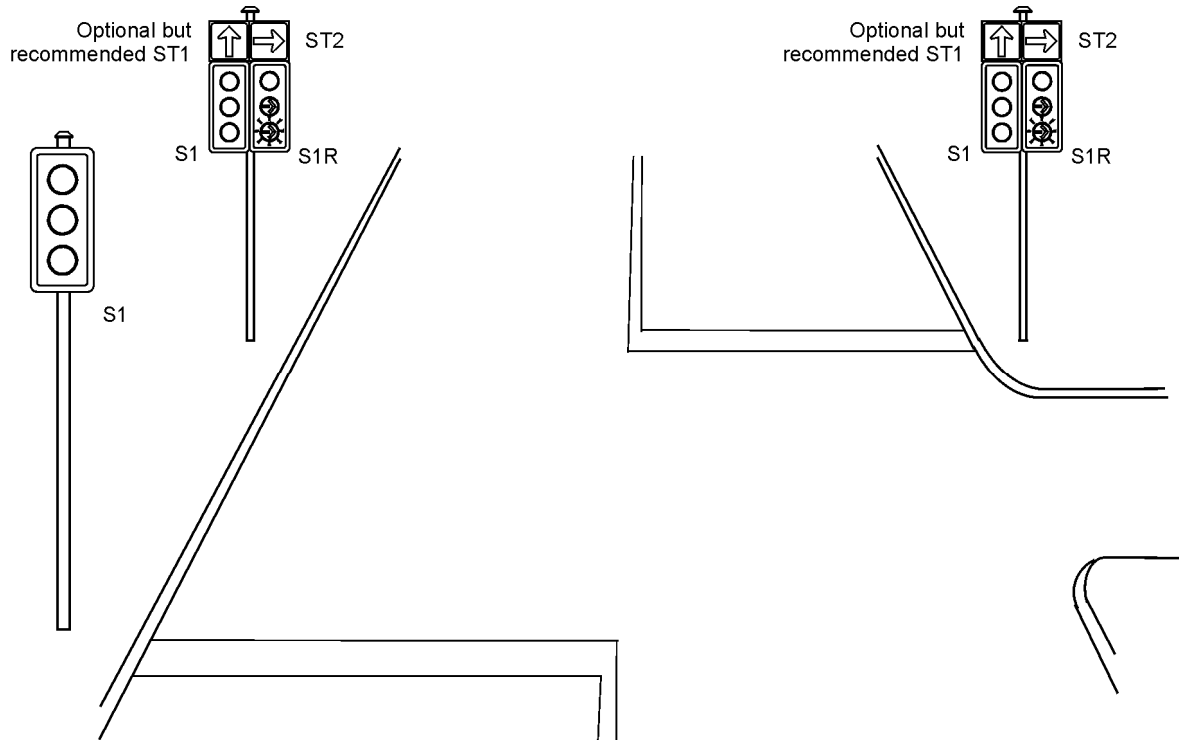

Figure 3.4a: Signalling for protected-only right turn at a T-junction

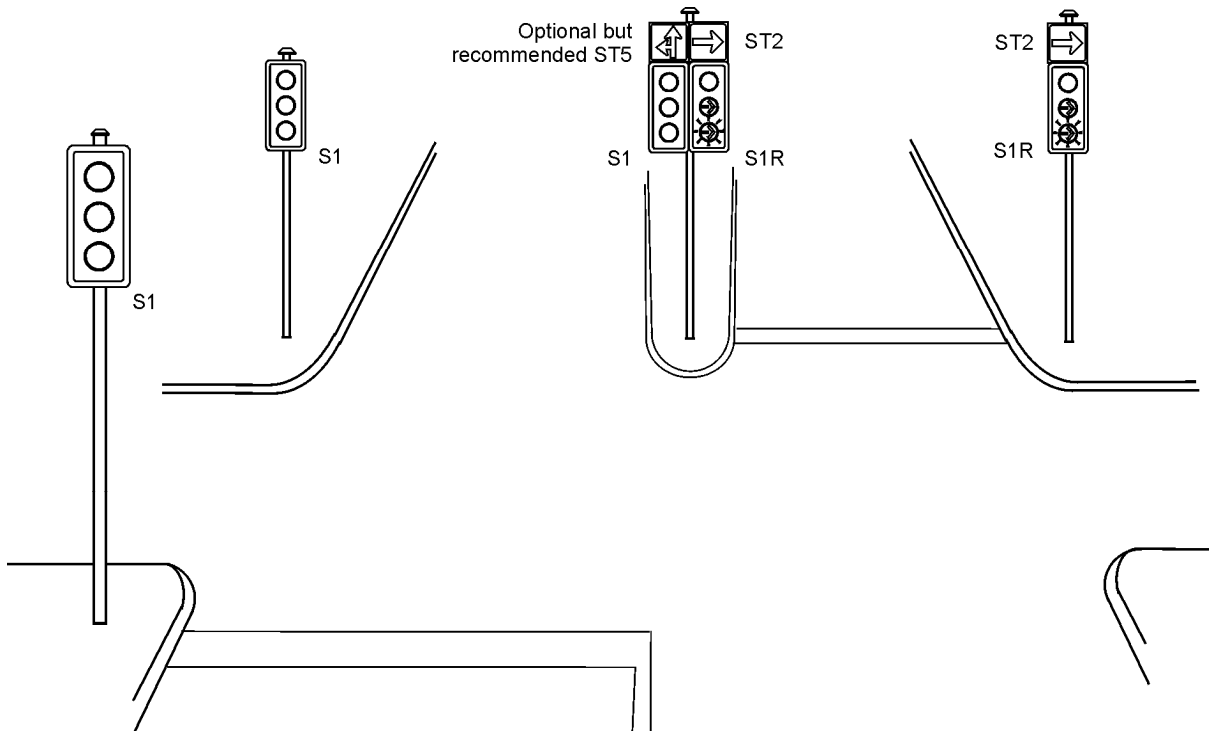

Figure 3.4b: Signalling for protected-only right turn at a 4-way junction (road divided by a median)

### 3.9 NUMBER AND LOCATION OF TRAFFIC SIGNAL FACES

#### 3.9.1 General requirements

- 1 Traffic signal faces for use at junctions and pedestrian or pedal cyclist crossings are classified as follows:
  - (a) **Principal traffic signal faces** are faces provided to meet the minimum legal requirements of the National Road Traffic Regulations.
  - (b) **Supplementary traffic signal faces** are additional traffic signal faces, not being principal traffic signal faces, provided to meet requirements in respect of visibility and conspicuity or improved traffic operations.
- 2 According to the National Road Traffic Regulations, the following PRINCIPAL traffic signal faces SHALL be provided at a signalised junction, signalised slipway or signalised pedestrian or pedal cyclist crossing for the control of vehicular traffic for each direction from which vehicular traffic may approach the junction, slipway or crossing (*these requirements shall not necessarily apply to traffic signals used at other locations*):
  - (a) FAR-SIDE PRINCIPAL SIGNAL FACES. *“At least two traffic signal faces shall be provided on the far side of the stop line RTM1 at locations:*
    - (i) *that are NOT on the near side of a junction or slipway;*
    - (ii) *that are not less than 6 metres (but preferably not less than 10 metres) from the stop line RTM1;*
    - (iii) *such that the two traffic signal faces shall not be less than 3 metres and not more than 20 metres apart; Provided that where it is unavoidable that the traffic signals are more than 20 metres apart, additional PRINCIPAL traffic signals shall be provided in such a manner that no traffic signals are more than 20 metres apart (signals should preferably not be more than 16 metres apart);*
    - (iv) *at a signalised junction, but not a pedestrian or pedal cyclist crossing, where a straight-through movement is permitted from an approach to the junction, and where the roadway continues straight through the junction, a traffic signal face for the control of straight-through movements shall be provided subject to the requirements of subparagraphs a) (i) to (iii), on either side of the roadway on the far side of the junction; Provided that when the roadway is divided at the junction by a constructed median island of adequate width to accommodate a signal, the right-hand traffic signal face shall be situated on the median island;”*
  - (b) NEAR-SIDE PRINCIPAL SIGNAL FACES. *“At a signalised junction or slipway, but not a pedestrian or pedal cyclist crossing, at least one signal face containing a red light signal shall be provided on the near side of the junction or slipway, on the left- or right-hand side of the roadway at a position not further than 3 metres from the prolongation of the stop line RTM1”.* Although not prescribed, the near-side signal face is also recommended at pedestrian and pedal cyclist crossings.
  - (c) PRINCIPAL SIGNAL FACES FOR TURNING PHASES. *“When a separate left- or right-turn signal is required, at least two traffic signal faces that incorporate a flashing green arrow light signal, flashing green bus light signal or a flashing green tram light signal, shall be provided, one on the far side of the stop line RTM1 subject to subparagraphs a) (i) and (ii), and the other on the far or near side;”*
- 3 According to the National Road Traffic Regulations *“additional traffic signal faces may be provided at the junction or crossing at any suitable location”*, even if the minimum requirements for principal traffic signal faces have been met. Supplementary signal faces must be provided where the minimum visibility requirements cannot be achieved by means of the principal faces alone.
- 4 **With the exception of Traffic Signals S16 to S19, the position of a signal face on an approach, including an overhead mounted signal face, in relation to any lane on the approach, is generally not significant in the interpretation of the light signal by the road user (although positions of traffic signals may be prescribed).**
- 5 A number of examples of traffic signal layouts showing the minimum required principal traffic signal faces are given in Appendix B of this manual.

#### 3.9.2 Two-way traffic on a single lane

- 1 Traffic signals may be installed to successively give right of way to traffic from opposite directions on a single traffic lane, such as a narrow bridge and tunnel, or at roadworks when only one lane of the road is open.
- 2 At least two traffic signal faces of type S1 shall be provided on a two-way single lane road, one on each side of the road, at a position not less than 6 m (but preferably not less than 10 m) beyond the stop line RTM1. However, where the traffic signal is manually operated (such as at roadworks), only one such signal face may be provided.
- 3 The stop line should be suitably located on the wider part of the road so that opposing traffic can pass any vehicles waiting at the stop line.

- 4 An all-red interval of sufficient duration is necessary that would allow slow moving traffic to clear the single lane section before the onset of the opposing green. For fixed time operation, this may be established based on the 15<sup>th</sup> percentile free-flow speed on the lane (judgement may be required to establish whether this would be adequate). When vehicle-actuated control is provided, the all-red period can be determined by the controller from vehicle detector inputs.
- 5 When sufficient sight distance is provided, the vehicular red light signal may be followed by a flashing red light signal to indicate that drivers can proceed if no vehicles are present in the opposite direction on the single lane section.

### 3.9.3 Left- and right-turn signal phases

- 1 Turning movements at traffic signals can be permitted, prohibited or protected. The different modes of operation are as follows:
  - (a) *Permitted-only mode* in which a turning movement is permitted but no exclusive turning phase is provided.
  - (b) *Protected/permitted mode* in which an exclusive protected turning phase is provided, but the turning movement is also permitted during the main phase.
  - (c) *Protected-only mode* in which vehicles are only allowed to turn during a protected phase.
  - (d) *Prohibited mode* in which no turning movement is allowed.
- 2 Protected signal phases can be provided as follows:
  - (a) *Protected/Permitted mode* – traffic signal faces S10R, S10L, S10B or S10T used singly or in combination with another suitable signal face that contains a red light signal (preferably not singly). Signal faces S8, S8B, S8T, S9, S9B and S9T can also be used for this purpose.
  - (b) *Protected-only mode on an approach other than a signalised slipway* – traffic signal faces S1R and S1L with TRAFFIC SIGNAL ARROW SIGNS ST2 and ST3 respectively.
  - (c) *Protected-only mode on a signalised slipway* – traffic signal faces S1R and S1L without TRAFFIC SIGNAL ARROW SIGNS ST2 or ST3.
- 3 When one of the traffic signal faces S1R and S1L is used to control a turning movement, the straight-through and other turning movement must be controlled using another suitable traffic signal face. When used on an approach other than a signalised slipway, separate lanes must be provided for the turning movements controlled by the S1R and S1L signal faces. Such lanes should preferably be separated from other lanes by a WM2 CONTINUITY LINE, a RM5 PAINTED ISLAND or a constructed island.
- 4 Figures 3.5a and 3.5b illustrate a number of traffic signal operating sequences for right-turn phases. Details are shown for leading as well as lagging right-turn phases, for situations where the phases start or end with the main phase or where they run before or after the main phase. Figure 3.5a shows the details for *protected/permitted* right-turn phases and Figure 3.5b the details for *protected-only* phases.

## 3.10 SIGNALS ON HIGH-SPEED ROADS

- 1 The speed limit on any approach to a signalised junction or pedestrian or pedal cyclist crossing shall NOT exceed 80 km/h.
- 2 At traffic signals where the speed limit is 70 km/h or higher, the following measures can be considered to improve the visibility of the signals:
  - (a) high intensity traffic light signals; or
  - (b) overhead mounted traffic signal faces;
- 3 At traffic signals where accidents occur due to high speed, or transgression of posted speed limits occurs, consideration may be given to the measures given above as well as the following corrective measures:
  - (a) law enforcement of the speed limit;
  - (b) high visibility warning signs in advance of the signals;
  - (c) skid resistant road surface, particularly on downhill approaches to the signals;
  - (d) speed calming measures (e.g. rumble strips), but only if they are not distracting to drivers (such measures should preferably be introduced in advance of the traffic signal and not at the traffic signal); or
  - (e) converting the traffic signal to a traffic circle.
- 4 Speed discrimination equipment may be used to continually vary the intergreen period depending on vehicle approach speeds. The cost of the equipment may, however, mitigate against the use of such equipment. Where operating speeds are higher than the speed limit, it would be advisable to enforce the speed limit.

## 3.11 VISIBILITY REQUIREMENTS

- 1 Under normal atmospheric conditions, traffic signal faces should be clearly visible and recognisable on approaches to a signal. Where the principal signal faces alone cannot provide the required visibility, additional traffic signal faces must be provided to supplement the principal signal faces.
- 2 The overriding objective in deciding the number and location of supplementary traffic signal faces is that light signals should be clearly visible to the approaching vehicles for which they are intended, taking into account:
  - (a) the position of the vehicle on the approach;
  - (b) the alignment of the approach;
  - (c) obstructions to visibility (including other vehicles that may be queued on an approach);
  - (d) distracting lights and signs; and
  - (e) required sight distances.
- 3 Street lights, illuminated signs and distracting advertising signs close to, or behind traffic signals may be confusing and distracting to drivers. Such distracting features should not be permitted.

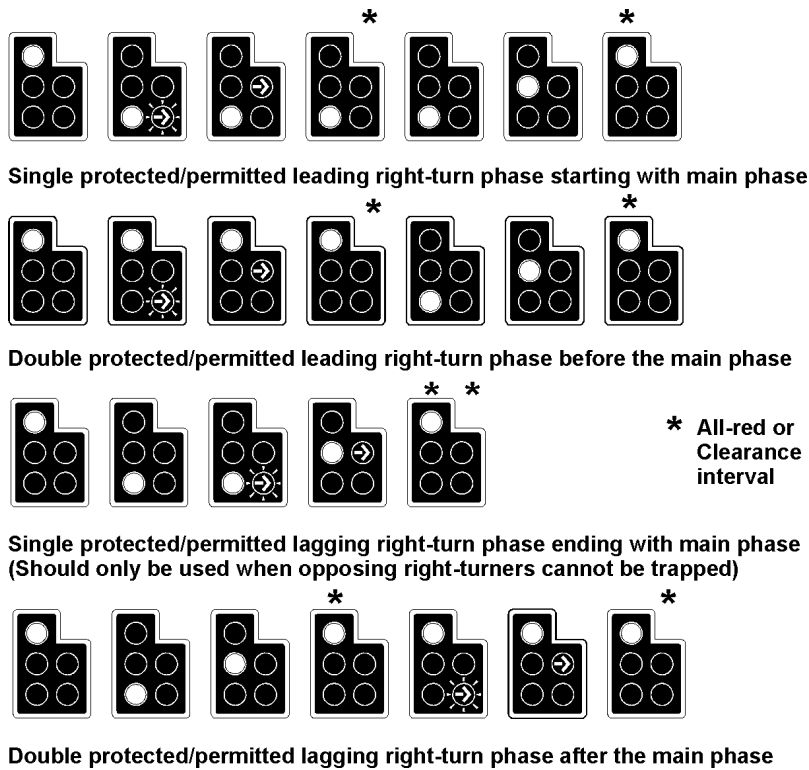

Figure 3.5a: Traffic signal sequence for protected/permitted right-turn phases using a S8 signal face

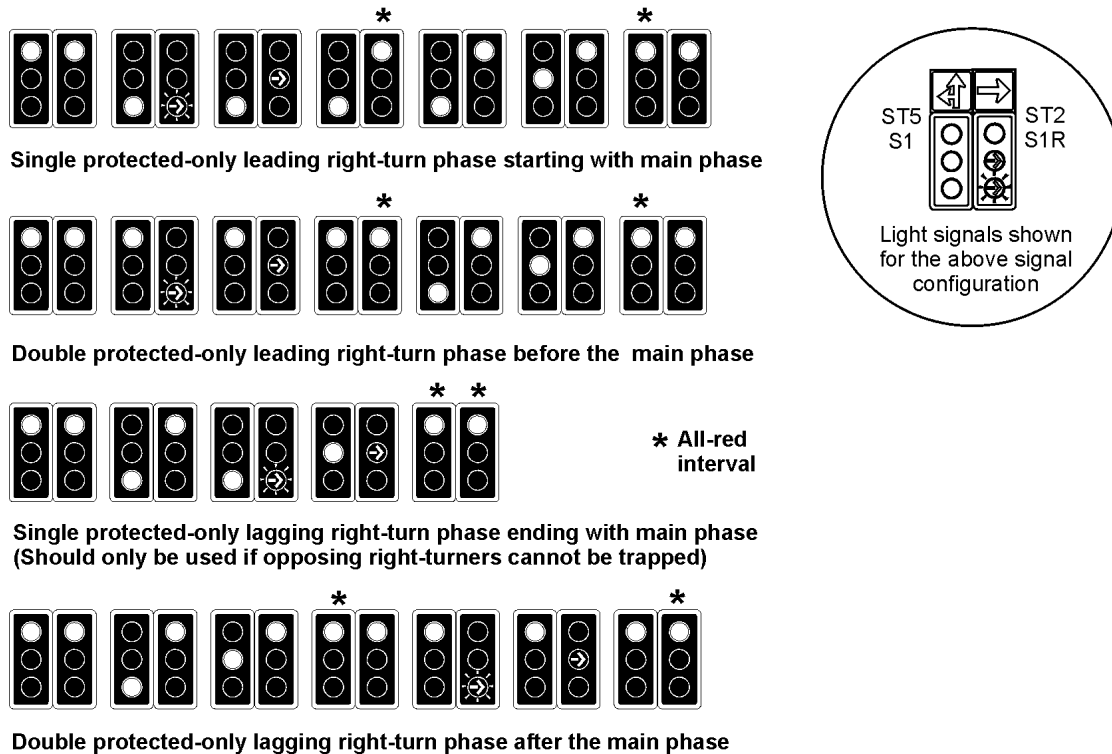

Figure 3.5b: Traffic signal sequence for protected-only right-turn phases using the S1 and S1R signal faces in conjunction with ST5 and ST2 traffic signal arrow signs.

- 4 Signal faces should be visible over the minimum distances described below. In each case, all light signals in a face must be visible from a reference point 1,05 m above the centre line of each lane of traffic for which the signal face is intended.
- 5 At least two traffic signal faces - principal or supplementary - should be visible at any one time over the minimum sight distances from the stop line given in Table 3.1. The sight distances given in the table allow for driver recognition, reaction and stopping times from the speed limit or posted advisory speed.
  - (a) Minimum and preferable sight distances are given for urban roads. The minimum sight distances given for rural roads are the preferred distances for urban roads. The minimum sight distances are based on a shorter reaction time, and should only be used at junctions where drivers would expect a traffic signal. The longer sight distances should be used when traffic signals are not expected and a longer reaction time is required to respond to the signals.
  - (b) The sight distances also vary according to the approach grade to a junction or crossing. Note that sight distances for speeds lower than 60 km/h should be permitted only in circumstances where the geometry of the approach ensures that vehicles reduce speed, and an appropriate advisory speed and warning sign is posted.
- 6 At least two traffic signal faces on the far side of the stop line should be visible from a distance of 50 m or more, up to the stop line.
- 7 At least one traffic signal face should lie within the average driver's "cone of vision" as shown in Figure 3.6. The cone of vision is measured from the stop line position, 20 degrees on either side of the continuation of the centre line of each approach lane.
- 8 At least one traffic signal face on the far side should be visible for right-turning vehicles waiting inside the junction to turn right. This traffic signal should preferably be located on the far right-hand corner of the junction.
- 9 Additional supplementary signal faces may (and preferably should) be provided to ensure consistency and uniformity along a road or street. For instance, if an overhead mounted signal face is provided at one location, then such signals should be provided at other junctions and pedestrian and pedal cyclist crossings on the road or street (but only while roadway and other characteristics remain the same along the road or street and when signals are spaced at distances closer than 1 km apart).
- 10 The optical axis of each light signal should be positioned and aligned so that it is at the greatest effectiveness to the approaching traffic for which it is intended. The optical axis of each light signal should be aligned on the reference point in the centre of the approach lane or lanes midway over the distance that it is intended to control.
- 11 CARE SHOULD BE TAKEN TO ENSURE THAT NO TRAFFIC SIGNAL FACE INTENDED FOR TRAFFIC ON ONE APPROACH IS ALIGNED SO THAT IT COULD BE WRONGLY TAKEN TO APPLY TO ANOTHER APPROACH AT THE SAME JUNCTION.

## 3.12 MOUNTING OF VEHICULAR TRAFFIC SIGNALS

### 3.12.1 General

- 1 Traffic signal faces may be mounted on one of the following supports:
  - (a) standard post;
  - (b) extended (longer) post; or
  - (c) overhead cantilever or gantry;
 Supporting traffic signal faces by means of catenary wires or cables, is NOT allowed.
- 2 A lateral clearance of at least 0,5 m should generally be provided from the edge of a roadway and any post or any part of a signal face, including the backboard. If there is a significant tipping of vehicles to one side due to camber or crossfall on the road, or where vehicles tend to cut corners, it is preferable to increase the clearance to 1,0 m or more.
- 3 On medians, where insistence on the 0,5 m lateral clearance would mean that signal faces cannot be provided on the median, the lateral clearance can be reduced to an absolute minimum of 0,1 m, but only if the camber or crossfall of the roadway falls away from the median.

### 3.12.2 Post-mounted traffic signals

- 1 Principal traffic signal faces should preferably be post-mounted at the side of the road. Supplementary traffic signal faces may be either post-mounted or mounted above the road surface on a gantry or cantilever.
- 2 Traffic signal faces on the left-hand side of the road, should generally be located not more than 2 m to the left of the continuation of the left-hand edge of the approach roadway, measured parallel to the road centre line and excluding any approach splay.
- 3 Traffic signal faces that are mounted on posts at the side of the road, should be not less than 2,3 m and not more than 3 m above the level of a point on the road surface nearest to the post, measured to the centre of the lowest (green) signal aspect, as shown in Figure 3.7. A minimum clearance of not less than 2,1 m above the sidewalk should also be provided.
- 4 Where it is necessary to achieve the minimum visibility requirements (e.g. on a vertical curve), supplementary traffic signal faces may be mounted on posts at the side of the road at a height exceeding 3 m. These supplementary traffic signal faces may be mounted on the same post, provided that the two traffic signal faces shall be not less than 1 m apart, measured from the centres of the two nearest light signals on the two signal faces, as shown in Figure 3.8. There is no maximum limit, but line-of-sight and stability factors should be taken into consideration and a practical limit would be 5 m (between centres of two closest light signals).

**Table 3.1: RECOMMENDED SIGHT DISTANCES FOR TRAFFIC SIGNALS**

| Speed limit or advisory speed (km/h) | Minimum for urban conditions (where signals are expected) | Preferable for urban conditions and minimum for rural conditions | Adjustments for grades  |      |                             |      |
|--------------------------------------|---|--|-------------------------|------|-----------------------------|------|
|                                      |   |  | Add for a downgrade of: |      | Subtract for an upgrade of: |      |
|                                      |   |  | -5%                     | -10% | +5%                         | +10% |
| 40 km/h (*)                          | 55 m  | 130 m  | 0 m                     | 5 m  | 0 m                         | 5 m  |
| 50 km/h (*)                          | 80 m  | 160 m  | 5 m                     | 10 m | 5 m                         | 5 m  |
| 60 km/h                              | 110 m   | 190 m  | 10 m                    | 20 m | 5 m                         | 10 m |
| 70 km/h                              | 140 m   | 215 m  | 10 m                    | 25 m | 10 m                        | 15 m |
| 80 km/h                              | 170 m   | 240 m  | 15 m                    | 35 m | 10 m                        | 20 m |
| 90 km/h                              | 210 m   | 270 m  | 20 m                    | 45 m | 15 m                        | 25 m |

(\*) To be used only in conjunction with an advisory speed sign, e.g. at a horizontal curve

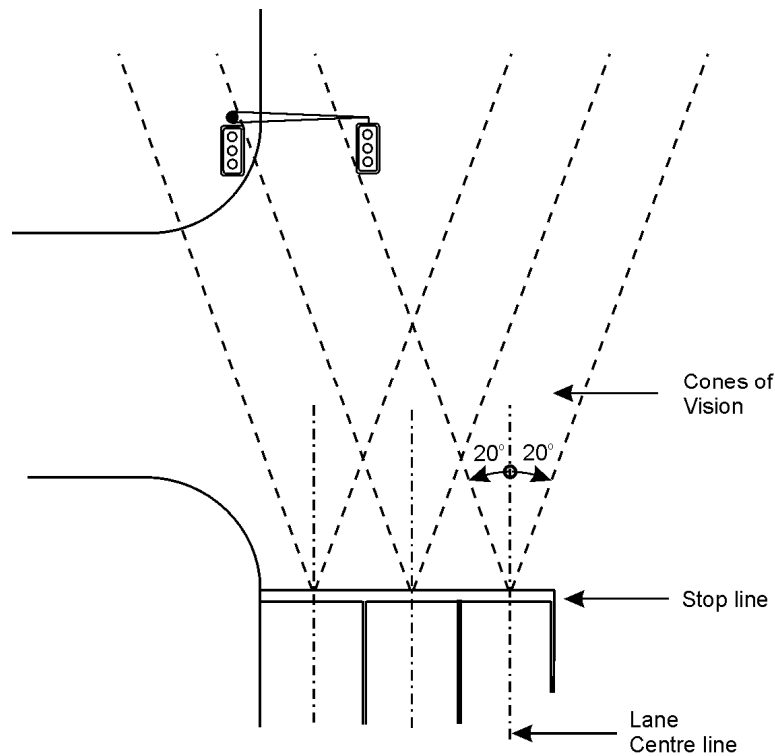

Figure 3.6: Cone of vision in horizontal plane

### 3.12.3 Overhead traffic signals

- 1 Overhead mounting may be used for any principal or supplementary traffic signal face (principal signal faces should preferably be post-mounted). Overhead mounting will also be required when it is not possible to comply with the requirement that principal signal faces may not be further than 20 m apart (preferably not further than 16 m apart).
- 2 Consideration should be given to providing overhead mounted signal faces as supplementary signal faces at junctions or crossings where accidents occur due to high speed, or to ensure consistency and uniformity along a road or street.
- 3 Any traffic signal face that is mounted on a gantry or cantilever above the roadway SHALL have a minimum clearance above the road of not less than 5,2 m. The height to the lowest light signal should not exceed 6,2 m on a level road, as shown in Figure 3.9.
- 4 The vertical part of the gantry or cantilever structure may be used to mount a signal face at the side of the road.
- 5 The position of the traffic signal face mounted on a gantry or cantilever, relative to the traffic lane over which it is located, is NOT of significance in the meaning of the signal. The light signals displayed by such signal face apply to the approach and NOT just the lane over which it is located (does not apply to signals S16 to S19). **The cantilever should, however, preferably be located on the left-hand side of the road.**
- 6 The cantilever may be of any horizontal reach, although in practice a reach that exceeds 5 m will present stability problems. Alternatively, an overhead gantry can be used when a longer reach is required.

### 3.13 TRAFFIC SIGNAL LAYOUT PLANS

- 1 Traffic signal layout plans are used to show the numbers, types and location of traffic signal faces, as well as other elements of the traffic signal.
- 2 The National Road Traffic Regulations require that the layout plans SHALL be approved by a **"responsible registered professional engineer or registered professional technologist (engineering) of the road authority concerned"**, and that the signal plan shall be kept by the road authority in control of the traffic signal."
- 3 According to the regulations, the plan must at least contain the following information:
  - (a) scaled drawing of the layout of the junction, indicating lane markings and road layout;
  - (b) number, type and location of traffic signal faces;
  - (c) number, type and location of pedestrian and pedal cyclist facilities, including pedestrian push buttons; and
  - (d) name, signature and registration number of the engineer or technologist who approved the signal, and date of signature.
- 4 An example of a traffic signal plan is given in Figure 3.10. The example shows a scaled drawing of the layout of the junction, lane markings, traffic signal faces, vehicle detection loops, pedestrian facilities and other data as required above. The plan also shows the signal groups that display exactly the same sequence of light signals at the same time (more information on signal groups is given in Chapter 6 of this manual).
- 5 The example traffic signal plan in Figure 3.10 utilises text to indicate types of traffic signal faces. This method is used throughout this manual. Symbols may also be used to indicate traffic signal faces as shown in Figure 3.11. The symbols used in this figure are pictorial and can be readily interpreted without reference to a legend.



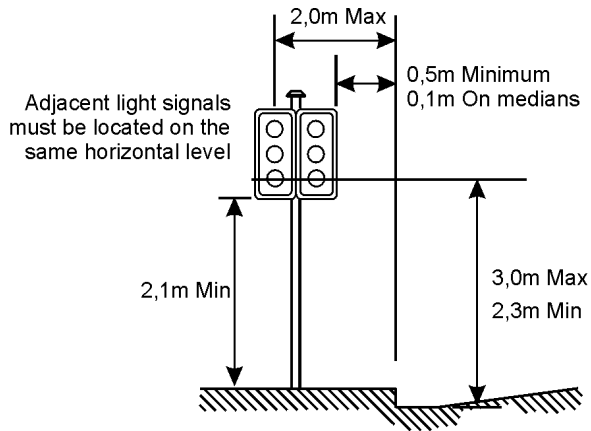

Figure 3.7: Standard post mounting

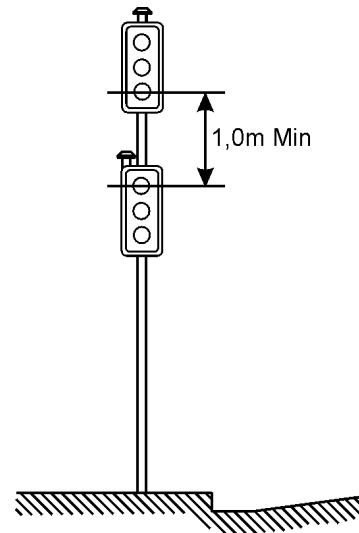

Figure 3.8: Extended post mounting

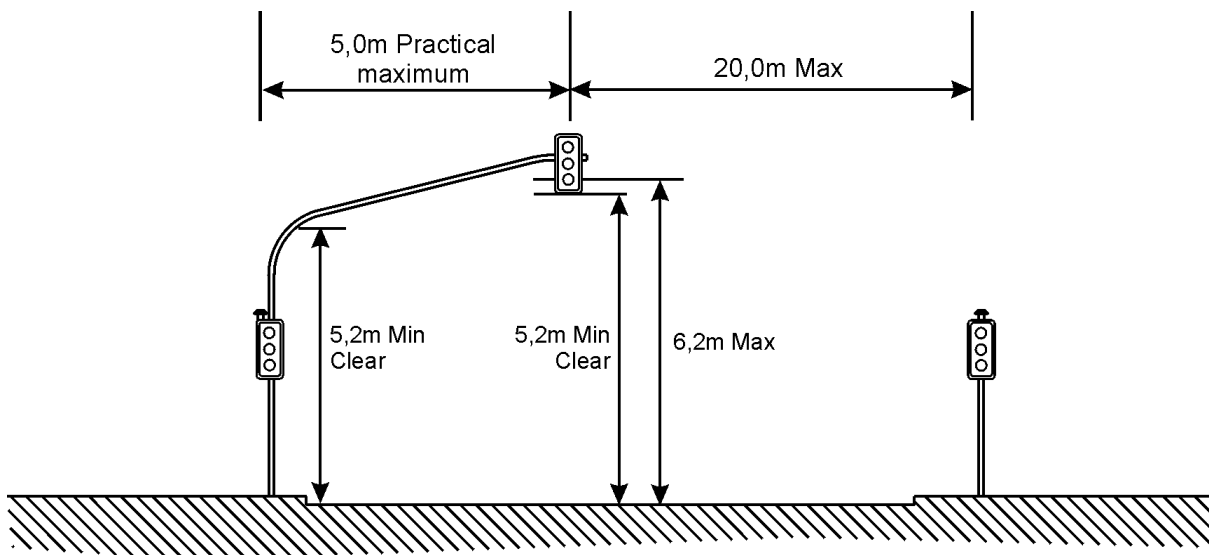

Figure 3.9: Overhead (cantilever) mounting of traffic signal faces

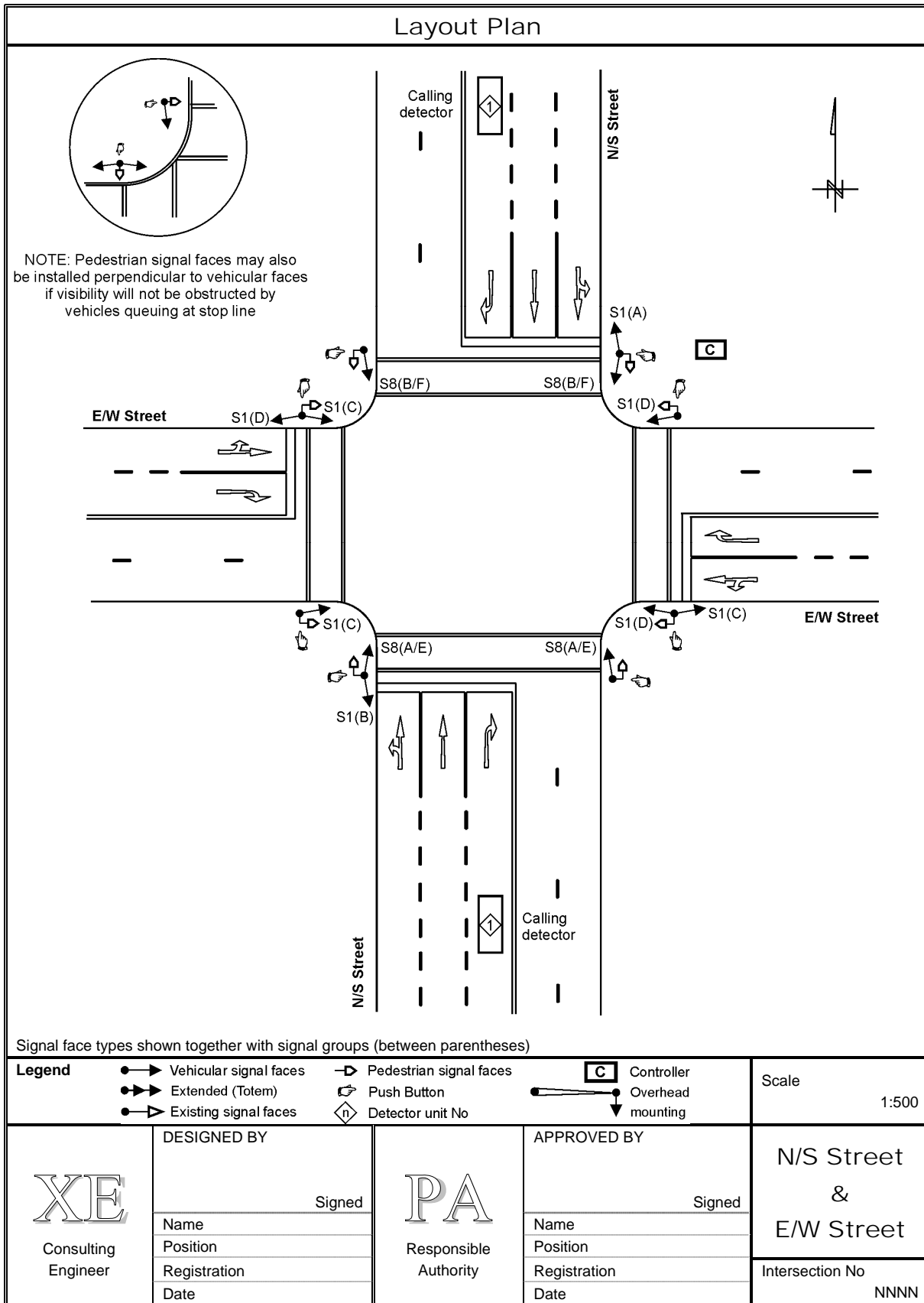

Figure 3.10: Example traffic signal layout plan

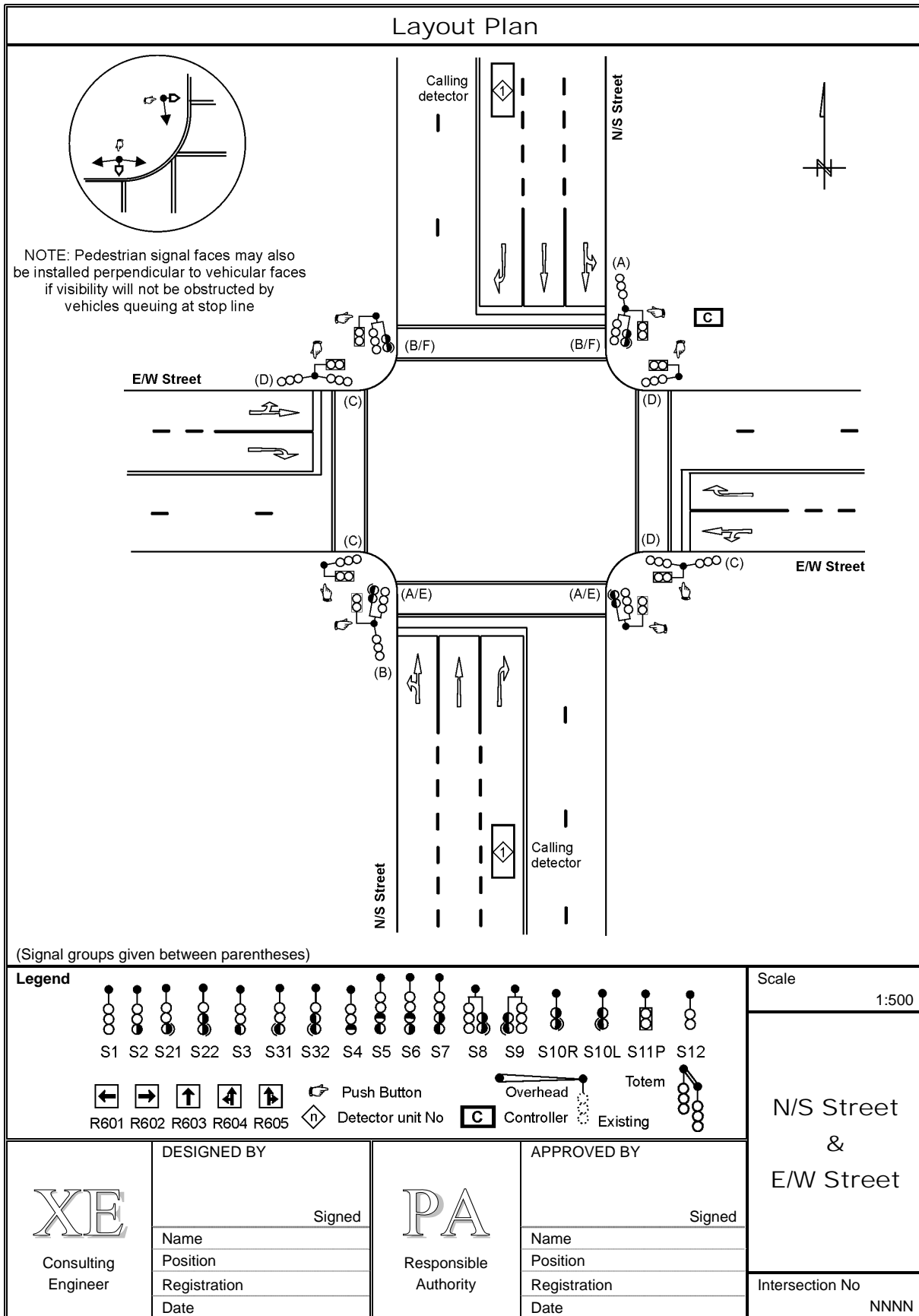

Figure 3.11: Alternative traffic signal layout plan using graphic symbols for signal faces



## CHAPTER 4: PEDESTRIAN AND PEDAL CYCLIST SIGNALS

### 4.1 INTRODUCTION

- 1 Pedestrian and pedal cyclist traffic is subject to control by any traffic signal that is intended for vehicular traffic. Separate signals, however, can be provided for the control of pedestrians and pedal cyclists.
- 2 Pedestrian and pedal cyclist signals SHALL be operated only in conjunction with vehicular traffic signals. They will normally be provided where a significant number of pedestrians or pedal cyclists experience difficulty and/or delay in crossing a road at certain times during the day. Situations in which pedestrian or pedal cyclist signals may be used are:
  - (a) at signalised road junctions; and
  - (b) at signalised mid-block pedestrian and pedal cyclist crossings.
- 3 Warrants for the provision of signals at pedestrian and pedal cyclist mid-block crossings are given in Chapter 2 of this manual (Volume 3).
- 4 **The general provisions for vehicular traffic signals given in Chapter 3 of this manual (Volume 3) shall also apply to pedestrian and pedal cyclist signals and to vehicular traffic signals used in conjunction with such signals, except where otherwise noted in this chapter.**
- 5 Where pedestrian signals are not provided at a junction, vehicular traffic shall yield right of way to pedestrians lawfully in the junction. Pedal cyclists, however, do not have the same right of way and are treated similar to vehicular traffic when pedal cyclist signals are not provided.

### 4.2 PEDESTRIAN AND PEDAL CYCLIST SIGNALS

- 1 Pedestrian light signals shall comprise:
  - (a) a STEADY GREEN MAN LIGHT SIGNAL, followed by:
  - (b) a FLASHING RED MAN LIGHT SIGNAL, followed by:
  - (c) a STEADY RED MAN LIGHT SIGNAL.
- 2 Pedal cyclist signal installations shall comprise:
  - (a) a STEADY GREEN PEDAL CYCLIST LIGHT SIGNAL, followed by:
  - (b) a FLASHING RED PEDAL CYCLIST LIGHT SIGNAL, followed by:
  - (c) a STEADY RED PEDAL CYCLIST LIGHT SIGNAL.
- 3 Pedestrian and pedal cyclist light signals shall have the significance assigned to them in the National Road Traffic Regulations. The meanings assigned to the different light signals below are quoted directly from the regulations.

- 4 A STEADY GREEN MAN LIGHT SIGNAL indicates ***“to a pedestrian that he or she may cross the roadway within the pedestrian crossing markings RTM3 or RTM4 as appropriate, and that the driver of a vehicle shall yield right of way to a pedestrian crossing such roadway”***.
- 5 A STEADY GREEN PEDAL CYCLIST LIGHT SIGNAL indicates ***“to a pedal cyclist that he or she may cross the roadway within the pedal cyclist crossing, and that the driver of a vehicle shall yield right of way to a pedal cyclist crossing such roadway”***.
- 6 A FLASHING RED MAN LIGHT SIGNAL indicates ***“to a pedestrian (a) who has not yet commenced crossing the roadway that he or she shall not cross the roadway until the steady green man light signal is displayed, or (b) who is within a pedestrian crossing that the steady red man light signal will follow shortly”***.
- 7 A FLASHING RED PEDAL CYCLIST LIGHT SIGNAL indicates ***“to a pedal cyclist (a) who has not yet commenced crossing the roadway that he or she shall not cross the roadway until the steady green pedal cyclist light signal is displayed, or (b) who is within a crossing that the steady red pedal cyclist light signal will follow shortly”***.
- 8 A STEADY RED MAN LIGHT SIGNAL indicates ***“to a pedestrian that he or she shall not cross the roadway until the steady green man light signal is displayed”***.
- 9 A STEADY RED PEDAL CYCLIST LIGHT SIGNAL indicates ***“to a pedal cyclist that he or she shall not cross the roadway until the steady green pedal cyclist light signal is displayed”***.
- 10 A GREEN MAN or PEDAL CYCLIST LIGHT SIGNAL shall not be displayed at the same time as a FLASHING or STEADY RED MAN or PEDAL CYCLIST LIGHT SIGNAL on the same crossing.
- 11 A pedestrian signal face shall comprise two light signals, one depicting a red standing man and the other depicting a green walking man. The standard signal face Type S11P shall be used. The red man shall be located in line directly above the green man signal aspect.
- 12 A pedal cyclist signal shall comprise two light signals, displaying a green and red bicycle symbol respectively when illuminated. The standard pedal cyclist signal face Type S11C shall be used. The red pedal cyclist shall be located directly in line above the green pedal cyclist aspect.

### 4.3 OPERATION OF PEDESTRIAN AND PEDAL CYCLIST SIGNALS

- 1 The function of the steady GREEN MAN and GREEN PEDAL CYCLIST LIGHT SIGNAL is to provide a limited initial "step off" or "launching" interval for pedestrians and pedal cyclists. It SHALL always be followed immediately by a FLASHING RED MAN or PEDAL CYCLIST LIGHT SIGNAL.
- 2 The STEADY GREEN MAN or PEDAL CYCLIST LIGHT SIGNAL shall be displayed for an interval appropriate for the particular traffic conditions and shall be not less than a minimum of 4 seconds. A longer interval of 5 to 7 seconds, however, is more desirable. Longer intervals may be required when pedestrian volumes are high, but volumes requiring an interval longer than 7 seconds do not occur often. Where vehicular capacity is important, the green interval should not be made longer than necessary. However, where capacity is not important, the maximum possible pedestrian green may be given.
- 3 Sufficient time must be provided after the green man or pedal cyclist light signal for a pedestrian to walk or pedal cyclist to push his or her bicycle across the roadway to the other side of the road, or up to the median island where such median is provided. Where the median is set back from the pedestrian crossing, sufficient time must be provided to allow crossing of the junction in one stage.
- 4 A design walking speed of 1,2 m/s should be used for calculating the pedestrian or pedal cyclist **clearance time** under normal operating conditions. A slower speed of 1,0 m/s may be used for elderly or infirm pedestrians. The pedestrian or pedal cyclist must be able to clear the roadway by the time the parallel **vehicular intergreen** ends (end of the **all-red** interval).
- 5 The FLASHING MAN or PEDAL CYCLIST LIGHT SIGNAL should not be displayed for a period longer than the duration of the pedestrian or pedal cyclist **clearance time**. The flashing signal can, however, be displayed for a shorter period if a STEADY RED MAN or PEDAL CYCLIST LIGHT SIGNAL is displayed for the remainder of the clearance time. The flashing signal should not be displayed for a period shorter than the **minimum** of the following two values:
  - (a) 75% of the clearance time; or
  - (b) the clearance time less the parallel vehicular intergreen period.
- 6 At road junctions, the pedestrian or pedal cyclist phase may run concurrently with a parallel vehicular phase. **The vehicle phase, however, SHALL not include any exclusive turning phase in conflict with the pedestrian or pedal cyclist green phase.**
- 7 The green man (and pedal cyclist) signal normally starts at the same time as the vehicular green. The vehicular green light signal, however, may be delayed to allow pedestrians to enter the roadway ahead of vehicles. Care should be taken in using delays longer than 3 seconds as such delays can lead to undesirable behaviour. Such behaviour may include illegal turning manoeuvres by drivers and pedestrians (or pedal cyclists) utilising the delay to cross the junction in the wrong direction.
- 8 At a **mid-block pedestrian or pedal cyclist crossing**, other than where a "Pelican" phase has been provided, a vehicular red light signal SHALL be displayed for at least the full duration of the green and flashing red man or pedal cyclist intervals. It may also be necessary to introduce an "all-red" interval.
- 9 At a mid-block pedestrian or pedal cyclist crossing, a "Pelican" phase may be provided to indicate to drivers of vehicles that pedestrians may be clearing the road and have right of way. During the "Pelican" phase, vehicular FLASHING RED DISC LIGHT SIGNALS are displayed at the same time as the FLASHING RED MAN or PEDAL CYCLIST LIGHT SIGNAL. **Pedestrians may not enter the crossing on the flashing red man, and the duration of this interval should therefore NOT exceed the time required by pedestrians to clear the crossing.**
- 10 Pedestrian phases should generally be demand dependent (using push buttons), even when used at fixed time signals. This is because the vehicular green interval is often made longer to meet pedestrian requirements. When no demand is registered for a signal phase, a shorter vehicular green phase can be provided which could reduce overall vehicular delay.
- 11 When vehicular signals are in flashing mode, pedestrian and pedal cyclist signals must be switched off, giving no pedestrian or pedal cyclist indications (except when the signal is operating in pelican mode).

### 4.4 PROVISION OF PEDESTRIAN SIGNALS AT JUNCTIONS

- 1 Pedestrian signals at junctions have the advantage that safety is improved by restricting the pedestrian movement to a shorter period of time during a signal cycle. It also has the advantage that the capacity of the left-turn vehicular movement is increased.
- 2 Pedestrian signals can be considered when exclusive vehicular left- or right-turn phases are provided that conflict with pedestrian movements (alternatively, PEDESTRIAN PROHIBITED SIGNS R218 may be posted). However, pedestrians do not have right of way when no pedestrian signals are provided and flashing green signals are displayed.
- 3 Pedestrian signals may also be provided on one-way roads where vehicular signals are provided only in the one direction and no signals are available in the other direction.
- 4 Pedestrian signals should be considered when large numbers of pedestrians cross the road and pedestrians can impede turning traffic. A capacity analysis can be undertaken to establish whether pedestrian signals would improve the traffic flow.
- 5 Pedestrian signals may be considered on an approach when the pedestrian volume crossing the particular approach multiplied by the volume of conflicting turning traffic exceeds 10 000 in any one hour, or 5 000 for each of any four hours of a day.
- 6 Pedestrian movements across slipways at junctions may be signalled where warranted by pedestrian queues or delays, or when pedestrians require additional protection due to special conditions such as high vehicle speeds, poor sight distance and pedestrian disabilities.

7 The non-observance of traffic signals by pedestrians may create capacity problems for turning movements at junctions. This problem can be reduced by providing protected turning phases for vehicles, during which a RED MAN LIGHT SIGNAL is displayed. A pedestrian green signal can be displayed during the main signal phase.

#### 4.5 PEDESTRIAN SCRAMBLE PHASE

- 1 The pedestrian scramble phase is also known as an exclusive or serial pedestrian phase. Such a phase allows only pedestrians to walk across the junction while all vehicles receive RED LIGHT SIGNALS and are not allowed to enter the junction from any approach. Provision can also be made for the *diagonal* crossing of the junction by pedestrians.
- 2 The main advantage of the scramble phase is that it can eliminate pedestrian-vehicle conflict, thus improving the level of safety. This, however, will only be achieved if full pedestrian compliance of the light signals can be obtained. In practice, pedestrians may utilise the scramble phase as well as the vehicular phases to cross the junction.
- 3 The capacity of turning movements at junctions can be improved by the provision of scramble phases (but only when pedestrians do not violate the light signals). The capacity of straight-through movements, however, is significantly reduced by scramble phases.
- 4 Scramble phases can be effectively utilised in pedestrian precincts where vehicular capacity is of less importance. Such phases can create an environment in which priority is given to pedestrians and vehicular traffic flow is of less concern.

#### 4.6 LAYOUT OF PEDESTRIAN AND PEDAL CYCLIST SIGNALS

- 1 A pedestrian signal face Type S11P or a pedal cyclist signal face Type S11C is provided for each direction of movement at a junction or mid-block crossing (both sides of the roadway).
- 2 The signal faces may be mounted on the same posts as vehicular signal faces, either parallel or perpendicular to the vehicular faces as shown in Figure 4.1. The following criteria should be used in selecting posts for the mounting of pedestrian signal faces:
  - (a) The signals should be in line with the pedestrian crossing, at a position where pedestrians can readily see the signals.
  - (b) The signals should not be located at a position where vehicles stopping at, or slightly beyond, the stop line may obstruct the visibility of the signals. Attention must particularly be given to the possible obstruction of the signal face by buses and heavy vehicles.
  - (c) The signal posts should not impede the flow of pedestrian traffic.
  - (d) The number of signal posts should be restricted to avoid clutter on the sidewalk and to reduce installation and maintenance costs.
- 3 Where no vehicular light signals are provided, consideration can be given to providing a second pedestrian or pedal cyclist signal face as a backup should one of the signals fail.

- 4 At signalised mid-block pedestrian or pedal cyclist crossings, type S1 traffic signal faces shall be used to control vehicular traffic. There shall be at least two S1 traffic signal faces for each approach on the far side of the stop line, as shown in Figure 4.2. A supplementary S1 signal face is also recommended on the near side of the crossing, not further than 3 m from the prolongation of the stop line.
- 5 The S1 signal faces on the far side SHALL be not less than 3 m apart and not more than 20 m apart. Additional overhead mounted S1 signal faces SHALL be provided if the faces are more than 20 m apart (preferably more than 16 m apart). On a divided carriageway road with a median of adequate width, the right-hand S1 signal face SHALL be located on the median island.
- 6 The left-hand S1 signal faces should not be located more than 2 m laterally from the edge of the roadway.
- 7 On very wide roads, the time required by pedestrians to clear a crossing may be excessive. Consideration can then be given to the possibility of providing a staggered pedestrian crossing as shown in Figures 4.3 and 4.4. Such crossings can be crossed during two signal cycles, which reduces the clearance time that must be provided during one signal cycle.
- 8 Pedestrian crossing lines or blocks may not be less than 2,4 m wide, but a width of 3,0 m is preferred. Where large volumes of pedestrians are present, the width can be increased (but not more than a recommended maximum of 5 m). The minimum distance between the pedestrian crossing lines or blocks and the stop line (RTM1) is 1 m at junctions and 3 m at mid-block crossings.

#### 4.7 MOUNTING OF PEDESTRIAN AND PEDAL CYCLIST SIGNALS

- 1 Pedestrian and pedal cyclist signal mounting details are shown in Figure 4.6. The signals should preferably be post-mounted. The signals should have a minimum clearance above the sidewalk of not less than 2,1 m. The signal face should be not more than 3,0 m above the level of a point on the road surface nearest to the post, measured to the centre of the lowest (green) light signal.
- 2 **Where the pedestrian or pedal cyclist signal face is mounted adjacent to a vehicular signal face, the red man or pedal cyclist signal aspect SHALL not be mounted higher than the level of the lowest vehicular green signal aspect.** The pedestrian or pedal cyclist signal faces should not be located in a line vertically with any vehicular signal aspect facing the same direction and should be offset to the left or right of such signal aspect.
- 3 The pedestrian or pedal cyclist push button should be mounted approximately 1,1 m above the sidewalk surface. A pedestrian or pedal cyclist sign should preferably be placed immediately above or below the push button. Preferred locations and directions of push buttons are shown by the hand symbols in Figures 4.1 to 4.4.

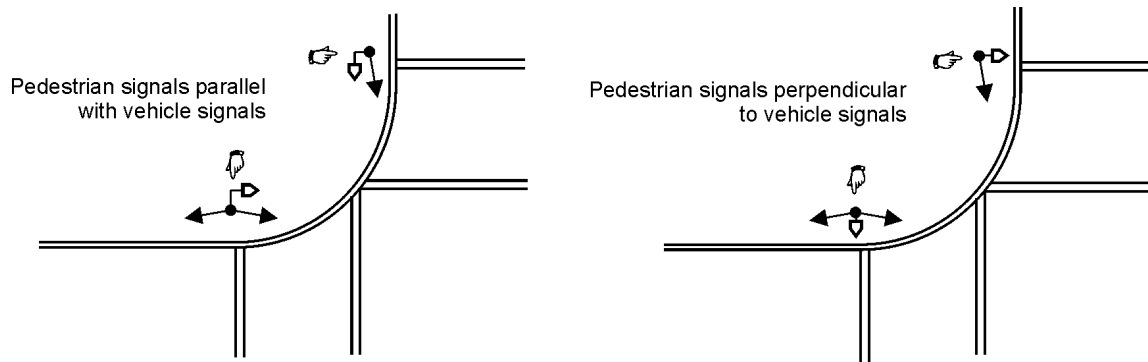

Figure 4.1: Alternative positions for pedestrian and pedal cyclist signals at signalised junctions

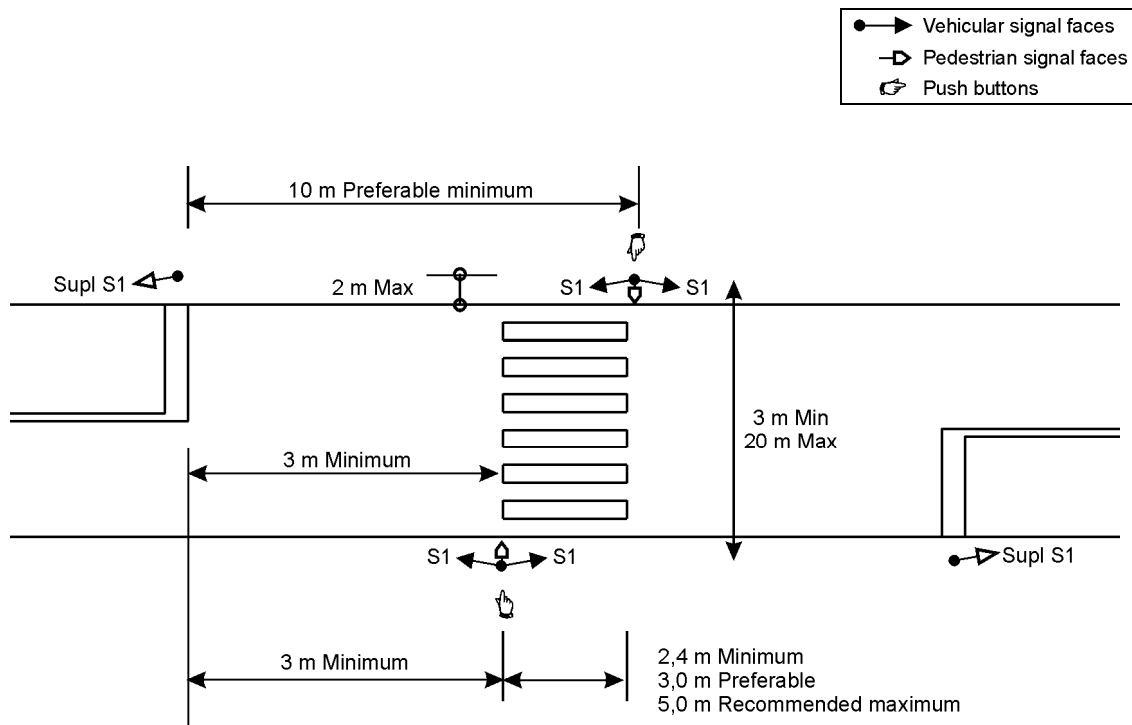

Figure 4.2: Pedestrian (and pedal cyclist) signal faces at a mid-block crossing



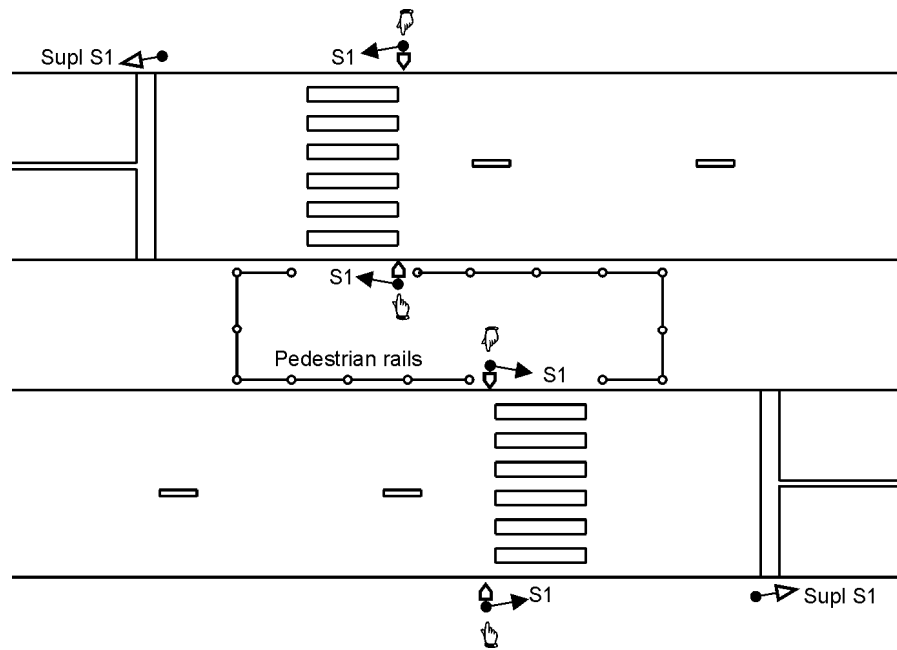

Figure 4.3: Staggered mid-block pedestrian crossing

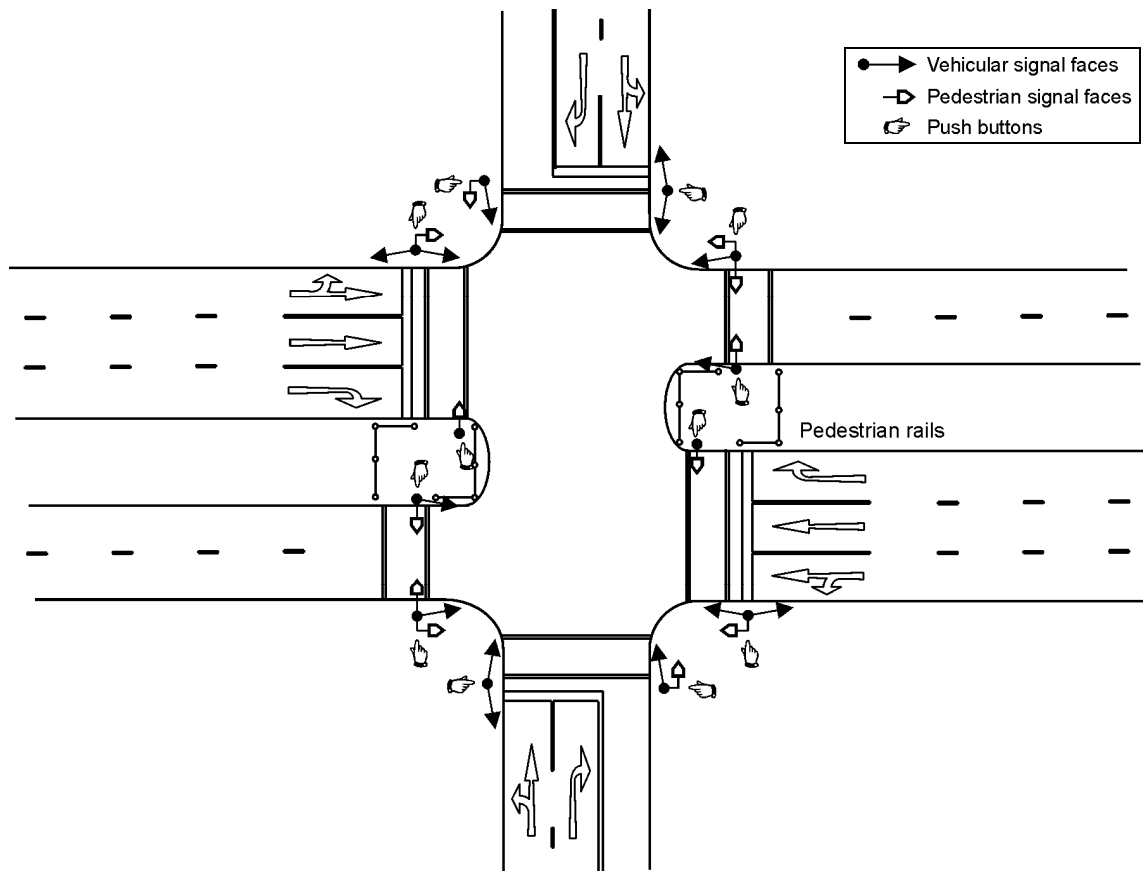

Figure 4.4: Staggered pedestrian crossing on a wide junction

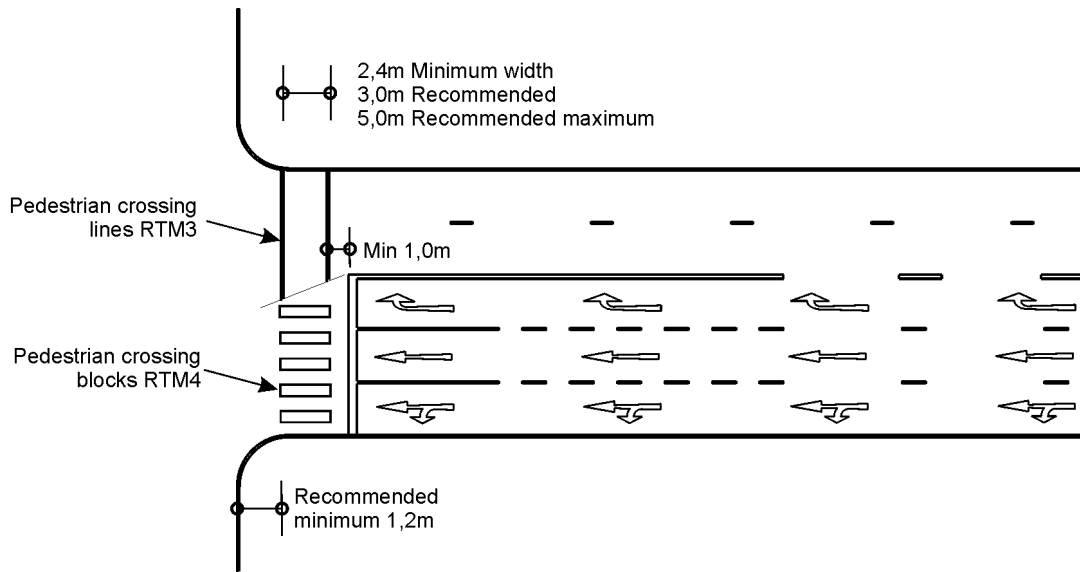

Figure 4.5: Pedestrian crossing road markings at a junction

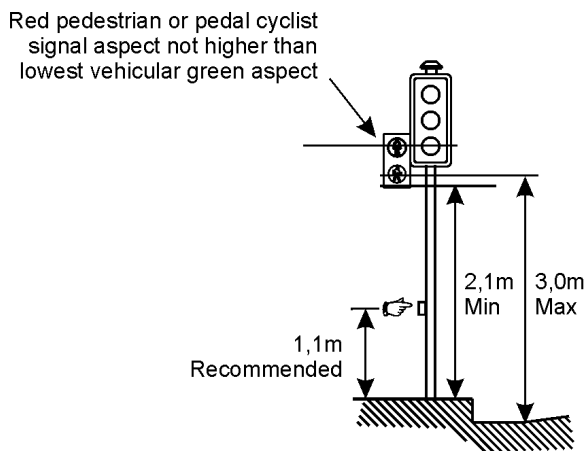

Figure 4.6: Mounting pedestrian and pedal cyclist signals

## CHAPTER 5: JUNCTION LAYOUT

### 5.1 INTRODUCTION

- 1 The layout of a road junction or pedestrian crossing and its approaches should be carefully designed to allow the safe and efficient operation of traffic signals. Geometric and other improvements are often required at a junction before signals can be installed.
- 2 The objectives of improving road geometry at a signalised junction include the following:
  - (a) to reduce conflict and thus improve safety;
  - (b) to promote efficient traffic flow; and
  - (c) to reduce construction and maintenance cost.
- 3 Installation of traffic signals without due regard to the above requirements may result in an inefficient or unsafe situation, associated with high user cost. It is therefore imperative that appropriate geometric improvements should be carried out as a part of the traffic signal installation project, and be included in the implementation programme and budget.

### 5.2 GEOMETRIC DESIGN OF SIGNALISED JUNCTIONS

#### 5.2.1 General

- 1 Geometric design standards of signalised junctions are given in a variety of design manuals. These include the TRH17 and UTG manuals of the Committee of State Road and Urban Transport Authorities (see bibliography). These manuals can be supplemented by manuals from other countries, such as the AUSTRROADS (1988) and AASHTO (1995) manuals.
- 2 The geometric design manuals address general road and junction geometric design standards. The intention of this chapter is not to repeat these standards, but to provide supplementary guidelines applicable to signal controlled junctions.
- 3 The geometric design of signal controlled junctions differs in a number of important aspects from the design used at priority controlled junctions. It is therefore important that even at locations where signals are not currently warranted, a decision must be made on the possibility of future signalisation. The main differences are:
  - (a) Operations at priority controlled junctions can be improved by increasing corner radii and by providing tapers, but this creates difficulty in positioning traffic signals and providing for pedestrians. At signalised junctions, smaller corner radii may be required.
  - (b) At priority controlled junctions, shoulder widths and through lanes are normally maintained through the junction. At signalised junctions, the number of lanes is commonly increased to improve capacity, and the shoulders eliminated to improve signal positioning.

#### 5.2.2 Factors influencing geometric design

- 1 The geometric design of a signalised junction is influenced by a number of factors, such as traffic volumes, human factors, vehicle factors, topography, and economic considerations.
- 2 A junction must be able to accommodate peak-hour traffic volumes efficiently and safely. This is particularly important at signalised junctions that carry large volumes of traffic, and where additional lanes may be needed to provide the required capacity to accommodate the traffic.
- 3 The human factor is a particular important element in the design of signalised junctions. Humans are inclined to act according to habit - they may become confused when surprised, and tend to be inattentive at times. These factors make it essential that uniform and proper design standards should be utilised at junctions.
- 4 The design of a junction should make provision for the type of vehicle anticipated to use a particular junction. Use can be made of turning templates to establish "swept paths" through a junction.
- 5 The topography as well as the environment are important factors often restricting the geometric design of a signalised junction. Compromises in design are often required due to topographical and environmental restrictions.
- 6 The cost of providing high design standards at signalised junctions is often a restricting factor. However, significant improvements can often be achieved by relatively minor low-cost improvements.

#### 5.2.3 Spacing of signalised junctions

- 1 The spacing of signalised junctions (and pedestrian crossings) on two-way roads is one of the most important factors affecting efficiency and road safety in signalised networks.
- 2 Optimal co-ordination on two-way roads depends on a large number of factors, and while it is not possible to provide detailed recommendations regarding junction spacing that would optimise co-ordination, a minimum distance of 500 m is generally required. Factors influencing co-ordination include traffic patterns, speeds, cycle length, signal phasing, queue lengths, etc. In general, however, longer cycles and higher speeds require signals to be spaced further apart. Each situation should be investigated depending on particular circumstances.
- 3 On one-way arterials (not in networks), co-ordination can be achieved relatively easy for any spacing of junctions. The spacing of traffic signals on one-way roads is therefore less of an important factor, except that minimum requirements should be met.
- 4 The distance at which signals can be spaced apart depends on maximum expected queue lengths. Short block lengths often lead to the blocking of upstream junctions, which have an adverse effect on network operations.

### 5.2.4 Conflicting manoeuvres at junctions

- 1 In the design of junctions, consideration must be given to the different types of conflicting traffic manoeuvres that can occur in a junction. These are:
  - (a) Diverging manoeuvres that occur when a traffic stream splits into two separate streams.
  - (b) Merging manoeuvres that occur when two traffic streams merge into one.
  - (c) Weaving manoeuvres that occur when traffic streams cross each other by lane changing.
  - (d) Crossing manoeuvres that occur when one traffic stream crosses another at near right angles.
- 2 Where possible, junction design should eliminate or reduce conflicts, or at least avoid multiple manoeuvres, which combines two or more of the above manoeuvres. Multiple manoeuvres should where possible, be replaced with a series of elemental ones. Such manoeuvres should preferably be separated by at least *two* or *three seconds* of travel time.
- 3 Diverging, merging and weaving manoeuvres should be designed for low RELATIVE speeds between conflicting traffic streams. This means that the angle of intersection of the streams should be relatively small, and vehicles should preferably be travelling at about the same speeds when the manoeuvres are made. This could mean that acceleration or deceleration lanes may be required to achieve desired operating speeds.
- 4 Crossing manoeuvres should be made at approximately right angles to minimise driver estimation errors. To achieve this, the angle of intersection between approach roads should preferably be 90 degrees. Angles of down to 70 degrees, however, would also be acceptable. Where possible, geometric improvements should be introduced to achieve such angles.

### 5.2.5 Sight distance requirements

- 1 Good junction design requires that proper attention should be given to sight distance requirements. The provision of adequate sight distance is fundamental to safe signal operations.
- 2 The following sight distances are of importance at traffic signals:
  - (a) Stopping sight distance required by vehicles to stop for hazardous objects on the roadway or in the junction. Minimum stopping sight-distances are given in the various geometric design manuals.
  - (b) Sight distance required for traffic signal faces as given in Chapter 3 of this manual (Volume 3).
  - (c) Sight distance required by right-turning traffic when seeking gaps in an opposing conflicting stream. This sight distance can be established using Figure 2.7: *Shoulder sight distance for stop condition* given in Volume 1 of the Road Traffic Signs Manual.
- 3 It is not necessary to provide shoulder sight distance on the approaches to signals that may be out of order since drivers must treat such signals as 3-way or 4-way stop controlled junctions.

### 5.2.6 Design vehicles

- 1 The design of a junction should make provision for the types of vehicles expected to use the junction, to carry out turning movements with adequate space for their swept paths.
- 2 Turning templates are used for the design of junctions. These templates indicate the "swept path envelope" for various angles for turn. Provision should be made to accommodate such swept paths plus a minimum clearance of 600 mm on each side of the path.
- 3 Some turning templates have been developed for vehicles travelling at crawl speeds to establish absolute minimum design standards. Vehicles turning at such speeds, however, would lead to a deterioration of operations at traffic signals. Templates that provide for vehicles turning at higher speeds should therefore preferably be used.
- 4 Where provision must be made for particularly difficult turning movements through a junction, care should be taken to check turning paths from all likely positions the junction can be approached from by the design vehicle, and not only one ideal position. This is particularly important where wide approach lanes are provided, but the vehicle must negotiate a narrow path through the junction.

### 5.2.7 Lane widths

- 1 Lane widths for straight-through movements at a traffic signal should preferably not be narrower than 3,3 m, although a width of 3,0 m can be resorted to where insistence on the 3,3 m would mean that a right-turn lane cannot be provided. Where there are significant volumes of heavy vehicles, lane widths can be increased to about 3,5 m.
- 2 Lane widths for left- and right-turn lanes should preferably not be narrower than 3,0 m, although a width of 2,7 m (and even 2,5 m) can be accepted if it would otherwise again mean that a right-turn lane cannot be provided. Where significant volumes of heavy vehicles utilise the turning lanes, the turn lane may be increased to 3,3 m or more.
- 3 Double and triple turning lanes should be at least 3,3 m and preferably 3,5 m wide on the approach to the junction. Wider widths will be required on the exit side of the junction to accommodate the paths of the turning vehicles. If a median is provided on the exit side, a wider exit width can be achieved by either reducing the width of the median or by setting the median back from the junction.
- 4 An offset of 0,3 m should preferably be provided between the kerb face and the edge of the roadway.
- 5 The widths of exit lanes at junctions should be sufficient to accommodate the swept paths of turning vehicles, particularly when double or triple turning lanes are provided, or where only one exit lane is available. Such exit lanes should preferably be at least 3,5 m wide, but a width of between 4,0 m and 4,5 m may be required. Where significant volumes of heavy vehicles turn right, the required widening should be established by means of turning templates.

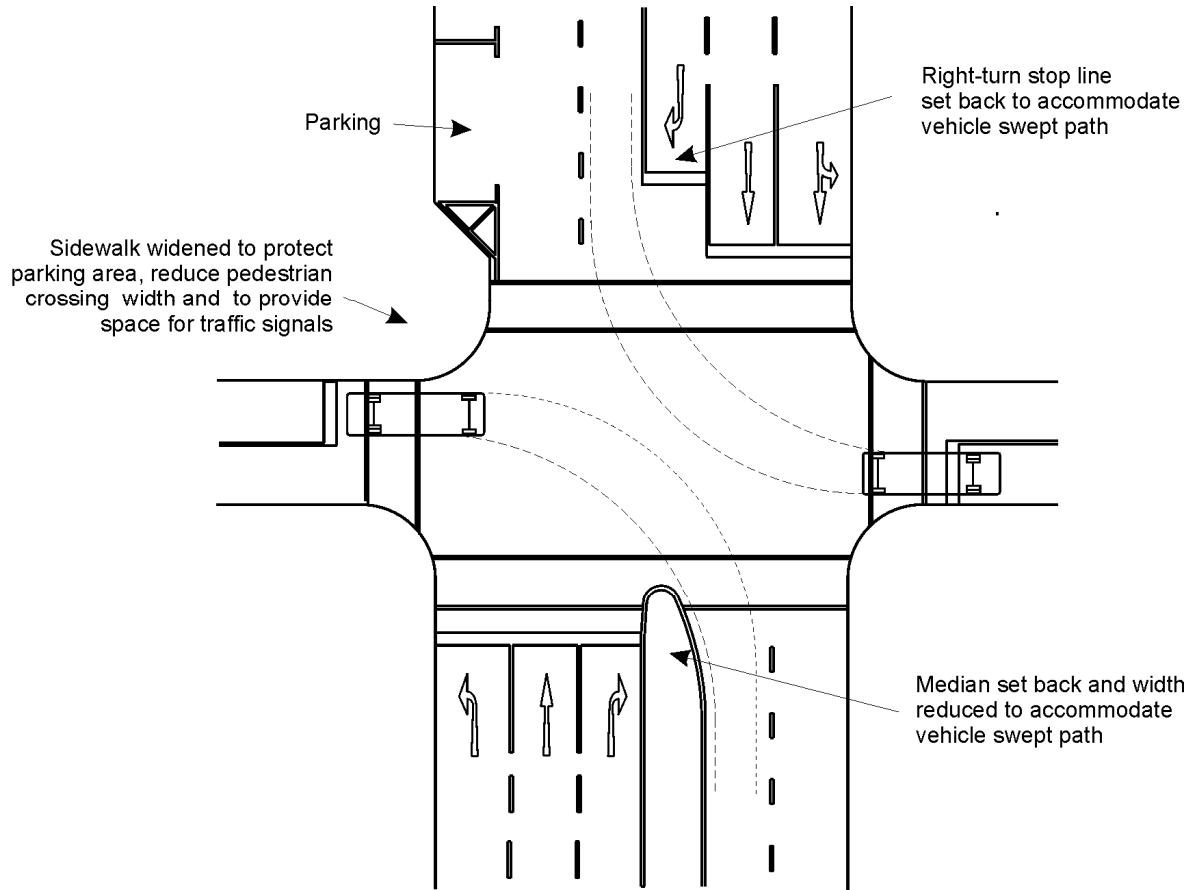

Figure 5.1: Vehicle swept paths through a signalised junction

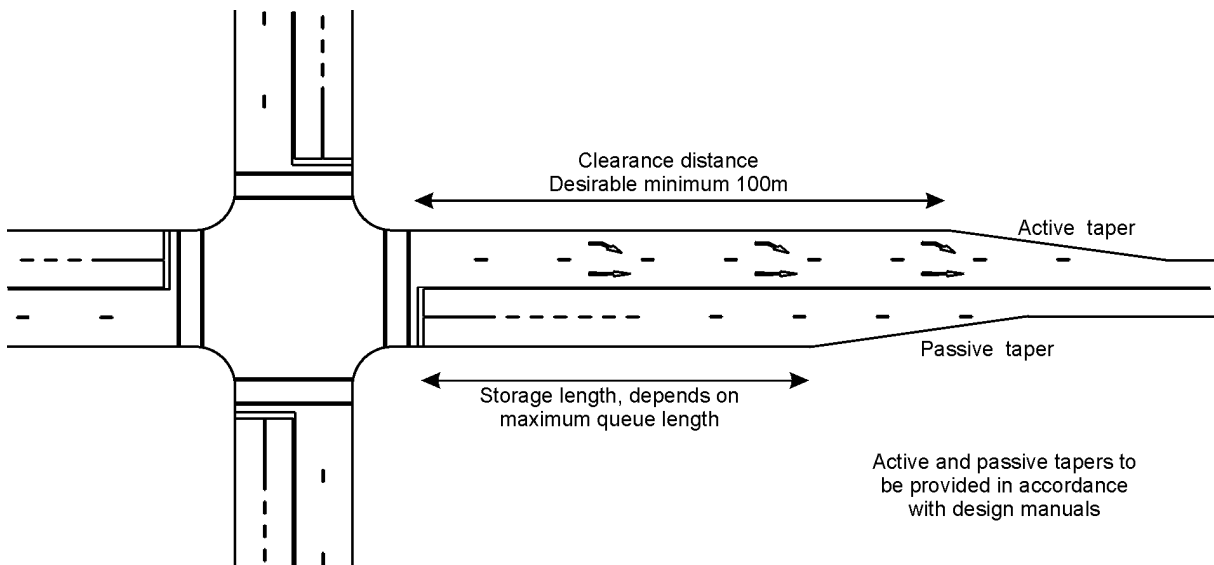

Figure 5.2: Auxiliary through lanes at signalised junctions

- 6 Where a right-turn movement turns into a two-way road, the stop line on the exit side of the junction can be set back to provide space for the movement. Where a median is provided, the exit lane can be widened by either setting the median back from the junction or by reducing the width of the median locally. The different options are shown in Figure 5.1.

### 5.2.8 Median widths

- 1 The width of a median should generally not be less than 1,2 m. This is the minimum requirement to accommodate road traffic signs such as the "keep left" sign.
- 2 At signalised junctions, however, a width of 1,2 m would not be sufficient to accommodate a traffic signal because of the recommended clearance distance of 0,5 m. Assuming a backboard width of 0,5 m and a clearance distance of 0,5 m on both sides of the backboard, a median width of 1,5 m is required to accommodate a single signal face, while a width of 2,0 m is required to accommodate two signal faces side by side. A minimum median width of 2,0 m is therefore generally recommended near signalised junctions.
- 3 On narrow medians, where insistence on the 0,5 m clearance would mean that signal faces cannot be provided on the median, the lateral clearance can be reduced to an absolute minimum of 0,1m, but only if the camber or crossfall of the roadway falls away from the median. In such a case, it would be possible to install two signal faces on a 1,2 m wide median.
- 4 A minimum median width of 2,0 m is desirable where it is necessary to accommodate pedestrians or pedal cyclists. Wider medians may be required where large volumes of pedestrians must be accommodated.

### 5.2.9 Junction corners

- 1 Corner kerb turn radii at signal controlled junctions of between 8 and 10 m are normally desirable, but radii as small as 6 m and as large as 12 m can be used. Corner radii below 8 m lead to left-turning vehicles making wider turns, and encroachment onto adjacent lanes. Radii above 10 m, on the other hand, lead to an increase in turning speeds that could affect the safety of pedestrians. The larger radii also create problems with the positioning of traffic signals.
- 2 At locations where significant volumes of heavy vehicles use the junction, the above corner turn radii could be inadequate. In such cases, slipways may be required to accommodate left-turn movements.
- 3 Where parking is provided, it is preferable to widen the sidewalk area at the corner of the junction, as shown in Figure 5.1. Such widening serves to protect the parking area and it allows for the closer positioning of traffic signal faces to the roadway. Another advantage is that it reduces the clearance time required by pedestrians to cross the junction.
- 4 Barrier or semi-mountable kerbs should be used on the corners of signalised junctions to prevent parking on the corners. Provision should also be made for recessed pedestrian ramps at the corners.

## 5.3 AUXILIARY LANES

### 5.3.1 Auxiliary through lanes

- 1 Auxiliary through lanes are sometimes provided at signalised junctions to improve capacity. An example of a junction with such lanes is shown in Figure 5.2.
- 2 The length of the auxiliary through lane on the approach to a junction depends on the amount of storage required to accommodate the queue length waiting at the traffic signal. The auxiliary through lanes should be terminated well clear of the junction, desirably 100 m minimum beyond the junction (excluding the taper).
- 3 Adequate active and passive taper rates should be provided in accordance with standards provided in design manuals. Care must be exercised with the location of the merging (active) taper to ensure that there is sufficient sight distance for the approaching driver to perceive the merge and have adequate time for relative speed adjustment and gap selection for merging.

### 5.3.2 Left-turn auxiliary lanes

- 1 The left-turn does not have the same impact on the safe and efficient operation of a signalised junction as the right-turn movement (except where left-turning movements are hampered by high volumes of pedestrians). This, however, does not mean that left-turn auxiliary lanes are not required. In many instances, it may be possible to improve signal operations and safety significantly by introducing left-turn lanes.
- 2 Left-turn lanes have the advantage that decelerating turning traffic is removed from the through lanes, thus improving operations on such lanes. It could also be more cost effective to add a left-turn lane than to increase the number of through lanes.
- 3 A left-turn lane can be of particular advantage when a left-turn phase can be provided when the right-turn movement from the left is given a separate phase. At many T-junctions, there is an opportunity to provide such a left-turn phase, and the provision of a left-turn lane can often be more readily justified at such junctions (except when pedestrian signals are required to accommodate pedestrians).
- 4 Left-turning lanes are most effective when significant volumes of traffic turn left, the traffic signal has insufficient capacity to handle peak-hour traffic (due to pedestrians), and the provision of a left-turn lane would be the most cost-effective solution to increase the capacity of the junction.

### 5.3.3 Right-turn auxiliary lanes

- 1 The right-turn movement is of particular importance at signalised (and also other) junctions. Even one vehicle wanting to turn right at a junction, and having to wait because of limited gaps in the opposing flow, will impede other traffic and could create unsafe operating conditions. Exclusive right-turn lanes at a traffic signal will be warranted at most locations where signals are warranted.
  - 2 Right-turn lanes not only contribute to improved capacity, but also have a significant safety benefit. In many cases, right turn lanes can be warranted based on their **safety** benefits alone, rather than the capacity improvements that can be achieved. Relatively few right-turn vehicles can cause severe disruptions that could lead to accidents, although sufficient capacity may be available at a junction.
  - 3 The need for right-turn lanes to improve safety depends on the speed on a road as well as the probability of conflicts between the right-turn and other traffic travelling in the same direction. On high-speed roads, a right-turn lane will be justified, even if very low volumes of traffic turn right. On roads with low operating speeds, a higher degree of conflict can be accepted.
  - 4 In general, right-turn lanes should be provided at all traffic signals, except where operating speeds are low (50 km/h or less) or where very few conflicts occur between right-turn and other traffic movements (either because of low volumes of right-turners or low volumes of opposing traffic movements). A cost-benefit analysis can be undertaken in which the benefits accruing from the provision of a right-turn lane can be compared with the cost of providing such a lane.
  - 5 Right-turn lanes can also be justified on **capacity** grounds. A capacity analysis would indicate whether such lanes are required. Where right-turn traffic volumes exceed 300 vehicles in the peak hour, provision of a double right-turn lane may be considered. Triple right-turn lanes can also be considered, but normally only on one-way streets and on the side approaches of T-junctions.
- 3 The painted island design has the advantage that it is significantly more visible than the second design, particularly at night. However, in urban areas where street lighting is provided and speeds are relatively low, the design without the island is adequate. This design has the advantage that the S-type of manoeuvre required to make a right-turn associated with a painted island, is eliminated.
  - 4 When traffic signal face S1R is used (in combination with traffic signal arrow sign ST2) to control a right-turn movement, separate right-turn lanes must be provided. Such lanes should be separated from other lanes by a WM2 CONTINUITY LINE, a RM5 PAINTED ISLAND or a constructed island.
  - 5 In the design of right-turn lanes, it is important that sufficient sight distance should be provided to avoid the possibility of head-on conflict. The sight-distance of right-turning vehicles is often obstructed by a queue of right-turning vehicles in the opposite direction. Two examples of this problem are shown in Figures 5.4 and 5.5. Possible methods of addressing these problems are discussed.

### 5.3.5 Double and triple right-turn lanes

- 1 Double or triple left and right-turn lanes can be provided at junctions provided that there is adequate space on both the approach to, and exit from, the junction. The capacity for turning traffic can be significantly improved by providing such lanes (triple right-turn lanes would normally only be considered on one-way streets and on the side legs of T-junctions).
- 2 For the right-turn movement, the provision of double or triple turn lanes can impair lines of sight. Protected-only right-turn phases should therefore be considered when such lanes are used.
- 3 It is strongly recommended that use should be made of guide lines through the junction when double or triple lanes are provided. Such lines are needed to discourage encroachment between the turning lanes and to reduce the possibility of sideswipe accidents between vehicles.
- 4 The guide lines should allow for the largest type of vehicle anticipated to make the right-turn movement. Turning templates are used to establish the turning paths of two or three heavy vehicles turning right at the same time.

### 5.3.6 Length of right-turn lanes

- 1 Standards for the lengths of right-turn lanes are given in the design manuals. These lengths are normally determined based on the expected 95<sup>th</sup> percentile queue length in the peak hour. The lengths should be checked against the queue in the adjacent through lane and the longer queue used to ensure that turning vehicles are not blocked from entering the turn lane.
- 2 On high-speed roads where expressway type conditions are required, an appropriate deceleration length may be added to the storage length requirement to ensure optimum and safe traffic flow. At traffic signals, it is generally more important to provide the storage space than a deceleration length.

### 5.3.4 Design of right-turn lanes

- 1 Right-turn lanes can be introduced by utilising a number of different methods, as shown in Figure 5.3. In the north-south direction, the approach lanes are narrowed to accommodate the right-turn lanes and the lanes delineated by using road markings. The turning lanes in the east-west direction are provided inside a constructed median.
- 2 Two methods of delineating right-turn lanes by means of road markings are shown in Figure 5.3. From the north, a painted island is utilised to provide greater protection to right-turn movements. From the south, no such island is provided and WM2 CONTINUITY LINES are used to demarcate the turning lane.

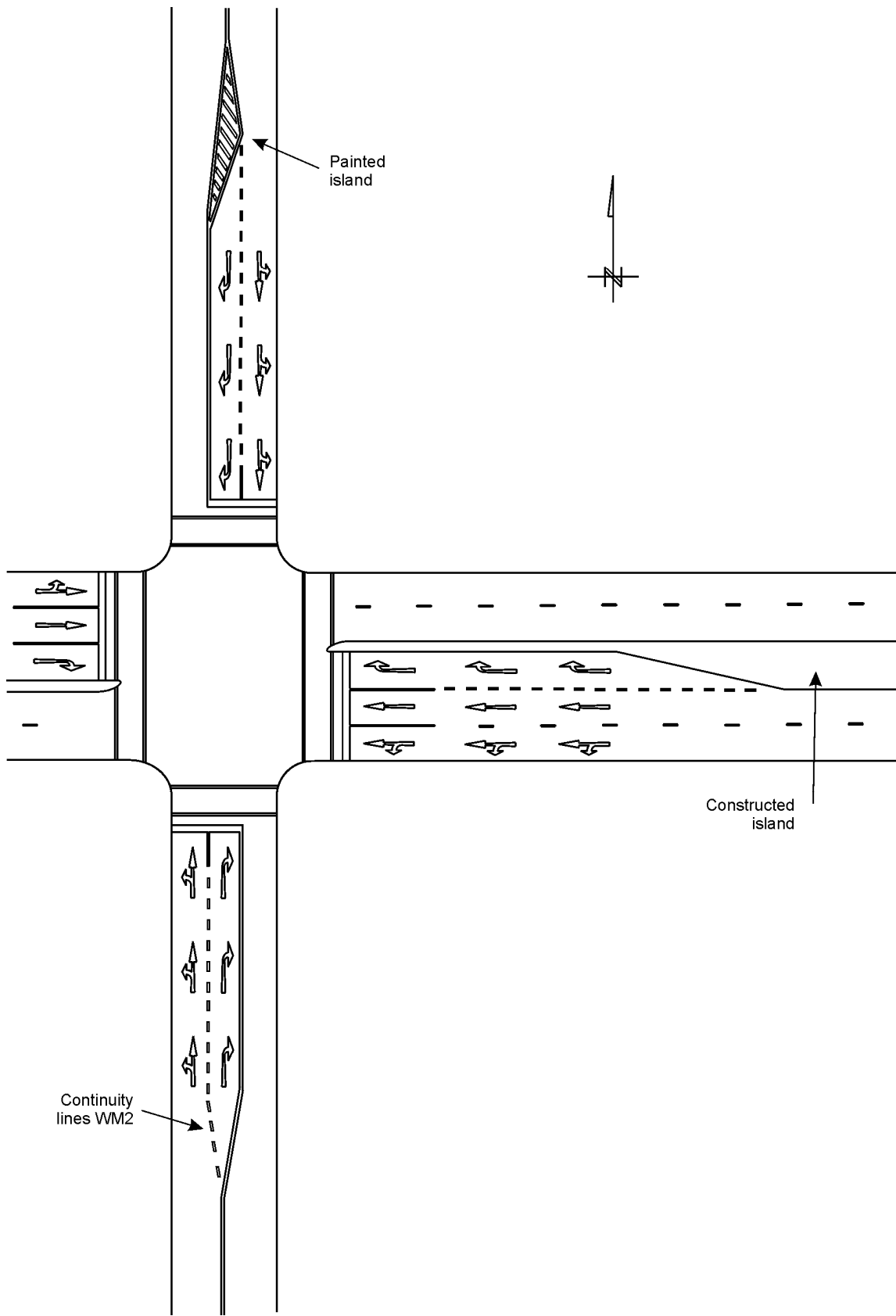
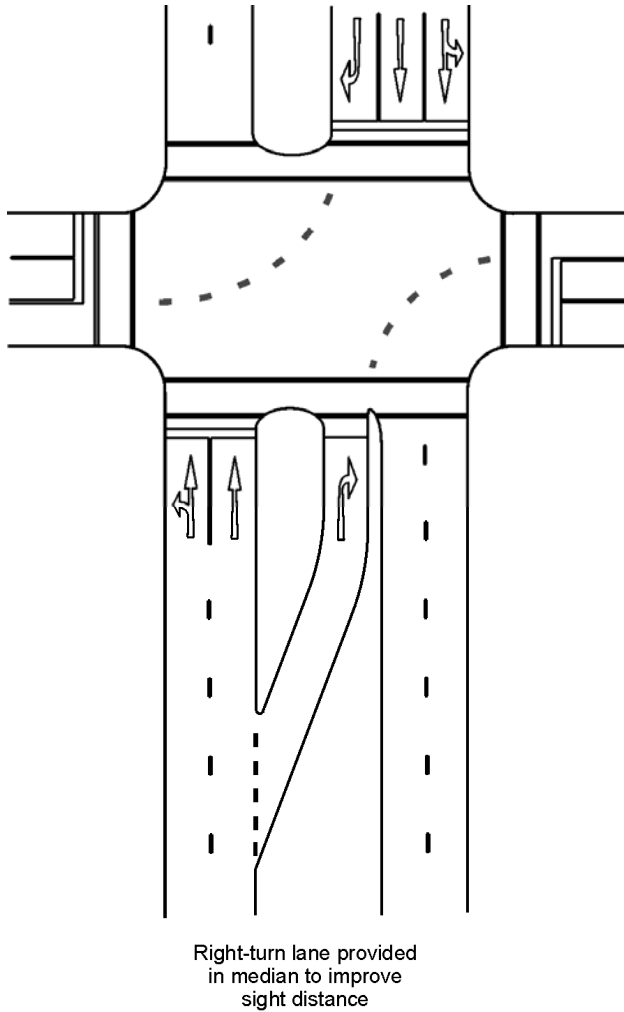

Figure 5.3: Provision of right-turn lanes at a signalised junction





In this figure, sight distance is obstructed due to the provision of a very wide median and the queue of right-turning vehicles forming in the opposite direction. A possible geometric improvement that can be considered at such a junction is to provide the right-turn lane in the median, as indicated in the figure.

**Figure 5.4: Restricted sight distance for right-turning traffic due to a very wide median**

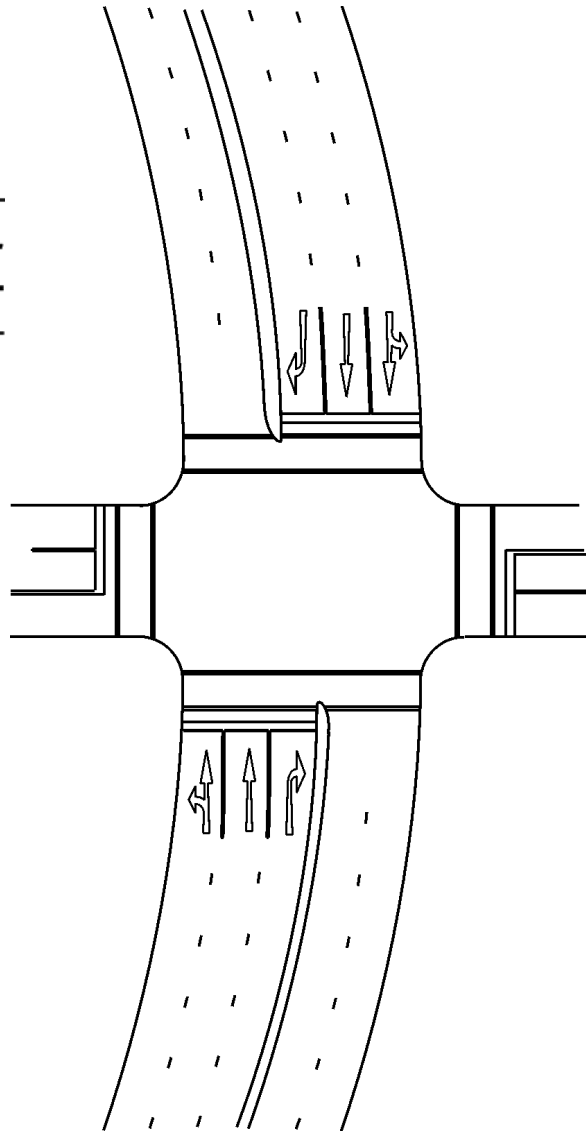

In this figure, sight distance is obstructed due to the horizontal curve on the road and the queue of right turning vehicles forming in the opposite direction. A possible remedy for this problem is to provide a protected-only right-turn phase. Note that this problem only occurs in the one direction (bottom-to-top) and not in both directions.

**Figure 5.5: Restricted sight distance for right-turning traffic due to a horizontal curve (bottom-to-top direction)**

- 3 In establishing the required right-turn storage lengths, it is important that attention be given to future requirements. This means that traffic volumes and patterns must be predicted for the design year. As with the geometric design of other elements of a junction, the length of the turning lane should be designed to accommodate such design year traffic volumes.
- 4 As a minimum, provision should be made for storage space for at least two vehicles in the right-turn lane (about 12m). However, it is more desirable to provide a storage space for at least five vehicles (about 30 m). Typically, storage spaces vary between 30 to 60 m, depending on right-turn volumes.

### 5.3.7 Slipways

- 1 A slipway is a roadway that passes to the left (or in the case of one-way systems, to the right) of the main junction without intersecting the main junction. Slipways can be controlled or free-flow as shown in Figure 5.6.
- 2 Slipways at signalised junctions, may be required under the following circumstances:
  - (a) When provision has to be made for large turning vehicles, and the corner turn radius cannot be increased to accommodate such vehicles.
  - (b) At skew junctions where the normal treatment would lead to a large junction.
  - (c) Where improved operations and capacity are required for the turning movement.
- 3 **Controlled slipways** are controlled by a traffic signal or a yield or stop sign. The following are a number of considerations that should be taken into account:
  - (a) YIELD control should only be used when adequate shoulder sight distance is available. STOP control is otherwise used. Such sight distance is required to allow drivers to view straight-through vehicles from the right as well as vehicles turning right from the opposite approach.
  - (b) The angle of entry of a controlled slipway should not be less than 70 degrees relative to the crossroad (with the stop line angled at a maximum of 20 degrees). A sharper angle not only increases driver discomfort, but also leads to speeding, which could result in unsafe operating conditions.
  - (c) The controlled slipway is treated as a separate junction operating independently of the main signalised junction. This creates no problem when a slipway is yield or stop controlled. Signalised slipways, however, have the problem that signals are normally not provided on the main road and that potential conflicts must therefore be prevented at the main junction. **All conflicting movements at the main junction, including the right-turn movement from the opposite direction, must face a red light signal while the slipway receives a green signal.** This would require the provision of a protected-only right-turn phase for right-turning traffic from the opposite approach.
- 4 **Free-flow slipways** allow for free-flow turning movements at relatively high speed. The following are a number of important considerations in the design of such slipways.
  - (a) The radius adopted for the slipway should preferably allow for a relatively high operating speed.
  - (b) Due to the high operating speeds, free-flow slipways are only appropriate when there are very low volumes of pedestrians.
  - (c) An acceleration lane of sufficient length should be provided on the exit side of the slipway.
  - (d) The slipway design should prevent vehicles making wide turns directly onto the crossing road. A short median can be provided on the exit side of the slipway to direct vehicles onto the acceleration lane.
- 5 Free-flow slipways can improve operations significantly when they are properly designed using appropriate design standards (and there are no or few pedestrians).
- 6 Yield (or stop) sign controlled slipways have the advantage that turning traffic movements do not have to stop at the traffic signal.
- 7 Signal controlled slipways have the following disadvantages:
  - (a) The opportunity for gap acceptance is not available.
  - (b) Right-turning movements on the main junction must be prohibited when the slipway receives a green light signal.
  - (c) Although the saturation flow of the left-turn movement at a traffic signal can be slightly increased by providing a signalised slipway, it does not mean that the capacity of the junction can be increased. In many instances, capacity could in fact be reduced, particularly if additional signal phases must be introduced to accommodate opposing right-turn movements.
- 8 Signalisation of slipways may be required on double or triple lane slipways due to possible sight distance problems. It is, however, important to reiterate that such signalisation should only be provided when a permanent protected-only right-turn phase is provided on the opposite approach at the main junction.

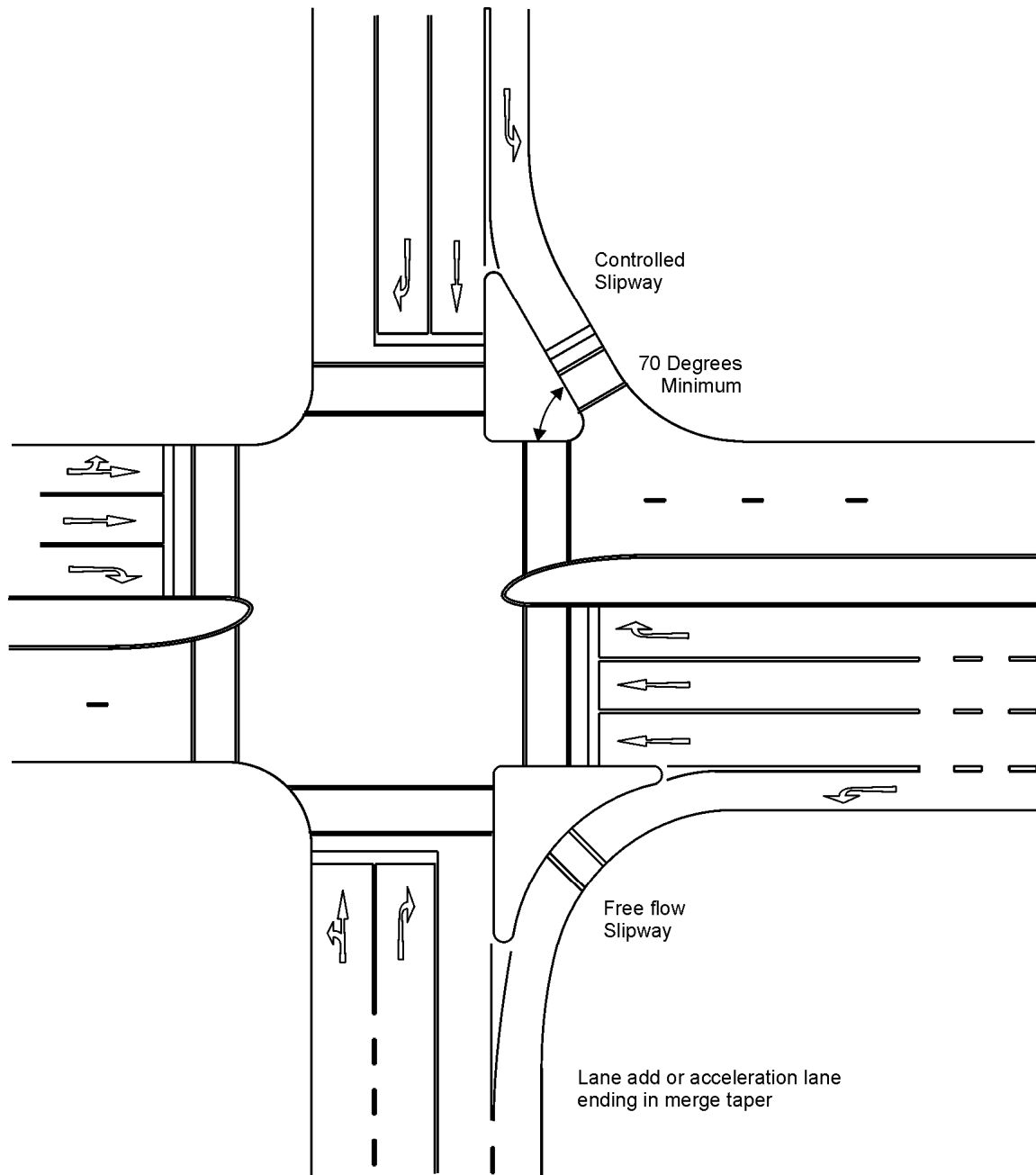

Figure 5.6: Free-flow and controlled slipways at a signalised junction

## 5.4 ROAD SIGNS

- 1 The National Road Traffic Regulations allow for the use of various road signs at traffic signals. There are, however, a limited number of road signs that may be used in conjunction with a traffic signal. These signs are the following (these signs have also been listed in Chapter 3 of this manual):
  - (a) a street name sign;
  - (b) a direction route marker sign;
  - (c) information signs IN14, IN15 and pedestrian and pedal cyclist signs relating to the function of the traffic signal;
  - (d) a one-way roadway sign;
  - (e) a no-entry sign;
  - (f) a left-turn prohibited, right-turn prohibited or a U-turn prohibited sign;
  - (g) a proceed straight through only, proceed left only, or proceed right only sign;
  - (h) a pedestrian prohibited sign R218; or
  - (i) a traffic signal arrow sign ST1 to ST5;
 The above signs may be mounted on the same post, cantilever or gantry as that of the traffic signal.
- 2 Other signs may not be used in conjunction with a traffic signal, even if the signal is out of order (except where the signals have been masked out). These include the STOP sign R1, YIELD sign R2 and the RIGHT-OF-WAY sign IN7. A slipway at a signalised junction, however, may be STOP or YIELD sign controlled.
- 3 The PEDESTRIAN PROHIBITED SIGN R218 is used to prohibit pedestrians from proceeding beyond the sign. The sign must be posted on the near side of the junction, in the direction to which it is applicable (and in both directions of the crossing).
- 4 The following information signs related to the operation of traffic signals, may be used at signals:
  - (a) Where signal timings are co-ordinated for a fixed speed, information sign IN14 may be displayed on the relevant exit from a junction.
  - (b) Where a traffic signal has three or more vehicular signal phases, information sign IN15 may be located directly below a signal face.
  - (c) Pedestrian and pedal cyclist information signs.
- 5 The TRAFFIC SIGNAL AHEAD SIGN W301 may be used to warn a road user of the presence of a traffic signal. This sign should be displayed in advance of:
  - (a) Any *new* traffic signal installation. The sign may be removed after a period of three months.
  - (b) Any approach where the approach speed is 70 km/h or more, or where the signal is not visible within 180 m of the junction.
  - (c) A *remotely located* junction or mid-block pedestrian crossing.
- 6 A TEMPORARY TRAFFIC SIGNAL AHEAD SIGN TW301 may be used in advance of any traffic signal that is used temporary at roadworks.
- 7 The TRAFFIC SIGNAL OUT OF ORDER SIGN TW412 may be used to warn a road user that the traffic signals ahead are out of order. If a TRAFFIC SIGNAL AHEAD SIGN W301 is located in advance of the traffic signal, the temporary warning sign TW412 may be placed over the W301 sign for the period the signal is out of order.
- 8 The PEDESTRIAN CROSSING SIGN W306 may be used to warn a road user of the presence of a mid-block pedestrian crossing ahead. The sign should be displayed not less than 90 m or not more than 180 m in advance of the crossing.

## 5.5 ROAD MARKINGS

### 5.5.1 Range of road markings

- 1 Signalisation is applied to a wide range of road junctions. As the traffic handling characteristics of a junction become more complex, so the need for clear and unambiguous road markings becomes greater. Road safety at, and the efficiency of, a junction can be greatly affected by the way in which the approaches to it, and the areas shared by conflicting traffic movements are marked.
- 2 Details related to road markings are given in Chapter 7 of Volume 1 of the Road Traffic Signs Manual. The various types of road markings and their dimensions are summarised in Table 5.1.
- 3 The minimum road markings required at a signalised junction or crossing includes the stop line (RTM1), pedestrian crossing lines (RTM3) and the no-overtaking line (RM1). Additional road markings will be required at more complex junctions.
- 4 Figure 5.7 shows road markings for typical signalised approaches to junctions. Figure 5.8 shows typical guide lines through a junction.

### 5.5.2 Pedestrian crossing lines

- 1 Pedestrian crossing lines (RTM2) are used to indicate the position where pedestrians (or pedal cyclists) may cross at a junction or a mid-block crossing. Block pedestrian crossing markings (RTM4) may also be used instead of the crossing lines at both junctions and mid-block crossings, particularly in locations where pedestrian volumes are high.
- 2 Pedestrian crossing lines (or block pedestrian crossing markings):
  - (a) SHOULD as a general rule be provided at all traffic signal controlled junctions, even if the junction is used by no pedestrians (except where pedestrians are specifically prohibited);
  - (b) MAY be provided without pedestrian or pedal cyclist signals being installed at a junction;
  - (c) SHALL be provided where pedestrian signals are installed at junctions or crossings; and
  - (d) SHALL NOT be provided when PEDESTRIAN PROHIBITED R218 signs have been posted.
- 3 Pedestrian crossing lines not only mark crossing positions for pedestrians, but can serve to improve the visibility of the junction and to assist drivers in recognising and identifying a junction as being signal controlled.

### 5.5.3 Regulatory road markings

- 1 The RTM1 STOP LINE imposes a mandatory requirement upon drivers of vehicles, when combined with a red light signal, that they shall stop their vehicles immediately behind such line.
- 2 The RTM2 YIELD LINE imposes a mandatory requirement upon drivers of vehicles that they shall yield right of way at the point marked by the line to all traffic, including pedestrians.
- 3 The RTM3 PEDESTRIAN CROSSING LINE imposes a mandatory requirement that drivers of vehicles shall yield right of way to a pedestrian who is crossing the roadway (or to a pedestrian waiting to cross the roadway), provided that pedestrians are crossing in accordance with the traffic light signals. It also imposes a mandatory requirement that pedestrians shall only cross the roadway within the area demarcated by the markings.
- 4 The RTM4 BLOCK PEDESTRIAN CROSSING imposes a mandatory requirement similar to that of the RTM3 pedestrian crossing line.
- 5 The RM1 NO-OVERTAKING LINE imposes a mandatory requirement that drivers of vehicles shall not drive on the right side of the line, or that any part of a vehicle crosses the line (except when the vehicle must gain direct access to any adjacent property, or to pass a stationary obstruction). At a junction or crossing, no-overtaking lines are used between two opposing directions of travel.
- 6 The RM3 CHANNELISING (STACKING) LINE imposes the mandatory requirement that drivers shall not drive a vehicle in such a manner that it, or any part of it, crosses such a marking. These lines are used between lanes of vehicles travelling in the same direction. The channelising line should be preceded by EXTRA DENSITY GM1 LANE LINES.
- 7 The RM4.1 LEFT EDGE LINE (YELLOW) is used to demarcate the left-hand edge of the travel way.
- 8 The RM4.2 RIGHT EDGE LINE (WHITE) is used to demarcate the right-hand edge of a travel way.
- 9 The RM5 PAINTED ISLAND MARKING imposes the mandatory requirement that drivers shall not drive a vehicle in such a manner that it, or any part of it, crosses such a marking.
- 10 The RM8 MANDATORY DIRECTION ARROWS (YELLOW) impose a mandatory requirement that drivers of vehicles may proceed only in the direction indicated by the arrows. The arrows SHALL be preceded by at least one and preferably two direction arrow ahead WM7 markings. The arrows may NOT be used to indicate an increase in the number of lanes ahead – BIFURCATION ARROWS GM3 must be used for this purpose.
- 11 The RM10 BOX JUNCTION marking imposes a mandatory requirement that drivers of vehicles shall not enter the box marked area within a junction if they are not able to leave such area due to stationary vehicles ahead of them.
- 12 The RM11 ZIG ZAG ZONE LINE imposes a mandatory requirement that drivers shall not park or stop in the area marked by the line except to yield right of way to pedestrians on a pedestrian crossing.
- 13 The RM12 NO-STOPPING LINE (RED) imposes a mandatory requirement that drivers of vehicles shall not stop their vehicles adjacent to such line (except in compliance to a regulatory sign or traffic signal).

### 5.5.4 Warning road markings

- 1 The WM2 CONTINUITY LINE is used to warn drivers that if they drive to the left (or right) of such line that they will shortly deviate from the through roadway.
- 2 The WM3 DIVIDING LINE is used to warn drivers that vehicles travelling on the other side of the line are travelling in the opposite direction (and if they wish to cross such line, they must wait until it is safe to do so).
- 3 The WM5 YIELD CONTROL AHEAD is a triangular shaped road marking used to warn drivers of a YIELD sign R2 ahead.
- 4 The WM6 LANE REDUCTION ARROWS are used to warn drivers that a lane on a multi-lane road ends some distance ahead, either from the left or the right, or from both left and right. The markings should be repeated at least once, but preferably three times, as shown in Figure 5.2.
- 5 The WM7 MANDATORY DIRECTION ARROW AHEAD warning markings are used to warn drivers that a MANDATORY DIRECTION ARROW marking RM8 is ahead which will require the driver to proceed only in the direction indicated by the arrow. At least one WM7 arrow shall precede an RM8 arrow marking (except when the RM8 arrow is in a recessed turn lane that is less than 25 m in length). The arrows may NOT be used to indicate an increase in the number of lanes ahead – BIFURCATION ARROWS GM3 must be used for this purpose.

### 5.5.5 Guidance road markings

- 1 The GM1 LANE LINES are used to demarcate traffic lanes for vehicles travelling in the SAME direction. STANDARD DENSITY LANE LINES are normally used on road links. At junctions, EXTRA DENSITY LANE lines should precede CHANNELISING (STACKING) LINES over a distance of at least 18 m (24 m in rural areas).
- 2 The GM2 GUIDE LINES are used to provide guidance through a junction. The lines may also be used to provide guidance to pedestrians when a formal pedestrian crossing is not warranted. YIELD LINES RTM2 may be incorporated to advise drivers of the likely need to yield within a turning movement.
- 3 The GM3 BIFURCATION ARROWS are used to indicate an increase in the number of lanes ahead. Mandatory direction arrows WM7 may not be used for this purpose.
- 4 The GM4 INFORMATION ARROWS are used to indicate the direction of travel permitted in a particular lane. The arrows can be useful at very wide junctions to indicate exit paths. The arrows can also be useful to indicate the exit direction of one-way streets at junctions.

| <b>Table 5.1: SUMMARY OF ROAD MARKINGS FOR SIGNALISED JUNCTIONS AND CROSSINGS</b>                                    |                                 |  |  |                                     |   |
|--|---------------------------------|--|--|-------------------------------------|---|
| <b>Marking number</b>  | <b>Description</b>              | <b>Urban areas</b>   |  | <b>Rural areas</b>                  |   |
|  |                                 | <b>Width</b>   | <b>Length</b>                                    | <b>Width</b>                        | <b>Length</b>                                     |
| <b>Regulatory road markings</b>  |                                 |  |  |                                     |   |
| RTM1 (white)<br>[1,2]  | STOP Line                       | 300 mm Min   | Full approach                                    | 500 mm Min                          | Full approach                                     |
| RTM2 (white)<br>[1,3]  | YIELD line                      | 300 mm Min   | 600 mm Line<br>300 mm Gap                        | 500 mm Min                          | 1000 mm Line<br>500 mm Gap                        |
| RTM3 (white)<br>[2,3]  | Pedestrian crossing line        | 100 mm Min<br>[4]  | Full roadway                                     | 100 mm Min<br>[4]                   | Full roadway                                      |
| RTM4 (white)   | Block pedestrian crossing       | [4]  | 600 mm Block<br>600 mm Gap                       | [4]                                 | 600 mm Block<br>600 mm Gap                        |
| RM1 (white)  | No-overtaking line              | 100 mm Min   | 9 m Minimum<br>18 m Preferred<br>27 m Multi-lane | 100 mm Min                          | 12 m Minimum<br>24 to 60 m Preferred              |
| RM3 (white)  | Channelising/<br>Stacking line  | 100 mm Min<br>Same as<br>GM1 or WM2  | 9 m Minimum<br>18 m Preferred<br>27 m Multi-lane | 100 mm Min<br>Same as<br>GM1 or WM2 | 12 m Minimum<br>24 m Preferred<br>60 m High speed |
| RM4.1<br>(yellow)  | Left edge line                  | 100 mm Min   |  | 100 mm Min                          |   |
| RM4.2 (white)  | Right edge line                 | 100 mm Min   |  | 100 mm Min                          |   |
| RM5 (yellow<br>with white<br>borders)  | Painted island marking          | 100 mm White boundary lines<br>150 mm to 1 000 mm Yellow lines sloped at 30/60 degrees<br>or 200 mm to 600 mm Continuous yellow line between two white lines |  |                                     |   |
| RM8 (yellow)   | Mandatory direction arrows      | Approximately 1 m in advance of stop line.   |  |                                     |   |
| RM10<br>(yellow)   | Box junction                    | 100 mm Min   |  | 100 mm Min                          |   |
| RM11 (white)   | Zig Zag Zone                    | 100 mm Min   | 2,0 m Line<br>150 mm Gap<br>30 m length          | 100 mm Min                          | 2,0 m Line<br>150 mm Gap<br>30 m length           |
| RM12 (red)   | No-stopping line                | 100/150 mm Min   |  | 100/150 mm Min                      |   |
| <b>Warning road markings</b>   |                                 |  |  |                                     |   |
| WM2 (white)<br>[5]   | Continuity line                 | 200 mm Min   | 1,5 m Line<br>1,5/3,0/7,5m gap                   | 200 mm Min                          | 2 m Line<br>2/4/6 m Gap                           |
| WM3 (white)  | Dividing line                   | 100 mm Min   | 3,0 m Line<br>6,0 m Gap                          | 100 mm Min                          | 4,0 m Line<br>8,0 m Gap                           |
| WM5 (white)  | Yield control ahead             |  |  |                                     |   |
| WM6 (white)  | Lane reduction arrows           |  |  |                                     |   |
| WM7 (white)  | Mandatory direction arrow ahead |  |  |                                     |   |
| <b>Guidance road markings</b>  |                                 |  |  |                                     |   |
| GM1 (white)<br>[5]   | Lane lines                      | 100 mm Min   | 1,5 m Line<br>1,5/3,0/7,5m gap                   | 100 mm Min                          | 2 m Line<br>2/4/6 m Gap                           |
| GM2 (white)  | Guide lines                     | 100 mm Min   | 0,5 m Line<br>1,5 m Gap                          | 100 mm Min                          | 0,5 m Line<br>1,5 m Gap                           |
| GM3 (white)  | Bifurcation arrows              |  |  |                                     |   |
| GM4 (white)  | Information arrows              |  |  |                                     |   |
| <b>NOTES</b>   |                                 |  |  |                                     |   |
| [1] Stop line not less than 1,2 m and not more than 15 m in advance of continuation of edge of the crossing roadway. |                                 |  |  |                                     |   |
| [2] Stop line minimum 1,0 m in advance of pedestrian crossing lines (3,0 m at pedestrian crossings).                 |                                 |  |  |                                     |   |
| [3] Yield line minimum 3,0 m in advance of pedestrian crossing lines minimum (preferably 6,0 m).                     |                                 |  |  |                                     |   |
| [4] Pedestrian crossing width – 2,4 m Minimum; 3,0 m Preferred minimum; 5,0 m Preferred maximum.                     |                                 |  |  |                                     |   |
| [5] Continuity and Lane lines available as extra, standard and reduced density lines, depending on gap size.         |                                 |  |  |                                     |   |

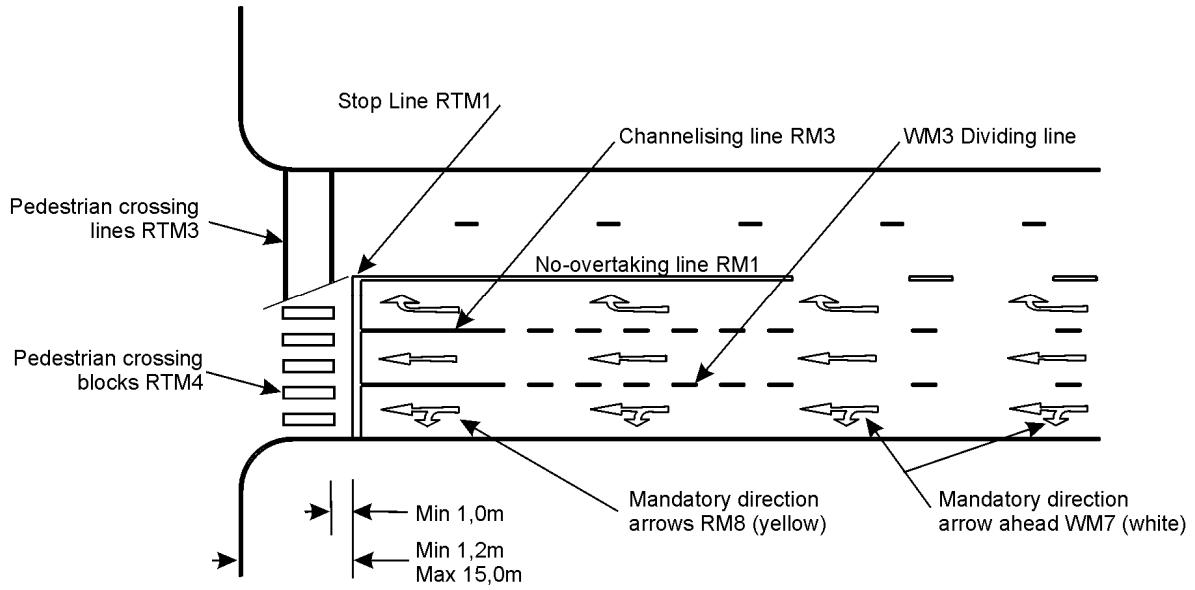

Figure 5.7: Road junction with pedestrian crossing markings

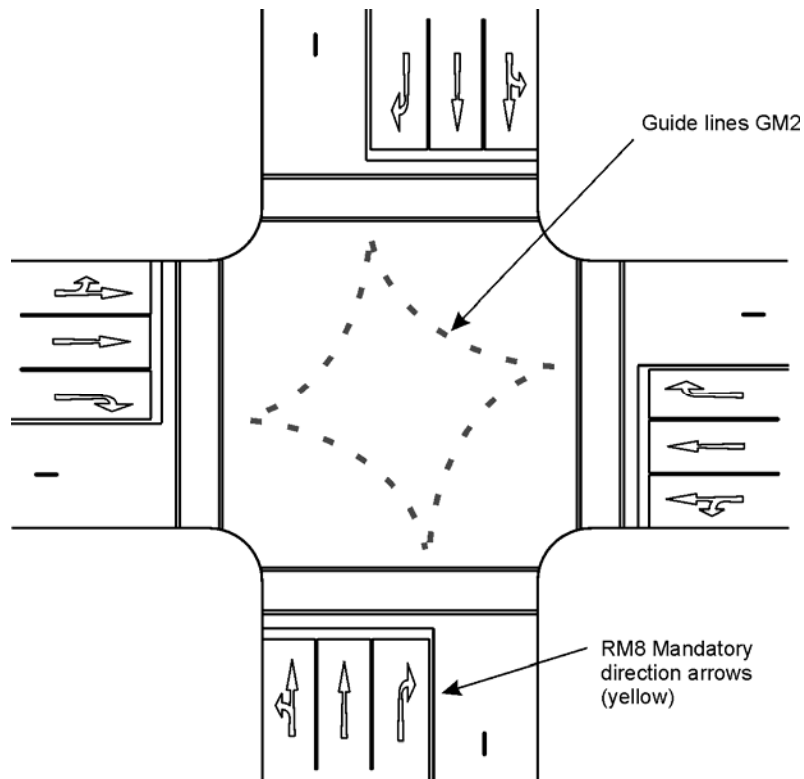

Figure 5.8: Guide lines through a junction

## 5.6 ROAD LIGHTING

- 1 The provision of road lighting at signalised junctions and mid-block pedestrian crossings will promote safe operations at night. Adequate lighting will contribute to increased visibility, thereby increasing driver awareness of the signals as well as possible conflicts within the junction. Lighting enhances traffic safety by illuminating hazardous objects or situations so that the driver can respond readily and safely.
- 2 Lighting can reduce the number of accidents at night to about a third of that occurring during the day. Reduction factors such as this can be used in cost-benefit analyses in which the benefits accruing from lighting can be compared with the cost of providing such lighting.
- 3 In addition to its safety benefits, the provision of road lighting can also contribute to reducing crime levels.
- 4 At junctions, road lighting is particularly justified when a significant number of pedestrians cross the junction or crossing at night. Such junctions would normally be located near developments that have a large component of recreational land use. This includes sporting venues, cinemas, popular restaurants, resorts, etc.
- 5 Lighting is also required at complex junctions with islands and other obstructions, or where significant volumes of vehicles turn right at night.
- 6 An important principle in the provision of road lighting is that a uniform level of brightness should be provided over the full junction or crossing. Drivers may not discern objects when brightness is allowed to vary. Care should also be taken to ensure that all important features are illuminated, including kerbs and pedestrian crossings.
- 7 A further important aspect related to the introduction of lighting at remotely located junctions, is the time required by drivers to visually adapt to changes in lighting levels. The problem mainly occurs when drivers leave the illuminated area. To address this problem, the level of lighting at the junction should be kept relatively low. Alternatively, the level of lighting can be gradually reduced.
- 8 High mast lighting is often used at remotely located junctions. This method of lighting has several advantages. These include the following:
  - (a) High mast lighting covers a greater area of the junction, including areas adjacent to the roadway. Drivers can therefore relate to the entire junction complex.
  - (b) Fewer poles located farther away from the edge of the pavement reduce the probability of collisions with the poles.
  - (c) Transition lighting is more easily achieved because of the gradual reduction of light levels at higher mounting heights.

The disadvantage of high mast lighting is that additional energy is required to illuminate areas other than the roadway itself.

## 5.7 BIBLIOGRAPHY

- 1 AUSTRROADS, 1988, Part 5- Intersections at Grade, Australia.
- 2 AASHTO (American Association of State Highway and Transportation Officials), 1995, A policy on Geometric Design of Highways and Streets, Washington, USA.
- 3 Committee of Urban Transport Authorities, 1986, UTG1 Guidelines for the geometric design of urban arterial roads, Pretoria,
- 4 Committee of Urban Transport Authorities, 1989, UTG7 Geometric design of urban local residential streets, Pretoria,
- 5 Committee of Urban Transport Authorities, 1988, UTG5 Geometric design of urban collector roads, Pretoria,
- 6 Committee of Urban Transport Authorities, 1990, UTG10 Guidelines for the geometric design of commercial and industrial local streets, Pretoria,
- 7 Committee of State Road Authorities, 1988, TRH 17, Geometric design of rural roads, Pretoria,



## CHAPTER 6: SIGNAL TIMING AND PHASING

### 6.1 INTRODUCTION

- 1 Correct timing and phasing are fundamental to the proper functioning of traffic signals. Wrong signal settings can lead to wastage of time and fuel by road users and drivers taking risks, leading to a greater risk of collisions. Managing the effective operation of signals depends upon careful planning and the implementation of an effective programme of data collection and analysis/calculation.
- 2 The timing methods described herein apply to signals operating in fixed time mode, but some of these methods can be extended to other modes of control, perhaps with some modification. These other modes of control include vehicle-actuated and traffic responsive control. Additional information on these modes of control is given in other chapters of this manual.
- 3 In fixed time control, the sequence and duration of each light signal is predetermined and can only be changed by changing the controller settings. Different timing plans, however, can be operated at different times of the day, and days of the week, with suitable controllers.

### 6.2 TIMING PARAMETERS

- 1 The establishment of traffic signal settings involves the setting of signal phases and the timing of parameters such as the cycle length, green splits, yellow and all-red intervals and co-ordination offsets.
- 2 The concept of signal timing is best thought of as intervals of a cycle time during which different light signals are given to the different streams of traffic. An example of such signal intervals is shown in Figure 6.1. This figure shows the intervals during which green, yellow and red light signals are displayed on two intersecting roads.
- 3 A number of important timing parameters are shown in Figure 6.1. The following are definitions of these parameters:
  - (a) **Cycle:** The time required for one complete sequence of light signals.
  - (b) **Intergreen:** The yellow signal interval plus the all-red interval. This is the safety period between the end of one green light signal and the start of another green light signal that gives right of way to a conflicting traffic stream. This period is also called the *interstage* interval.
  - (c) **Offset:** The time difference between the start of a signal stage at one traffic signal relative to the start of a stage at another signal, or relative to some system time base. Offsets are sometimes also measured at the start of an interstage interval.
  - (d) **Phase:** An interval of the signal cycle during which a particular green signal is displayed. The phase starts when the particular green signal is first displayed and ends as soon as this same green signal is terminated.

- (e) **Stage:** An interval of the signal cycle during which any combination of vehicular green signals is displayed (pedestrian or pedal cyclist green signals excluded). A stage starts when any vehicular green signal is first displayed and ends as soon as any of the vehicular green signals being displayed are terminated.
  - (f) **Signal group:** A group of traffic signal faces that always display *exactly* the same sequence of light signals at the same time. These signal faces are electrically interconnected and can therefore not display different signals at any time.
- 4 Figure 6.1 shows an example of a three-stage traffic signal with six signal groups. The following signal groups are provided:
    - (a) North/South street – all turning movements.
    - (b) East approach - protected-only right-turn.
    - (c) East approach – left-turn and straight-through movements.
    - (d) West approach – all turning movements.
    - (e) North/South pedestrian signal.
    - (f) East/West pedestrian signal.
  - 5 The three stages in Figure 6.1 are as follows:
    - (a) Stage 1 during which green is given to the N/S street and N/S pedestrians.
    - (b) Stage 2 during which green is given for the protected-only right-turn phase on the east approach.
    - (c) Stage 3 during which green is given for the E/W street and E/W pedestrians.
  - 6 A number of signal phases are also shown in the figure:
    - (a) The North/South main phase.
    - (b) The East approach right-turn phase.
    - (c) The North/South pedestrian phase.
    - (d) The East/West pedestrian phase.

### 6.3 DEFINITION OF PHASES

- 1 The definition of the term **phase** used in this manual differs from that used in most other publications. Professionals involved with traffic signal design should be aware that, in addition to the definition used in this manual, there are (at least) two other definitions for the term. These definitions are as follows:
  - (a) In the one definition, a phase is defined as the sequence of light signals applicable to one or more streams of traffic that always receive identical indications (equivalent to the above definition of a **signal group** or a **SABS phase**).
  - (b) In the second definition, a phase is defined as an interval of time during which one or more traffic streams simultaneously receive right of way (equivalent to the above definition of a **stage**).

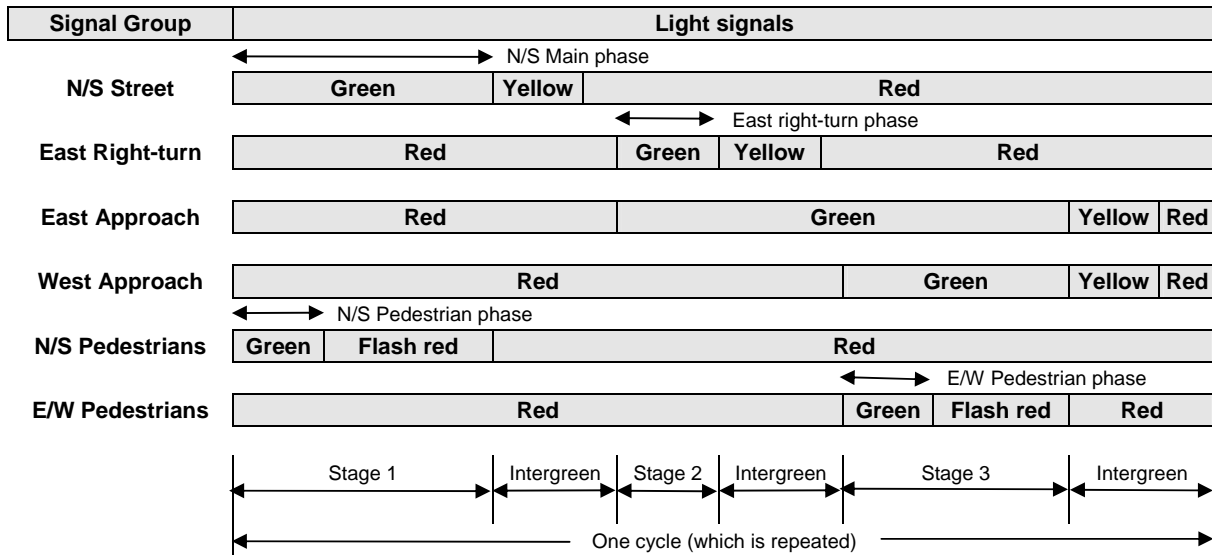

Figure 6.1: Example of signal intervals for a three-stage traffic signal with six signal groups

- The first definition is used in South African standard specification SANS 1547: *Traffic signal controllers* as well as most, if not all, traffic signal configuration programs used in South Africa. The second definition, on the other hand, is used in many international traffic engineering manuals and handbooks. This has led to considerable confusion in South Africa.
- To address the above problem, the use of the term phase in this manual is restricted to situations where the meaning of the term is generally well understood. The term is generally used as a replacement for the term “green light signal”, as shown in Figure 6.1.
- In this manual, the term “signal group” is used as an equivalent for the first definition for phase given above, and the term “stage” is used instead of the second definition. This corresponds with the approach followed in the SANS specifications, except that the term “signal group” is used instead of “phase”. In a number of situations, the term “signal group” will be augmented by the phrase **[SANS phase]** to ensure that there is no misunderstanding of terms.
- It is important to realise that traffic flow patterns may change after the commissioning of a new traffic signal. It will often be necessary to adapt traffic signal timings, and even phasing, after the system has settled down.
- Data collection plays a particularly important part in the management of fixed time signal settings. Signal phasing and timing should be based upon the best available data at any given time. There should therefore be a structured programme for data collection, from the planning and design stage, through implementation, to the subsequent on-going maintenance and support.
- It is important to note that traffic counts at existing traffic signals under congested or saturated conditions should be treated with care since they will not give a true indication of demand due to overflow queuing. Stop line traffic counts in such circumstances could indicate that the current settings are adequate, while this might not be the case. Traffic counts must then be adjusted to account for queues that form on the road network.
- Updating may involve changes to the signal timings as well as signal phases. Most often, it is the signal timings that will need updating. Phasing requirements – such as the need for new right-turn phases - will change less often. Physical changes to the road network may have a marked impact on phasing requirements.

#### 6.4 MANAGING SIGNAL SETTINGS

- Signal settings need to be reviewed periodically in the light of possible changes in traffic demand or changes to the road network. In situations where the road network does not change and traffic patterns do not vary significantly (such as in a busy central business district), frequent updating of signal timings will not be necessary. On the other hand, in situations where traffic is growing or the road network is changing, new settings may have to be revised at intervals as short as 12 months. This requires an awareness of what is happening on the roads in an area.

## 6.5 SIGNAL TIMING PLANS

- 1 Traffic signals often require the use of multiple timing plans to cope with the variation in traffic demand throughout the day, and on different days of the week. This is particularly important when fixed time traffic signal systems are used.
- 2 A timing plan determines the cycle time, the sequence of phases and stages, and the timing characteristics of each stage. It may also determine the mode of operation at a particular time, where the controller is capable of operating under different control modes.
- 3 Any given plan may be brought into operation during any selected period of the day, or day of the week, according to a predetermined timetable, or "programme". By changing the plan, the signal settings can thus be changed to suit the traffic conditions at a particular time.
- 4 A single timing plan may be adequate when traffic volumes are generally low, but then the signals are probably not warranted in the first place (or traffic volumes may fluctuate equally on each approach at the same time). Most signals would usually require more than one signal timing plan.
- 5 The following traffic signal plans would typically be provided at a typical signal location:
  - (a) Weekday morning (AM) peak period plan, typically operated for a period of 30 minutes before and 30 minutes after the morning peak period.
  - (b) Off-peak (midday) period, operating between the morning and afternoon peak plans.
  - (c) Weekday afternoon (PM) peak period plan, typically operated for a period of 30 minutes before and 30 minutes after the afternoon peak period.
  - (d) Evening period (following the PM peak period).
  - (e) Night (low-flow) period.
  - (f) Weekend and holiday periods.
- 6 Near shopping centres, high traffic volumes may be experienced on weekends. It may then also be required to implement the following additional timing plans:
  - (a) Friday afternoon (PM) peak period plan.
  - (b) Saturday peak period plan.
- 7 A special Sunday peak period plan may also be required near holiday resorts and at shopping centres which are open on Sundays.
- 8 At schools, a midday plan may be required to accommodate a local peak in traffic volumes.
- 9 In large cities, there may also be a need to subdivide peak periods into smaller sub-periods to cope with different demand patterns that may occur due to different trip purposes.
- 10 At some locations, a development (e.g. a hospital or a factory) that generates large volumes of traffic may also create a specific peak period associated with the opening and closing times (or visiting hours) of the development.

- 11 Traffic operations can be improved by providing a variety of timing plans that can cope with variations in traffic demand. Care should, however, be taken not to change plans too often, since plan changes involve transitions which are often inefficient and which could seriously disrupt traffic flow and signal operations.

## 6.6 TRAFFIC COUNTS

### 6.6.1 General

- 1 Traffic counts are required for establishing optimal settings and phasing of a traffic signal. Each timing plan would require a set of traffic counts taken over a specific design period.
- 2 Design periods may be known for a particular area or can be determined based on a general knowledge of traffic flow patterns in the area. Where such information is not available, design periods can be identified by means of automatic 24-hour traffic counts taken on a few representative roads or streets over a period of seven days or longer. In order to establish traffic patterns, it is not necessary to count traffic on each approach to each signal, or to count each individual turning movement. The selected roads or streets must, however, be representative of the traffic patterns in the network.
- 3 Detailed traffic counts are required for each design period for which traffic signal settings and phases are to be established. These counts are taken manually, and each turning movement is counted separately. If there are significant numbers of heavy vehicles and/or buses (more than 5 or 10% of the traffic), classified counts may be taken. The counts are enumerated in 15-minute intervals.
- 4 A lane utilisation study may also be required at locations where drivers tend to avoid using particular lanes. Such a study will establish the proportion of vehicles using the heaviest loaded lane. This study will generally be undertaken for straight-through movements, but where more than one lane is provided for a left- or right-turn movement, the study may also be required for the turning movements.

### 6.6.2 Congested conditions

- 1 It is important to realise that a traffic count is not necessarily an indication of traffic demand. A low traffic volume could indicate congested conditions rather than a low demand. If this occurs, queues of vehicles at the traffic signal(s) can be observed and the traffic counts adjusted for changes in the queue lengths. These queues may be forming at the signal(s) being investigated or at other upstream bottlenecks in the system. In such cases, the traffic demand is estimated at such bottlenecks and projected through the road network.
- 2 A procedure for adjusting traffic counts by means of queue length observations is described in Chapter 29. It should be noted that the adjustments could still probably under- or overestimate actual traffic demand due to traffic diverting to other routes in the network.

### 6.6.3 Normal and exceptional days

- 1 An important consideration when traffic is counted, is the concept of normal and exceptional days. Fixed time traffic signal timings are established for the normal days of the week in a year, and not those days on which traffic volumes are either exceptionally high or low. Normal days occur more often than exceptional days, and signal timings established for such days would generally result in more efficient operations compared to timings established for days that occur less often in a year.
- 2 **It is important that care should be taken to ensure that traffic is counted only on normal days and not on exceptional days.** More details on normal and exceptional days are given in Chapter 29.

### 6.6.4 Predicting traffic volumes

- 1 It is obviously not possible to count traffic on a road that is still being planned and that has not yet been constructed. The installation of new traffic signals at a junction could also attract additional traffic to the junction because of the greater accessibility provided by the signals. In such cases, future traffic volumes must be estimated.
- 2 Specialised techniques are used to predict changes in traffic volumes, and these are not covered. Such techniques may involve the utilisation of computer models, or it may involve a simple consideration of traffic patterns in an area.
- 3 It is often difficult to predict changes in traffic volumes sufficiently accurate to set traffic signals, and it is therefore preferable to recount traffic volumes once the changes have been implemented and traffic patterns have settled. Traffic signal settings can be changed relatively easily, and it is therefore not necessary to predict traffic too far ahead into the future.

## 6.7 SIGNAL PHASES

- 1 Determining the phasing requirements of a traffic signal is an important aspect of establishing traffic signal settings.
- 2 Examples of signal phases that can be provided at a traffic signal are shown in Figure 6.2. The following phases are shown in the figure:
  - (a) The main phase, which provides for straight-through and permitted left and right-turn movements, and which is signalled by a steady green light signal. A parallel pedestrian or pedal cyclist phase is also provided.
  - (b) Single right-turn phase which provides for a movement to the right, with or without a parallel left-turn phase which provides for a movement to the left. Both phases are signalled by flashing green arrow light signals. A parallel pedestrian or pedal cyclist phase is also provided, but only on the one side of the road.
  - (c) Double right-turn phase which provides for right-turn movements from two approaches, with or without left-turn phases from two adjacent directions. All phases are signalled by flashing left green arrow light signals.

- 3 A protected turning phase that allows one movement direction to turn while another movement on the same approach is stopped, should preferably only be used if separate exclusive lanes are provided for each of the movements. For instance, a right-turn phase, which allows right-turn vehicles to turn while straight-vehicles are stopped, should only be used when a separate right-turn lane is provided.

## 6.8 MAIN SIGNAL PHASES

- 1 The main signal phase can be provided for straight-through and permitted left and right-turn movements. Such a phase is signalled by a S1 traffic signal face.
- 2 **Particular care must be taken when terminating a main phase during which a right-turn movement was permitted. The following are of importance:**
  - (a) **A phase during which right-turn traffic is permitted to turn shall NOT be terminated early while a green light signal is displayed to traffic on the conflicting opposing approach. The right-turn traffic may not be aware that the opposing traffic is still receiving green, and may then turn into the face of oncoming traffic, which could be dangerous.**
  - (b) **When a protected left-turn phase is introduced on the opposing approach immediately following a main signal phase, an all-red period of sufficient duration should be given to allow right-turning vehicles to clear the junction before the onset of the protected left-turn phase.**

## 6.9 LEFT-TURN SIGNAL PHASES

- 1 The left-turn signal phase is provided for left-turning vehicles only, and is allowed by a flashing green left arrow light signal (or the flashing tram and bus light signals).
- 2 The basic sequence of green, yellow and red (where provided) light signals shall normally be displayed when a left-turn phase is provided. However, on the S9 and S10L signal faces, the yellow arrow light signal may be omitted from the sequence subject to the conditions that (as stated in Chapter 3):
  - (a) the flashing green arrow light signal must immediately be followed by a steady green light signal which allows the left-turn movement to turn; and
  - (b) when pedestrian or pedal cyclist signals are provided, no green pedestrian or pedal cyclist light signal may be displayed following the flashing green arrow light signal. The yellow arrow light signal shall NOT be omitted when such green pedestrian or pedal cyclist light signal is displayed.

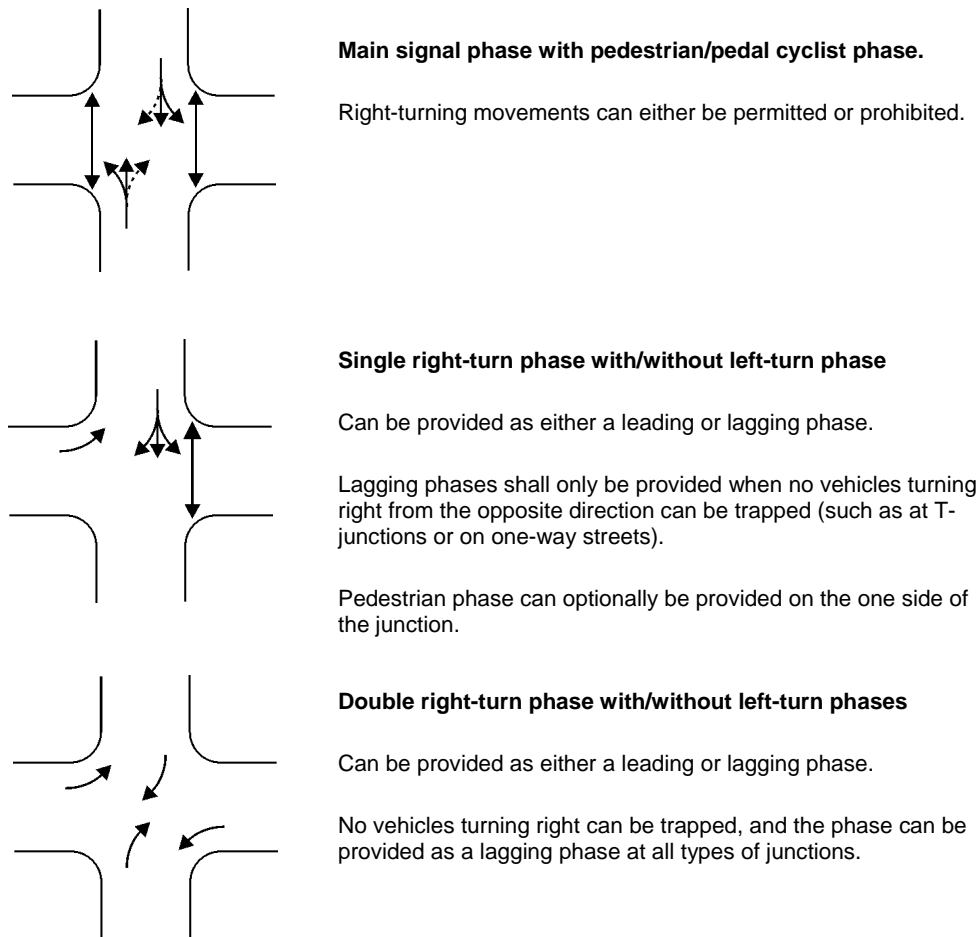

**Figure 6.2: Various types of traffic signal phases at a signalised junction**

- 3 The left-turn phase is used to indicate to drivers of vehicles that their turning movements are unopposed by any conflicting vehicular, pedestrian and pedal cyclist traffic movements. The phase may therefore not be provided when there are any such conflicting movements. The following are particularly important examples of such movements:
  - (a) Pedestrians movements (the left-turn phase may not be provided at the same time as a parallel pedestrian phase).
  - (b) Right-turning traffic from the opposite approach.
- 4 A left-turn phase will usually be a parallel phase, i.e. it runs at the same time as another non-conflicting phase. It often runs parallel with a right-turn phase on the crossing approach from the left of the junction (or the side road at a T-junction).
- 5 When a protected left-turn phase is introduced immediately following a main phase, an all-red period of sufficient duration is required to allow opposing right-turning traffic from the opposite direction to clear the junction. The onset of the left-turn phase can be delayed by a short period of time to provide the additional clearance time.

## 6.10 RIGHT-TURN SIGNAL PHASES

### 6.10.1 Signalling right-turn phases

- 1 The right-turn signal phase is provided for right-turn vehicles only, and is allowed by a flashing green right arrow light signal (as well as the flashing tram and bus light signals).
- 2 The right-turn phase is used to indicate to drivers of vehicles that their turning movements are unopposed by any conflicting traffic movements. This phase may therefore not be provided when there are any conflicting traffic movements. An important example of such conflicting traffic movements is pedestrians.
- 3 The pedestrian phase may be provided in parallel with the main or other suitable phase that serves the same approach as the right-turn phase. There is, however, an exception to this, worth considering: the pedestrian crossing in question can be eliminated altogether and a pedestrian prohibited sign R218 posted. In this case, pedestrians would cross the other approaches to get to the other side of the right-turn exit - this would entail an extra road crossing and may not be acceptable to pedestrians.

- 4 A right-turn phase can be provided in one of two modes of operation, namely protected/permitted and protected-only modes:
  - (a) In **protected/permitted mode**, a leading or lagging protected turn phase is provided, but the turning movement is also permitted during the main phase.
  - (b) In **protected-only mode**, vehicles are only allowed to turn during a leading or lagging protected phase.
- 5 For this reason, the lagging right-turn phase is NOT allowed unless:
  - (a) there is no right-turning traffic in the opposite direction (as a T-junction or on one-way streets).
  - (b) double lagging right-turn phases are provided on both approaches.
- 6 Apart from the situation where a single lagging right-turn phase is not allowed, both types of right-turn phases have advantages and disadvantages:
  - (a) The leading right-turn phase has the important advantage, particularly on high-speed roads, that vehicles will only turn when opposing traffic has been at rest for some time. When a lagging phase is provided, vehicles will turn while opposing traffic is in the process of stopping.
  - (b) The leading green also has the advantage that it could reduce the number of gap acceptance conflicts, which may lead to safer operations. With lagging green, more vehicles may accept gaps while waiting for the right-turn phase.
  - (c) The leading green, however, has the disadvantage that it may be creating a habit in which drivers turning right tend to pre-empt right of way, even when no right-turn phase is provided. The lagging phase has the advantage that normal signal operations and normal driving behaviour are better approximated.
  - (d) A second disadvantage of the leading green is the tendency for false starts on the opposite approach. It is not a rare occurrence to find vehicles on the opposite approach pulling away at the same time as traffic receiving the leading green.
  - (e) An advantage of the lagging right-turn phase is that it provides significantly better separation between right-turning vehicles and pedestrians. This is a particularly important advantage in areas with high pedestrian volumes.
  - (f) A further advantage of the lagging right-turn phase is that it can be more efficient when vehicle-actuated control is implemented. The lagging phase is only called at the end of the main phase if right-turning vehicles remain that could not accept gaps. With leading green, the phase will be called independent of whether right-turning vehicles will be able to accept gaps.
- 7 No absolute advantages are inherent in either leading or lagging configurations. The choice of the optimum configuration will be dictated by specific conditions at a particular junction.

### 6.10.2 Single and double right-turn phases

- 1 Leading and lagging right-turn phases can be provided as single or double right-turn phases.
- 2 The **single** right-turn phase protects only one right-turn movement on one axis of a junction. Straight-through and left-turn traffic also receives right of way during the phase, and all traffic on the opposite approach must stop.
- 3 An important advantage of the single right-turn phase is that it allows sharing of lanes by different turning movements, such as by straight-through and right-turn movements. This is an advantage on approaches where it is not possible to provide separate right-turn lanes. This advantage, however, will only be realised when traffic volumes on the opposing approach are relatively low.
- 4 The **double** right-turn phase protects both right-turn movements on one axis of a junction. The two right-turning movements receive flashing green light signals at the same time. No straight-through or left-turning traffic on this axis receives right of way during this time.
- 5 The double right-turn phase has the disadvantage that the flashing green right arrow light signals are sometimes not noticed by drivers. This problem can to some extent be addressed by providing additional signal faces that contain the flashing green arrow signals.

### 6.10.3 Leading and lagging right-turn phases

- 1 Right-turn phases can be provided as leading or lagging right-turn phases.
- 2 The **leading** right-turn phase, also sometimes referred to as a "late release", appears with or before the main phase on the same approach.
- 3 The **lagging** right-turn phase, also sometimes referred to as an "early cut-off", appears after or during the final part of the main phase interval.
- 4 The **single lagging right-turn phase** has one particular important problem that limits its application. This phase is introduced by terminating the main phase early in the opposite direction. This can result in a situation where a yellow light signal is displayed to right-turning traffic while conflicting traffic movements receive a green light signal - a combination of light signals which is not allowed. In this situation, the right-turning traffic receiving yellow may not know that opposing traffic is still receiving green, and may turn right into the face of this oncoming traffic, which could be dangerous.

## 6.11 WARRANTS FOR RIGHT-TURN SIGNAL PHASES

### 6.11.1 General

- 1 The decision to install a right-turn phase at a junction is one of the most important decisions when determining phasing requirements at signals.
- 2 Although a separate right-turn phase can improve the right-turn movement, unwarranted right-turn phases can be wasteful and can lead to deterioration of the capacity of a traffic signal. A right-turn phase wastes a valuable part of the cycle time, which cannot be used by other conflicting movements. It is unacceptable to operate a right-turn phase to the detriment of the main traffic movements through the junction, so that the right-turning traffic has an inequitably high level of service in relation to the main traffic movements, some of which may be of much greater importance in the road system, e.g. the co-ordinated through traffic on an arterial.
- 3 It is highly unlikely that a right-turn phase will be justified for 24 hours a day or on every day of the week. Right-turn phases are usually necessary only during peak periods. A right-turn phase should therefore be considered only where a separate peak-period signal timing plan can be run, during which the right-turn phase can appear, when it is needed. It should NOT be included in another signal plan when it is not justified, e.g. the off-peak or night plans.
- 4 The motivation for a right-turn phase will generally be based upon safety and operational considerations.

### 6.11.2 Safety considerations

- 1 A right-turn phase justified by **safety** considerations would usually be operated in *protected-only* mode in which gap acceptance is not allowed, although a *protected/permitted* right-turn can also contribute towards an improvement in safety.
- 2 The safety considerations would include the following:
  - (a) Where accident experience indicates that turning traffic is unable to utilise sufficient safe gaps in which to turn.
  - (b) Where drivers turning right cannot properly see traffic approaching from the opposite direction, such as:
    - (i) When wide medians are provided and the offset of opposing turning lanes is such that the opposing turning vehicles restrict sight distances.
    - (ii) When the junction is located on a horizontal curve and the view of turning vehicles is blocked by turning vehicles on the opposite approach.
    - (iii) When two or more turning lanes are provided in such a way that the sight distance of vehicles on one lane will be blocked by vehicles in another lane.

- (c) Where conflicts occur between right-turning traffic and parallel pedestrian movements during the main signal phase. Such conflicts can be reduced by providing a protected-only right-turn phase and prohibiting the right-turn movement when the parallel pedestrian phase is provided.

### 6.11.3 Capacity considerations

- 1 A right-turn phase is justified on the basis of **capacity** (or operational) considerations when the volume of traffic wishing to turn right cannot do so because of the volume of opposing traffic and consequent lack of suitable gaps, resulting in long queues of right-turning vehicles. If safety considerations permit, the right-turn phase can be operated in *protected/permitted* mode.
- 2 Various methods are available for the motivation of right-turn phases based on *operational* considerations. Most of the methods require the use of a suitable model for the calculation of a level of service or a performance index, usually based on vehicular delay (and possibly number of stops). The junction is then modelled with and without the proposed right-turn phases, and the alternative with the best overall level of service is selected.
- 3 A manual method for establishing signal timings for fixed time signals is described later in this chapter. According to this method, a right-turn phase will be needed when the right-turn traffic cannot be handled at an acceptable degree of saturation without a right-turn phase. Typically, this would be found when right-turn volumes exceed about 100 to 150 vehicles per hour on an approach.

## 6.12 THE INTERGREEN PERIOD

### 6.12.1 General

- 1 The intergreen period is defined as the yellow plus the all-red or clearance period. This period is fundamentally important for the safe operation of a signal and is monitored by the controller apparatus.
- 2 The yellow period provides an indication that a red light signal will be displayed shortly, allowing the driver to stop if possible. The all-red (or clearance) period provides for a clearance time of the junction.
- 3 Ideally, a yellow period should give sufficient warning to allow drivers to stop safely, even under adverse weather conditions. When such a driver is too near the junction to stop safely, sufficient time should be provided for the driver to enter the junction on yellow, and to clear the junction during the all-red period.
- 4 The ideal requirements, however, can result in relatively long yellow periods. Drivers tend to abuse long yellow periods, using the yellow as effective green that can result in unsafe conditions. A more pragmatic approach is therefore recommended in which the yellow period is reduced and the all-red period correspondingly increased, while effectively providing the same intergreen period.
- 5 The reduced yellow period may result in drivers entering a junction during the all-red period being prosecuted unfairly. It is therefore recommended that an **enforcement tolerance** should be provided and that law enforcement should only commence during the last one second of the all-red interval.

### 6.12.2 Yellow interval

- 1 The following formula will provide a yellow period that would be adequate for an average driver driving through a junction under **dry** weather conditions:

$$\text{Yellow} = t_y + \frac{1}{2} \cdot \frac{V / 3,6}{A_y + g \cdot G / 100}$$

In which:

|       |   |   |
|-------|---|---|
| $A_y$ | = | deceleration rate, taken as 3,7 m/s <sup>2</sup>    |
| $V$   | = | speed limit or advisory speed (km/h)                |
| $t_y$ | = | reaction time, taken as 0,75 seconds                |
| $G$   | = | gradient on approach to signal(%)                   |
| $g$   | = | acceleration due to gravity (9,8 m/s <sup>2</sup> ) |

- 2 The above formula will allow a driver travelling at the speed limit, but who could not stop because he or she requires a deceleration rate greater than 3,7 m/s<sup>2</sup>, to continue travelling at the speed limit and reach the stop line just as the yellow interval terminates.
- 3 The use of very short yellow intervals could lead to dangerous driving conditions. The interval calculated by means of the above formula must therefore be subject to the following minimum values:

| Speed limit or Advisory speed | Minimum yellow (seconds) |
|-------------------------------|--------------------------|
| 60 km/h or less               | 3,0                      |
| 70 km/h                       | 3,5                      |
| 80 km/h                       | 4,0                      |

- 4 The yellow interval calculated by means of the above formula is NOT adequate for wet weather conditions or for drivers requiring a longer reaction time. To accommodate such drivers and weather conditions, a longer all-red period is provided which can effectively be used as an extension of the yellow period.
- 5 Practical values for the yellow interval calculated by means of the above formula, and taking the minimum values into account, are given in Table 6.1. The values given in the table will cover the range of conditions that occur most often in practice. Where different movements or approaches require different yellow intervals due to different approach speeds and gradients, the longest interval should be used.
- 6 The yellow intervals given in Table 6.1 for left and right-turn movements have been calculated for a speed of 35 km/h. Where the geometric design of a junction allows for faster turning movements, a higher approach speed may be selected.

### 6.12.3 All-red (clearance) interval

- 1 The following formula will provide an all-red interval that would be adequate to accommodate wet conditions or drivers requiring longer reaction times:

$$\text{All-red} = t_r + \frac{1}{2} \cdot \frac{V / 3,6}{A_r + g \cdot G / 100} + \frac{W}{V / 3,6} - \text{Yellow}$$

In which:

|       |   |   |
|-------|---|---|
| $A_r$ | = | deceleration rate, taken as 3,0 m/s <sup>2</sup>    |
| $V$   | = | speed limit or advisory speed (km/h)                |
| $t_r$ | = | reaction time, taken as 1,0 seconds                 |
| $G$   | = | gradient on approach to signal (%)                  |
| $g$   | = | acceleration due to gravity (9,8 m/s <sup>2</sup> ) |
| $W$   | = | Clearance width (metre)                             |

- 2 An all-red or clearance interval shorter than that calculated by the above formula, may be provided at the termination of a leading right-turn phase that is followed by a phase allowing straight-through or left-turn movements from the opposite approach. The possibility of conflicts during this interval is generally low because drivers on the opposite approach are generally more aware of the right-turning traffic, allowing the use of a shorter interval. **The duration of the required interval can be determined by subtracting one second from the above formula.**
- 3 The use of very short all-red intervals could lead to dangerous driving conditions. The interval calculated by means of the above formula must therefore be subject to the following minimum values:
  - (a) 1 Second between leading right-turn movement and straight-through or left-turn movements from the opposite approach.
  - (b) 2 Seconds for all other movements.
- 4 The clearance width  $W$  can be measured from the stop line to the continuation of the furthest edge of the crossing roadway at the exit side of the junction as shown in Figure 6.3. This is a relative simple, but safe method for calculating all-red periods and is recommended for general use.
- 5 The method of measuring clearance width  $W$  shown in Figure 6.3, could result in unnecessary long all-red intervals under specific circumstances. A more precise, but relatively complex method is to measure the clearance width from the stop line to the furthest side of conflicting movements that will receive green during a following phase. In many cases, this width would be shorter than the one to the exit side of the junction. The use of these shorter widths would therefore result in shorter all-red intervals. When using the method, however, specific care must be taken to ensure that a too short all-red period is not inadvertently given at the end of the signal phase.
- 6 Practical values of the all-red interval for a range of conditions that occur most often in practice are given in Table 6.1. The values have been calculated by means of the above formula (subject to minimum values). Where different approaches and turning movements require different all-red intervals, the longest interval should be used.



| Speed limit or advisory speed                                   | Approach gradient (*) | Yellow interval | Clearance and all-red intervals for clearance widths W of |        |        |        |        |        |        |
|---|-----------------------|-----------------|---|--------|--------|--------|--------|--------|--------|
|   |                       |                 | 0–15m   | 15–20m | 20–25m | 25–30m | 30–35m | 35–40m | 40–50m |
| Leading right-turn clear before opposing approach (35 km/h) [1] | -12% to -8%           | 3,0             | 1.5   | 2.0    | 2.5    | 3.0    | 3.5    | 4.0    | 5.0    |
|   | -8% to -3%            | 3,0             | 1.0   | 1.5    | 2.0    | 2.5    | 3.0    | 3.5    | 4.5    |
|   | -3% to +3%            | 3,0             | 1.0   | 1.0    | 1.5    | 2.0    | 2.5    | 3.0    | 4.0    |
|   | +3% to +8%            | 3,0             | 1.0   | 1.0    | 1.0    | 1.5    | 2.0    | 2.5    | 3.5    |
|   | +8% to +12%           | 3,0             | 1.0   | 1.0    | 1.0    | 1.5    | 2.0    | 2.5    | 3.5    |
| Other left- and right-turn movements (35 km/h) [2]              | -12% to -8%           | 3,0             | 2,5   | 3,0    | 3,5    | 4,0    | 4,5    | 5,0    | 6,0    |
|   | -8% to -3%            | 3,0             | 2,0   | 2,5    | 3,0    | 3,5    | 4,0    | 4,5    | 5,5    |
|   | -3% to +3%            | 3,0             | 2,0   | 2,0    | 2,5    | 3,0    | 3,5    | 4,0    | 5,0    |
|   | +3% to +8%            | 3,0             | 2,0   | 2,0    | 2,0    | 2,5    | 3,0    | 3,5    | 4,5    |
|   | +8% to +12%           | 3,0             | 2,0   | 2,0    | 2,0    | 2,5    | 3,0    | 3,5    | 4,5    |
| 50 km/h   | -12% to -8%           | 3,5             | 2,5   | 3,0    | 3,0    | 3,5    | 4,0    | 4,5    | 5,0    |
|   | -8% to -3%            | 3,0             | 2,5   | 2,5    | 3,0    | 3,5    | 4,0    | 4,0    | 5,0    |
|   | -3% to +3%            | 3,0             | 2,0   | 2,0    | 2,5    | 3,0    | 3,0    | 3,5    | 4,5    |
|   | +3% to +8%            | 3,0             | 2,0   | 2,0    | 2,0    | 2,5    | 2,5    | 3,0    | 4,0    |
|   | +8% to +12%           | 3,0             | 2,0   | 2,0    | 2,0    | 2,0    | 2,5    | 3,0    | 3,5    |
| 60 km/h   | -12% to -8%           | 4,0             | 2,5   | 3,0    | 3,0    | 3,5    | 4,0    | 4,0    | 4,5    |
|   | -8% to -3%            | 3,5             | 2,5   | 2,5    | 3,0    | 3,0    | 3,5    | 4,0    | 4,5    |
|   | -3% to +3%            | 3,0             | 2,0   | 2,5    | 2,5    | 3,0    | 3,5    | 3,5    | 4,0    |
|   | +3% to +8%            | 3,0             | 2,0   | 2,0    | 2,0    | 2,5    | 2,5    | 3,0    | 3,5    |
|   | +8% to +12%           | 3,0             | 2,0   | 2,0    | 2,0    | 2,0    | 2,5    | 2,5    | 3,5    |
| 70 km/h   | -12% to -8%           | 4,5             | 2,5   | 3,0    | 3,0    | 3,5    | 3,5    | 4,0    | 4,5    |
|   | -8% to -3%            | 4,0             | 2,5   | 2,5    | 3,0    | 3,0    | 3,5    | 3,5    | 4,0    |
|   | -3% to +3%            | 3,5             | 2,0   | 2,0    | 2,5    | 2,5    | 3,0    | 3,0    | 4,0    |
|   | +3% to +8%            | 3,5             | 2,0   | 2,0    | 2,0    | 2,0    | 2,5    | 2,5    | 3,0    |
|   | +8% to +12%           | 3,5             | 2,0   | 2,0    | 2,0    | 2,0    | 2,0    | 2,0    | 2,5    |
| 80 km/h   | -12% to -8%           | 5,0             | 3,0   | 3,0    | 3,5    | 3,5    | 4,0    | 4,0    | 4,5    |
|   | -8% to -3%            | 4,5             | 2,5   | 2,5    | 2,5    | 3,0    | 3,0    | 3,5    | 4,0    |
|   | -3% to +3%            | 4,0             | 2,0   | 2,0    | 2,5    | 2,5    | 3,0    | 3,0    | 3,5    |
|   | +3% to +8%            | 4,0             | 2,0   | 2,0    | 2,0    | 2,0    | 2,0    | 2,5    | 2,5    |
|   | +8% to +12%           | 4,0             | 2,0   | 2,0    | 2,0    | 2,0    | 2,0    | 2,0    | 2,5    |

The all-red interval may be increased by 0,5 seconds if an integer intergreen (yellow plus all-red) interval is required

| Speed limit or advisory speed | Additional all-red intervals for clearance widths W <sub>s</sub> of |        |        |        |        |        |        |        |
|-------------------------------|---|--------|--------|--------|--------|--------|--------|--------|
|                               | 0-10m   | 10-15m | 15–20m | 20–25m | 25–30m | 30–35m | 35–40m | 40–50m |
| Turns (35 km/h)               | 1.0   | 1.5    | 2.0    | 2.5    | 3.0    | 3.5    | 4.0    | 5.0    |
| 50 km/h                       | 0.5   | 1.0    | 1.5    | 1.5    | 2.0    | 2.5    | 3.0    | 3.5    |
| 60 km/h                       | 0.5   | 1.0    | 1.0    | 1.5    | 1.5    | 2.0    | 2.5    | 3.0    |
| 70 km/h                       | 0.5   | 0.5    | 1.0    | 1.0    | 1.5    | 1.5    | 2.0    | 2.5    |
| 80 km/h                       | 0.5   | 0.5    | 1.0    | 1.0    | 1.5    | 1.5    | 1.5    | 2.0    |

## NOTES

- 1 A shorter all-red or clearance interval is allowed for a leading right-turn movement followed by straight-through and left-turn movements from the opposite approach.
- 2 A speed of 35 km/h is assumed for turning movements. A higher speed may be required depending on the geometric layout of a junction.

- 3 Longer all-red intervals than those given in Table 6.1 may be required under the following circumstances:
  - (a) When a slipway is provided (see discussion below).
  - (b) When a protected left-turn phase is introduced immediately following a main signal phase during which right-turning movements were permitted. Field observations are required to establish the all-red interval that would allow right-turning vehicles to clear the junction before the onset of the left-turn phase.
- 4 When one of the signal faces S10L, S10R, S10B or S10T are used, the provision of the clearance (or all-red) interval would mean that no light signal would be displayed on these faces during (or after) this interval. A red signal would, however, be displayed to other conflicting traffic movements.

#### 6.12.4 All-red interval for approaches with signalised slipways

- 1 The provision of a signalised slipway at a junction could result in very long all-red intervals due to the long clearance distances involved. As shown in Figure 6.3, provision must be made for an additional clearance width ( $W_s$ ) to clear the slipway.
- 2 Different all-red intervals may be used for the main approach and the slipway. A normal all-red period can be provided for the main approach, while a longer all-red period is only provided on the slipway. Where controllers do not make provision for different all-red periods, a late start can be introduced on the slipway to achieve the same effect. A late start of a few seconds would allow conflicting vehicles to clear the conflict area before green is given to the slipway.
- 3 The additional all-red interval is required for straight-through vehicles from the right of the slipway, as well as right-turning vehicles from the opposite approach. The additional all-red period can be calculated by means of the following formula:

$$\text{Additional all-red} = \frac{W_s}{V/3.6}$$

- 4 The clearance distance  $W_s$  is measured from the continuation of the edge of the main carriageway nearest to the slipway, up to the furthest edge of the slipway as shown in Figure 6.3.
- 5 For straight-through vehicles from the right, the speed limit or advisory speed should be used in the formula. For right-turning vehicles from the opposite side, a lower speed of about 35 km/h may be used.
- 6 Practical values of the additional all-red interval calculated for a range of speeds and clearance widths are given in Table 6.2.

## 6.13 TRAFFIC SIGNAL TIMING

### 6.13.1 General

- 1 The optimisation of traffic signal timings is a complex exercise that requires a high level of expertise. Many methods have been developed for this purpose, some of which are more complex and refined than others. However, even with the most sophisticated methods, it is difficult to accurately predict traffic operations at junctions due to the variety of factors influencing such operations.
- 2 The general principle applied in all the methods is to use some model for the prediction of a level of service or performance index. The level of service is generally based on average vehicular delay, while the performance index is calculated as weighted sum of delay and number of stops. The purpose then is to find a set of traffic signal timings (and phasing) that would optimise the level of service or performance index (by minimising delay and number of stops).
- 3 A signal operating at a high level of service means that the junction is able to handle the amount of traffic adequately for most of the time, with acceptable delays and stops. At the other end of the scale, the lower levels of service are associated with high traffic demand, near or above the capacity of the signal, and excessive delays and stops.
- 4 Delay usually manifests itself as queues, which build up and diminish as the delay increases and decreases. Above a critical level of delay, long queues quickly develop and conditions become unstable, leading eventually to severe congestion with further increasing delay. This happens when the demand exceeds the capacity of the signal.
- 5 A desirable level of service occurs when delays and stops are less than what might be regarded as tolerable or acceptable. In addition to the operational advantages of having an acceptable level of service, there is an important safety implication. Each stop has the potential of becoming an accident, while each second of excessive delay adds to driver frustration, which results in them taking risks, thus increasing the probability of collisions.
- 6 Fixed time control signals require a compromise set of signal settings which would provide an acceptable level of service over the full period during which a particular timing plan is in operation, and not only for one particular 15-minute or 60-minute period. The practice according to which a model is used to optimise traffic signal timings for one particular hour, perhaps allowing for some peaking within the hour, has the danger that it may result in poor operations during other times the plan is in operation. A compromise plan should be developed which would ensure that excessive delays are not experienced at any time, and which would optimise operations over the full time period.

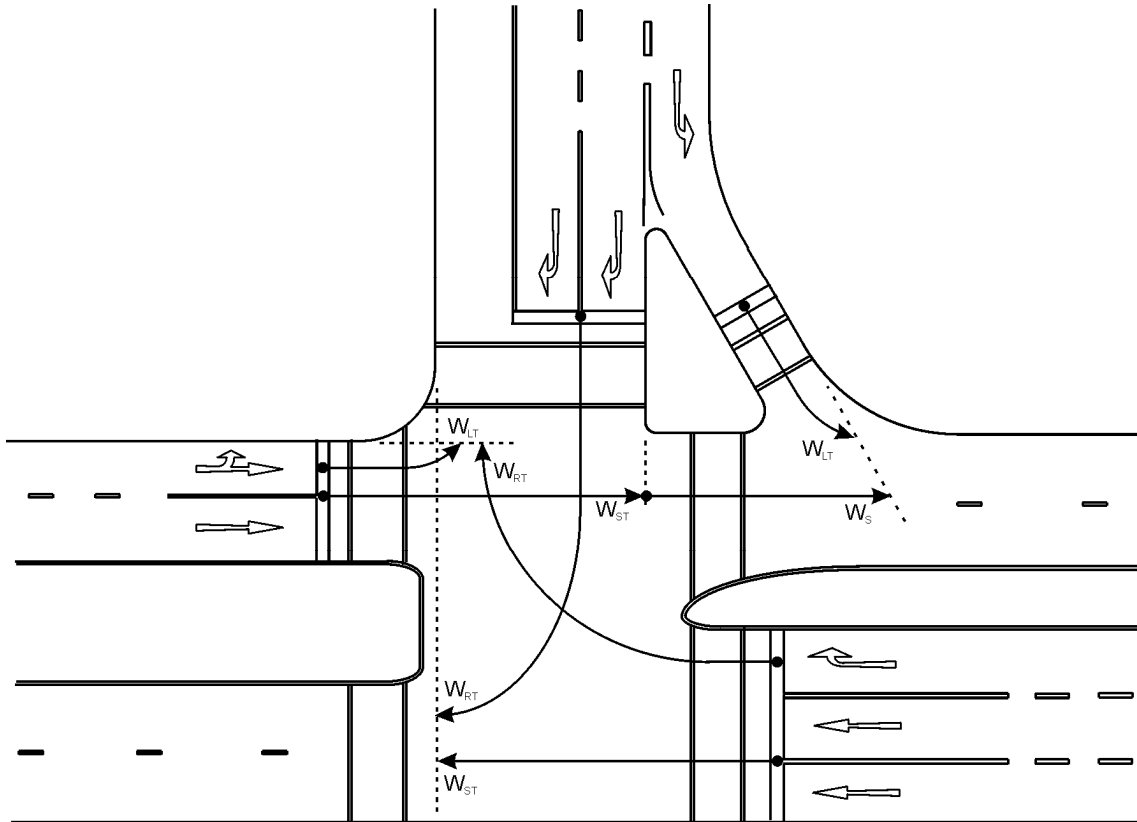

Figure 6.3: Measurement of clearance widths  $W$

### 6.13.2 Cycle length

- 1 The cycle length of a traffic signal is the duration of a full sequence of green, yellow and red signals during which all approaches are served.
- 2 In general, shorter cycle lengths are desirable because delay is reduced (except when traffic volumes are high). Cycle lengths shorter than 30 seconds, however, would not meet minimum green requirements, while cycle lengths longer than 120 seconds (and preferably not longer than 100 seconds) should not be provided since drivers tend to assume that the signals are not operating and start to move through on red. The optimum cycle length will in most cases lie in the range 50 to 100 seconds.
- 3 In many cases, the optimum cycle length would be based on network considerations. Co-ordination of signals is often the main determinant of the cycle length in a signal network.

### 6.13.3 Safety minimum green

- 1 The safety minimum green time is the shortest interval that a normal driver would expect the green light signal to run and it is required to avoid the situation where a vehicle starts off and then is almost immediately faced with a red light signal; the vehicle is not travelling fast and the driver doesn't know whether to go on or stop, and the one behind is even less certain as to what the one in front is going to do.
- 2 A safety minimum green is mandatory in all electronic controllers, independent of any user-set timing, and violation of this must set the red signal aspects into flashing mode.
- 3 The minimum safe green interval for a main signal phase shall not be less than 7 seconds, but preferably not less than 11 seconds. A left- or right-turn phase shall not be less than 4 seconds, but preferably not less than 7 seconds.

### 6.13.4 Manual method for timing traffic signals

- 1 There are various manual methods available for timing traffic signals. One of the best known of these methods is one developed by Webster (1958). A formula was developed by Webster for the optimum cycle length that would (approximately) minimise total delay at a junction:

$$C_o = \frac{1,5 \cdot L + 5}{1 - \sum Y_i}$$

in which:

$C_o$  = Optimum cycle length (seconds).

$L$  = Total lost time per cycle (seconds).

$Y_i$  = Volume/Saturation flow ratio per critical movement in stage  $i$ .

- 2 Webster also indicated that cycle lengths in the range  $0,75 C_o$  to  $1,50 C_o$  do not significantly increase delay. The equation, however, is very sensitive to the accuracy of lost time and saturation flow. It is also not possible to take minimum green times required by pedestrians into account.
- 3 An alternative, relative simple, method for establishing fixed time traffic signal timings is described below. Although the method is relatively simple, it can produce good signal settings, and sometimes even excellent settings. The method is a variation of the *critical movement analysis* method described by Webster and Cobbe (1966), the Highway Capacity Manual of the Transportation Research Board (1997) and in various other publications.
- 4 The method can be used to time relatively complex multi-phase signals. Signal phases can span more than one signal stage, and minimum green periods can be specified. The method can also easily be implemented as a computer spreadsheet program. The versatility of the method can be improved by such a spreadsheet implementation.
- 5 The manual method is based on the premise that traffic operations are efficient at a signal when:
- no traffic movement exceeds a prescribed maximum degree of saturation during ANY 15-minute interval over the period a signal plan is in operation; and
  - the critical traffic movements at the junction operate at the maximum degree of saturation during the most heavily loaded 15-minute interval.
- 6 The 15-minute intervals used in the analysis do not have to correspond for the different turning movements, and can occur at different times within a peak period.
- 7 Webster and Cobbe recommends a degree of saturation ( $X_m$ ) of 0,90 in signalised networks, but for remotely located or isolated junctions where traffic arrivals tend to fluctuate more, a lower value of 0,85 may be more appropriate.
- 8 The timing method consists of the following steps:
- Start with an estimate of the optimum cycle length  $C_o$ . In signalised networks, the common cycle length must be selected.
  - An estimate is made of the green intervals for each signal stage. The green interval for ONE of the stages can be calculated by subtracting the sum of green and intergreen intervals from the estimated cycle length.
  - Adjust green intervals (and the cycle length when the signal is isolated) until all five the following conditions are met:
    - Green intervals may not be shorter than minimum safety values.
    - Adequate time is available to accommodate all pedestrian or pedal cyclist phases.
    - Maximum degrees of saturation are not exceeded on any turning movement (0,85 for random arrivals and 0,90 for uniform arrivals). Note that different degrees of saturation may be used on different approaches to the same junction.
    - Degrees of saturation are equal (or approximately equal) for all critical turning movements (movements with the highest degrees of saturation).
    - Cycle length does not exceed a maximum of 120 seconds (preferably 100 seconds).
  - At isolated junctions, signal settings should be selected which would **minimise** the cycle length (and still meet the above conditions).
- 9 When the above method produces very long cycle lengths (longer than 120 seconds), it means that the signal will be operating at near-saturated or oversaturated conditions. When this occurs, the method can be used with a higher maximum degree of saturation of up to 0,95. However, it must be realised that the signal could then be operating at very high levels of delay.
- 10 The signal will operate at or above capacity when the maximum degree of saturation is calculated as greater or equal to 1,0. Under such conditions, the system will become unstable with very long queues and excessive delays. Geometric or other improvements will be required to accommodate the traffic demand.
- 11 The degree of saturation can be calculated using the following formula for each turning movement  $i$ :

$$X_i = \frac{Q_i}{(G_i - L_i) \cdot S_i / 3600 + I_i}$$

in which:

$X_i$  = Calculated degree of saturation for turning movement  $i$ .

$Q_i$  = Traffic demand on turning movement  $i$ , per cycle and per lane of traffic.

$G_i$  = Total green time allocated to turning movement  $i$  (over one or more stages).

$L_i$  = Total starting lost time experienced by turning movement  $i$ .

$S_i$  = Saturation flow for turning movement  $i$  (vehicles per green hour per lane).

$I_i$  = Total number of vehicles that can turn during the intergreen period.

- 12 The traffic demand  $Q_i$  per signal cycle, per lane, required in the above formula can be calculated by means of the following formula:

$$Q_i = \frac{P_i \cdot T_i \cdot C_o}{900}$$

in which:

$C_o$  = Cycle length (seconds)

$T_i$  = 15-Minute traffic count (vehicles per 15-minute interval) for turning movement  $i$

$P_i$  = Proportion of traffic in the heaviest loaded lane.

- 13 The proportion of traffic  $P_i$  in the heaviest loaded lane can be estimated as the inverse of the number of lanes available for a turning movement when there is equal utilisation of all lanes ( $P_i = 1/N_i$  with  $N_i$  the number of lanes). The lane utilisation should, however, be checked and a higher value of  $P_i$  used when it is found that drivers tend to avoid some of the available lanes (often due to double parking).
- 14 An example illustrating the method is given later in this chapter. The following section describes the parameters required by the method.

**6.13.5 Typical capacity parameters**

- 1 The parameters required for establishing traffic signal timings are starting lost time, the number of vehicles that turn during the intergreen period and the saturation flow rate per lane.
- 2 The starting lost time  $L_i$  is the time lost during the start of a green phase due to reaction time. This starting lost time is usually taken as 2 seconds.
- 3 The yellow effective green is the portion of the yellow interval which is effectively used by traffic as green time. This time is usually taken as 3 seconds.
- 4 The number of vehicles  $I_i$  that can turn during the intergreen period (per cycle, per lane) is usually calculated as follows:
  - (a) For left-turn and straight-through movements:

$$I_i = \frac{\text{Yellow effective green} \times \text{Saturation flow } S_i}{3600}$$

- (b) For right-turn movements, a value of  $I_i$  is usually taken as 1 vehicle per cycle at very narrow junctions, 2 vehicles per lane per cycle at average sized junctions, and 3 vehicles per lane per cycle at wide junctions.
- 5 Saturation flow  $S_i$  is the rate at which traffic will enter the junction during a green interval. It is important to note that saturation flow parameter is required in units of vehicles per hour rather than in passenger car units ( $pcu$ 's) per hour.

- 6 The estimation of saturation flow is a complex undertaking since it depends on a variety of factors, such as number of lanes, vehicle composition, the length of the auxiliary lanes, sharing of lanes between different streams, pedestrian volumes, gradient, time of day, driver composition, etc. A detailed method for the estimation of saturation flow is given in Highway Capacity Manual of the Transportation Research Board (1997).
- 7 At critical junctions, saturation flow should preferably be measured rather than estimated. Traffic signal settings are critically dependent on saturation flow, and a small error in saturation flow will result in errors in signal settings. A method for measuring saturation flow is described in the Highway Capacity Manual.
- 8 Typical values of saturation flow are given in the table below for the different turning movements. These values can be used when operating conditions are "average". It is, however, important to note that the range of saturation flows is very wide. The inappropriate choice of the saturation flow rate could lead to the calculation of unsuitable signal settings.
- 9 The estimation of the saturation flow for a permitted right-turn movement in which traffic is permitted to accept gaps is particularly complex. The saturation flow depends on traffic flow and queue formation on the opposite direction. When the opposite traffic flow is high, it is often assumed that no vehicles will accept gaps, and the saturation flow assumed to be zero.

| TYPICAL SATURATION FLOWS      |   |                           |
|-------------------------------|---|---------------------------|
| Turning movement              | "Typical" saturation flow (veh/hour/lane) | Range of saturation flows |
| Left-turn without pedestrians | 1800                                      | 1000 - 2000               |
| Straight-through              | 1800                                      | 1000 - 2500               |
| Right-turn                    |   |                           |
| Exclusive phase               | 1600                                      | 1000 - 2000               |
| Permitted                     | Varies                                    | 0 - 2000                  |

- 10 The saturation flows given in the above table only apply to junctions where separate lanes are provided for each turning movement. Where the saturation flows for the left-turn and straight-through movements do not differ significantly (as indicated in the table), the two movements can be combined and analysed as if one turning movement. The saturation flow for the left-turn movement, however, will be significantly lower than that for the straight-through movement at locations where heavy pedestrian volumes occur. The left-turn and straight-through movements cannot be combined at such locations.
- 11 It is not possible to combine permitted right-turn and straight-through movements due to the large difference in saturation flows. The movements, however, can be combined when an exclusive right-turn phase is provided.

### 6.13.6 Example calculations

- 1 The following is an example of the manual method for establishing optimum traffic signal timings. The example calculations are done for the T-junction shown in Figure 6.4. This junction is located on an arterial in the east-west direction that is part of a co-ordinated network. The southern leg to the junction does not form part of the co-ordinated system, and arrivals are random.
- 2 The junction is located on a flat terrain and the gradients on the approaches to the junction are less than 3%. The speed limit on all approaches is 60 km/h. The clearance width of the junction in the east-west direction is 17 m, from the stop line on the approach to the extension of the exit kerb line. In this direction, a 3,0 s yellow and 2,5 s all-red intervals are required. On the southern approach, 3,0 s yellow and 2,0 s all-red intervals are provided.
- 3 **There are no pedestrians at the junction, and no provision is made for pedestrian signals.**
- 4 The saturation flow and other parameters used for establishing the required traffic signal timings are given in Table A in Figure 6.4. Parameters are given for each turning movement, and are assumed equal for all three approaches to the T-junction.
- 5 A timing plan for the junction must be produced for a two-hour long weekday AM peak period. The system operates at a common cycle length of 70 seconds. The spacing of signals on the arterial is such that relative good progression can be obtained at this cycle length.
- 6 The east-west street is part of a co-ordinated system and the maximum degree of saturation on the street should not exceed a value of 0,90. The southern leg is effectively isolated, and the maximum degree of saturation should not exceed a value of 0,85.
- 7 Counts taken manually in 15-minute intervals over the peak period are given in Table B in Figure 6.4. The maximum volumes counted for each turning movement are highlighted in the table. The maximum volumes are used in the calculations to ensure satisfactory operations in each of the 15-minute intervals.
- 8 The right-turn movement from the west is relatively heavy and cannot be accommodated as a permitted movement. Assuming that no vehicles can accept gaps due to the heavy opposing traffic, and that only 2 vehicles can turn right during the intergreen, a total of 29 signal cycles will be required to allow 58 vehicles to turn right. With a 70 second cycle length, there are less than 13 cycles available in the 15-minute counting period, which do not provide adequate opportunity for right-turn on yellow. An exclusive right-turn phase is therefore required.
- 9 A T-junction with the geometric layout as used in the example allows the use of left-turn phases from both the east and the south. The signal can then be phased as shown in the staging diagram given in Figure 6.4. Three stages are provided:
  - (a) In Stage 1, green is given to all turning movements on the main east/west road, although for the purposes of this example, it is assumed that the right-turn movement from the west will not be able to find gaps in the opposing traffic from the east.
  - (b) In Stage 2, a lagging green phase is provided for the right-turn movement from the west, while the left-turn movement is allowed from the south.
  - (c) In Stage 3, green is given to the southern approach, while the left-turn movement is allowed from the east.
- 10 Calculations of degrees of saturation are shown in Table D for only one set of traffic signal settings, given in Table C in Figure 6.4.
- 11 Some turning movements (straight-through movement from west and left-turn movements from south and east) receive green signals over more than one signal stage. These green signals continue through the intergreen periods and the intergreen periods have been added to the duration of the green periods.
- 12 Table D shows that the critical turning movements are the straight-through and right-turn movements from the west, and the right-turn movement from the south.
- 13 For the set of signal settings given in Table C, the right-turn movement from the south is operating at the maximum degree of saturation of 85%, while the right-turn movement from the west is operating at nearly the maximum degree of saturation of 90%.
- 14 The third critical movement, namely the straight-through movement from the west is operating at a degree of saturation of 86% that is slightly lower than the maximum degree of saturation of 90%. This is because there is some spare green available in the common cycle length of 70 seconds.
- 15 The spare green could have been distributed amongst all three stages in such a way that the degrees of saturation would have been equal for all three critical turning movements. However, in the example, it is deemed advantageous to allocate the spare green to the co-ordinated arterial where progression can be improved by providing additional green.

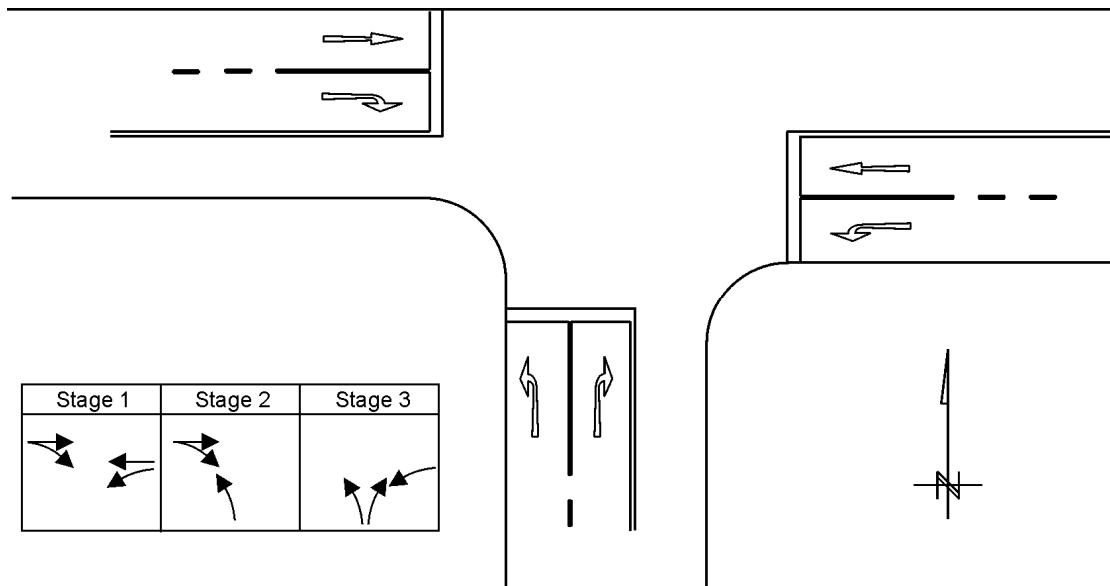

**TABLE A: EXAMPLE TIMING PARAMETERS**

| Turning movement | Saturation flow (veh/hour) | Starting lost time (sec) | Veh on intergreen |
|------------------|----------------------------|--------------------------|-------------------|
| Left-turn        | 1800                       | 2                        | 1,5               |
| Straight-through | 1800                       | 2                        | 1,5               |
| Right-turn       | 1600                       | 2                        | 1,5               |

**TABLE C: SIGNAL SETTINGS**

| Stage              | Green period (sec) | Intergreen (sec) |
|--------------------|--------------------|------------------|
| 1                  | 23,5               | 5,5              |
| 2                  | 10,0               | 5,5              |
| 3                  | 20,5               | 5,0              |
| Cycle length (sec) |                    | 70,0             |

**TABLE B: EXAMPLE TRAFFIC COUNTS (Vehicles per 15 minute interval)**

| Time begin | Time end | West       |           | East       |            | South      |            |
|------------|----------|------------|-----------|------------|------------|------------|------------|
|            |          | ST         | RT        | LT         | ST         | LT         | RT         |
| 07:00      | 07:15    | 181        | 54        | 121        | 93         | 104        | 95         |
| 07:15      | 07:30    | 214        | 55        | 133        | 97         | 121        | 98         |
| 07:30      | 07:45    | 220        | <b>58</b> | <b>141</b> | 99         | <b>133</b> | 109        |
| 07:45      | 08:00    | <b>222</b> | 51        | 137        | 108        | 121        | <b>118</b> |
| 08:00      | 08:15    | 218        | 45        | 126        | <b>111</b> | 118        | 111        |
| 08:15      | 08:30    | 216        | 53        | 119        | 101        | 106        | 115        |
| 08:30      | 08:45    | 191        | 49        | 118        | 94         | 109        | 101        |
| 08:45      | 09:00    | 153        | 45        | 111        | 93         | 96         | 99         |

**TABLE D: DEGREES OF SATURATION**

| Calculation Item | West  |      | East  |      | South |      |
|------------------|-------|------|-------|------|-------|------|
|                  | ST    | RT   | LT    | ST   | LT    | RT   |
| $T_i$            | 222   | 58   | 141   | 111  | 133   | 118  |
| $P_i$            | 1,0   | 1,0  | 1,0   | 1,0  | 1,0   | 1,0  |
| $Q_i$            | 17,27 | 4,51 | 10,97 | 8,63 | 10,34 | 9,18 |
| $S_i$            | 1800  | 1600 | 1800  | 1800 | 1800  | 1800 |
| $G_i$            | 39,0  | 10,0 | 49,0  | 23,5 | 35,5  | 20,5 |
| $L_i$            | 2     | 2    | 2     | 2    | 2     | 2    |
| $I_i$            | 1,5   | 1,5  | 1,5   | 1,5  | 1,5   | 1,5  |
| $X_i$            | 0,86  | 0,89 | 0,44  | 0,70 | 0,56  | 0,85 |

Figure 6.4: Example signal timing of a signalised T-junction

## 6.14 FIXED TIME SIGNAL CO-ORDINATION

### 6.14.1 General

- 1 Signal co-ordination is necessary in systems where upstream junctions influence operations at downstream junctions. Proper co-ordination can smooth traffic flow and reduce delay as well as number of stops, which are important benefits of a co-ordinated system.
- 2 Fixed time signals are particularly suitable for use in co-ordinated systems because of the repetitive nature of vehicle platoons occurring in such systems. Traffic demand in such systems is also less likely to fluctuate from cycle to cycle, with the result that fixed time signal timing plans can perform very well when they are properly determined and maintained.
- 3 Traffic demand may change throughout the day and different timing plans will be required to cope with such changes.

### 6.14.2 Timing of co-ordinated systems

- 1 The optimisation of co-ordinated signals is an even more complex exercise than that of single junctions. Manual methods are available for this purpose, but are not as accurate, particular when traffic volumes are high. Computer methods are generally preferred.
- 2 The timing of co-ordinated signals is also based on the optimisation of a performance index or level of service, although greater weight should be given to number of stops. Reducing the number of stops is an important objective in establishing optimum signal offsets.
- 3 In co-ordinated signal systems, a common cycle must be used at all signals. The use of such a common cycle length *synchronises* the signals and assures that the relative timings of the signals will be repeated regularly. This synchronisation can also be achieved by the selection of cycle lengths with a common multiple. Such multiple cycle lengths, however, are not often used in signalised systems.
- 4 Traffic signals are *co-ordinated* by establishing a set of signal *offsets* that determine relative time relationships between adjacent signals. The offset is the time at which a particular stage commences (sometimes the time at which an interstage commences) relative to a certain instant used as a time reference base. The same reference stage is normally selected for all signals in a system (typically stage number 1).
- 5 It is often only possible to properly co-ordinate signals on two-way roads in one direction. It is normal practice to favour the direction with heavier traffic flows. If both directions carry more or less equal traffic volumes, it will be necessary to compromise between the two directions.

### 6.14.3 Manual timing method for co-ordinated signals

- 1 The manual method for co-ordinating signals requires the calculation of cycle lengths that would satisfy the 0,90 maximum degree of saturation criterion. Cycle lengths are calculated for each signal in the system and usually the longest cycle length is selected to be the common one for the system (subject to maximum cycle length restrictions). The result of this approach is that the critical, heaviest loaded signal will be operating at 0,90 saturation, whilst all the others in the system will be less than this. The cycle length may be increased to improve signal co-ordination.
- 2 Signal offsets are established to allow vehicles to travel through the system without stopping. The offsets should therefore allow that a) the queue at a signal first departs before b) vehicles from the upstream junction arrive at the junction on green. The dispersion of platoons as they travel through the network should also be taken into account.
- 3 The calculation of the time required by the queue to depart, as well as the dispersion of platoons, is a complex exercise and cannot readily be undertaken manually. This problem is particularly important under heavy flow conditions.

### 6.14.4 Progression diagrams

- 1 A progression diagram (sometimes called a space-time or distance-time diagram) is a graphical representation of the spatial position of traffic signals and their relative signal timings. The positions of each signal along a single co-ordinated route are plotted usually on the horizontal axis and the signal timings, the red, yellow and green intervals for the phases serving the route, are then plotted vertically. An example is shown in Figure 6.5.
- 2 Once the common cycle time and the individual splits have been determined, the relative offset of each signal timing can be adjusted, by moving the signal timings vertically up or down, so as to obtain the best progression between the green windows of each signal. The key to this is in plotting the progression bands as pairs of lines sloping up and down (for the two directions of travel). These bands represent the flow of vehicles through the system. The slopes of the lines inversely represent progression speeds - the steeper the lines, the lower the speeds.
- 3 The process is largely one of trial and error, and in the final analysis, there is no quantified indicator of effectiveness of the final result (except bandwidth). Value judgements must be made by examination of the final progression diagram, taking due account of the traffic flows on each link.
- 4 In the example (Figure 6.5), there are 4 signals that are positioned (from 1<sup>st</sup> to 4<sup>th</sup> Streets) at 400 m, 300 m and 300 m apart. The cycle time has been established at 60 seconds and a progression speed of 60 km/h has been selected. The diagram shows that the bandwidth is relative narrow due the close spacing of the signals. The progression from 4<sup>th</sup> Street to 1<sup>st</sup> Street is slightly better than in the other direction.



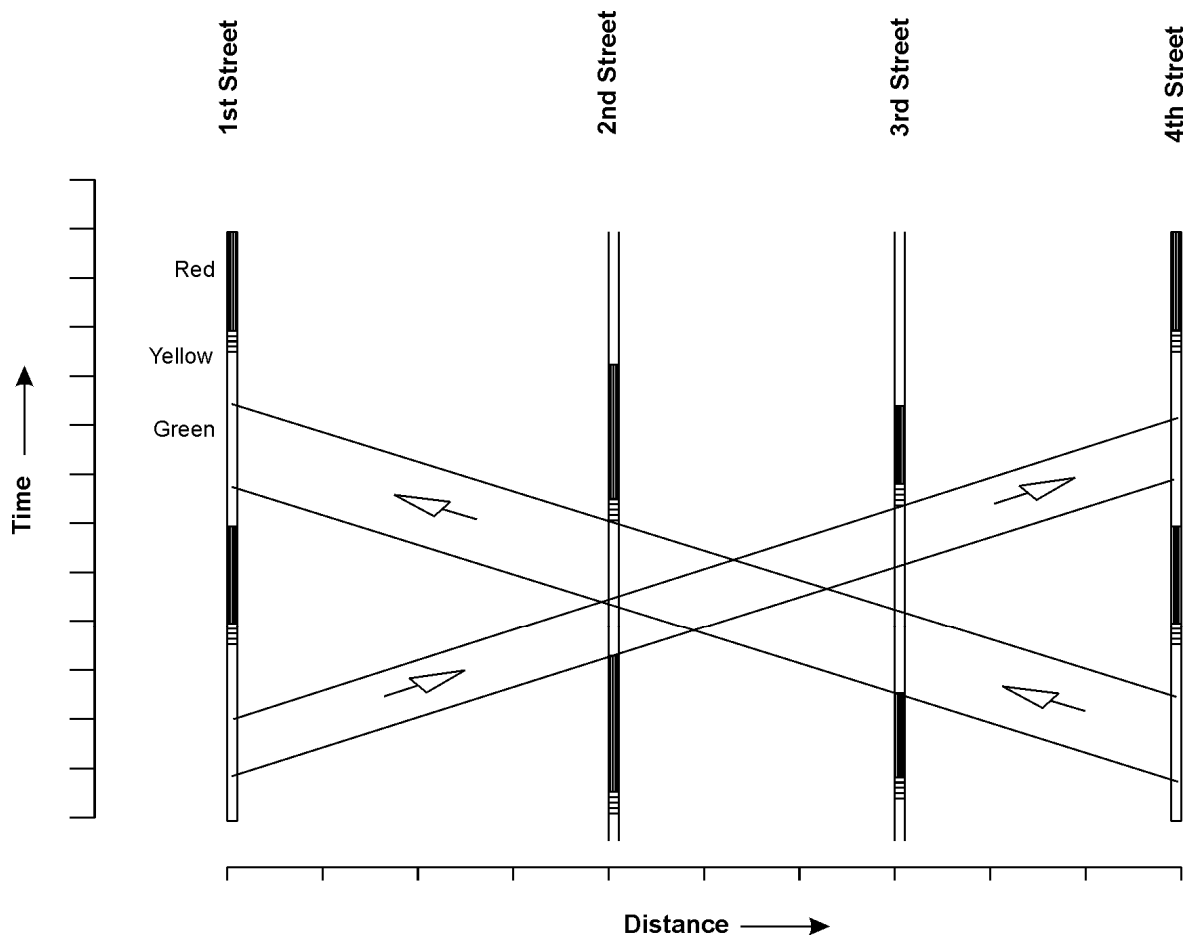

Figure 6.5: Example progression diagram

#### 6.14.5 Platoon dispersion diagrams

- 1 Traffic signal co-ordination should preferably be undertaken using traffic flow models that adequately account for queue formation and platoon dispersion. These models require complex calculations that can only practically be done on a computer.
- 2 Various computer models are available for modelling traffic flow in a network of signalised roads and streets. Some of these models use “macroscopic simulation” techniques to manipulate average flow patterns as shown in Figure 6.6. Two important patterns are shown in this figure, namely the IN and OUT flow patterns.
- 3 The IN flow pattern indicates how average traffic flow rate would have varied if green signals were continuously displayed at the signal. The IN pattern therefore provides an indication of traffic **demand** throughout the signal cycle. The variation in the pattern is representative of platoon dispersion as it moves down a link. A typical platoon will consist of a “head” representing the queue that departs from the upstream junction, and a “tail” representing vehicles that have arrived at the upstream junction after the queue has departed.
- 4 The OUT flow pattern indicates average traffic departures from the stop line. This pattern is typically zero while the signal is red. During the early part of green, it shows a peak corresponding to saturation flow rate. For the remainder of the green period, the out pattern follows the IN pattern because outflow is then equal to inflow.
- 5 The output of a macroscopic simulation model is shown in Figures 6.7a and 6.7b. The figures show traffic flow patterns on a distance-time diagram similar to the one in Figure 6.5. The positions of the signals are shown on the horizontal axis, and the signal timings on the vertical axis. Progression speeds are shown as sloped lines in both directions of travel (a progression speed of 60 km/h was used in the model).
- 6 Two sets of flow patterns are shown in the figures for each signal on the route, one for each of the two directions of travel. The IN flow patterns are indicated by solid lines, while the OUT flow patterns are shown by broken lines.

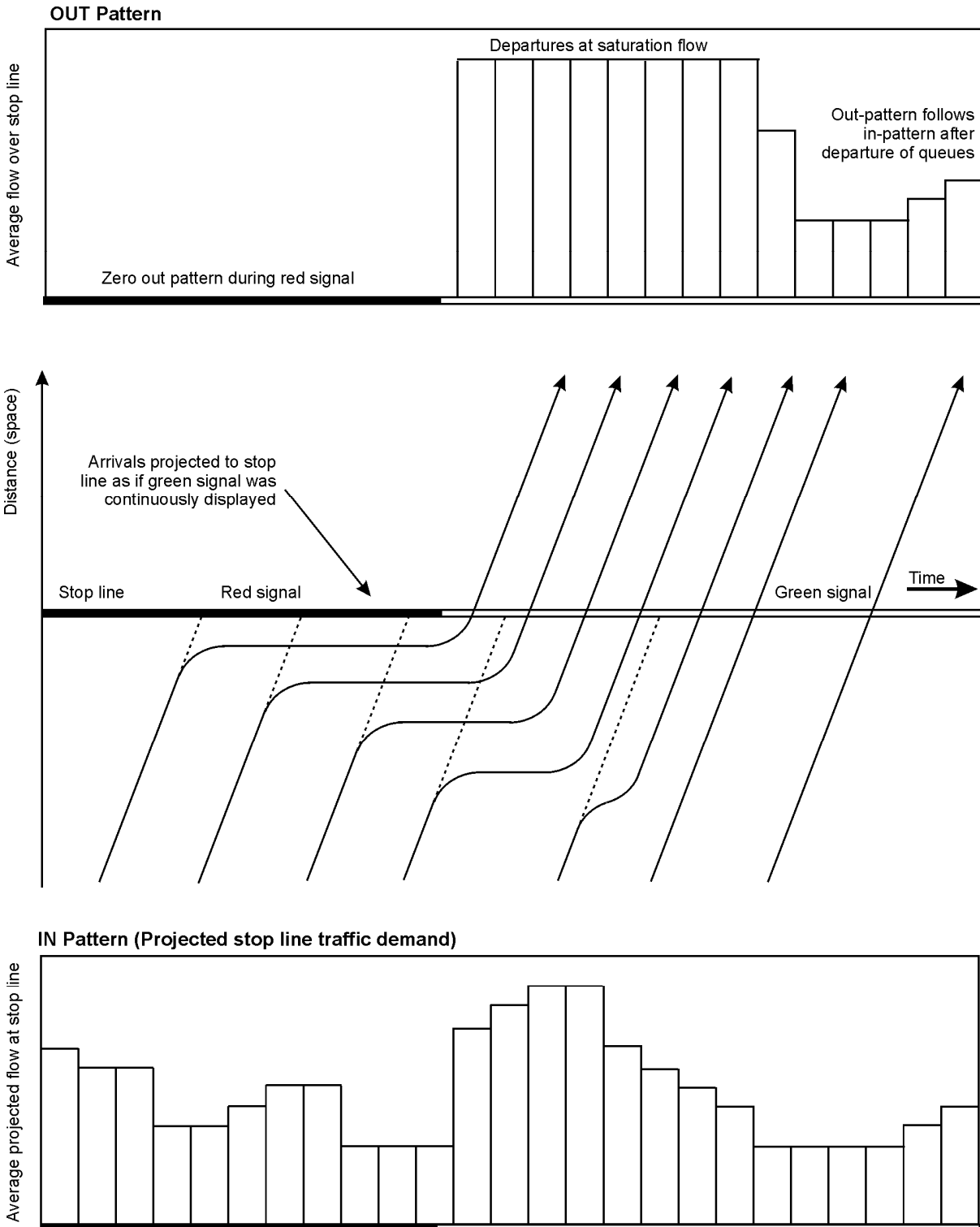

Figure 6.6: IN and OUT flow patterns at a traffic signal

- 7 Ideally, a platoon should arrive at a signal after the queue has departed from the signal. Any platoon of vehicles arriving either during the red period or while the queue is departing, will have to stop and experience delay. Progression would then be poor.
- 8 The platoon dispersion diagram in Figure 6.7a shows the traffic flow patterns for the same traffic signal timings used in Figure 6.5. The flow patterns indicate that platoons travelling from 1<sup>st</sup> Street to 4<sup>th</sup> Street continually have to stop at the next signal. Few vehicles are able to travel in this direction without stopping.
- 9 The progression in the other direction from 4<sup>th</sup> Street to 1<sup>st</sup> Street is somewhat better, although platoons arriving at the 2<sup>nd</sup> and 3<sup>rd</sup> Streets have to stop. At these two streets, the progression is poor in this direction. The only acceptable progression occurs at 1<sup>st</sup> Street where the platoon arrives after the queue has departed.
- 10 An alternative solution is shown in Figure 6.7b that allows for somewhat better progression in both directions. Most platoons arrive after the queues have departed, or departed partially. The progression, although not perfect, is significantly better than that shown in Figure 6.7a.
- 11 The above example illustrates the need for using sophisticated traffic flow models in signal co-ordination problems. Such models, however, are not always readily available, and use will have to be made of the manual method of constructing progression diagrams. It should, however, be realised that such diagrams have certain limitations and that fine-tuning in the field will probably be required. However, such fine-tuning will anyhow also be required even if the most sophisticated models are used.

#### 6.14.6 Progression speed

- 1 Progression speed is the average speed at which vehicles would be travelling should there have been perfect progression. Progression speed can be estimated, but it should preferably be measured.
- 2 The measurement of progression speeds can be undertaken by directly measuring speeds of vehicles or by the floating vehicle method. In the floating vehicle method, a driver in a test vehicle attempts to drive at the average of the speeds selected by other drivers. It is important that a calibrated speed measuring device is available in the test vehicle.
- 3 The floating vehicle method has the advantage that speed can be measured relatively easy over a length of road. Direct measurement of speeds may require observations at several points along a road.
- 4 Care should be taken to exclude the effect of the downstream junction, as well as vehicles queued at the junction, on progression speeds. The speed measurements should therefore be taken some distance away from this junction.
- 5 The progression speed can be different for different periods of the day. During peak periods, the speed would typically be lower than during off-peak periods, depending on how heavily the road network is loaded with traffic during the different periods. Different speed measurements may be required for the different time periods.

#### 6.14.7 Co-ordinated signals and speeding

- 1 The co-ordination of traffic signals can lead to speeding on a road or street. It is therefore important that signals should not be co-ordinated for a progression speed higher than the speed limit on the road.
- 2 Speeding may occur when green light signals are displayed *simultaneously* continuously along a street. Drivers confronted with a series of green light signals on a road will be tempted to speed to avoid being caught on red at a downstream junction.
- 3 Green that is terminated too soon at a junction may also result in speeding. Drivers quickly learn the signal timings along a road, and they may resort to speeding in order to reach a junction while it is still displaying a green light signal.

#### 6.14.8 Obstructive (damaging) queue lengths

- 1 Obstructive or damaging queue lengths are those that block upstream junctions and accesses or that interfere with the progression of traffic. It is important that attention should be given to such queues when establishing timings for co-ordinated traffic signals.
- 2 One simple and direct way of reducing queue lengths is to increase the amount of green given to a particular approach. This can be done by shifting green time from one approach to another, if spare green is available on such an approach. A shift of as little as two seconds can produce a dramatic change in queue length on saturated approaches. Two seconds of additional green time per cycle will generally allow one more vehicle per lane to clear the junction each cycle. If a queue has been building for 20 cycles, an additional two seconds per green can mean a reduction in queue length of 20 vehicles.
- 3 It may also be possible to reduce queue lengths by using shorter cycle lengths. Longer cycle lengths have longer red periods during which long queues will build up. This option, however, will only be successful if the network is not operating near to capacity.
- 4 Another method of reducing queue lengths is by providing protected right-turn phases when there is a heavy right-turn movement. Providing such phases may, however, reduce the amount of green time available for other turning movements. It is important that proper attention should be given to the optimal timing of each phase.
- 5 It may also be possible to improve the capacity of a junction through geometric improvements such as additional lanes, increasing turn radii, etc. In some cases, it may be possible to simply improve delineation through a junction.

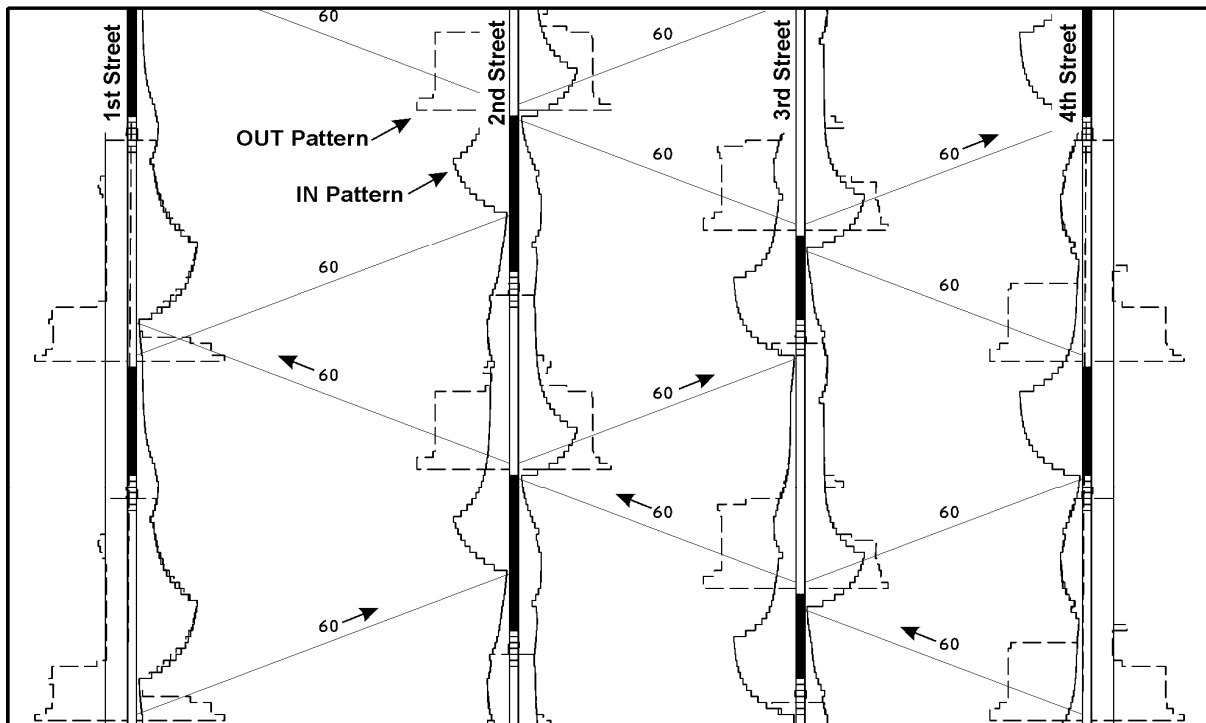

Figure 6.7a: Example platoon dispersion diagram

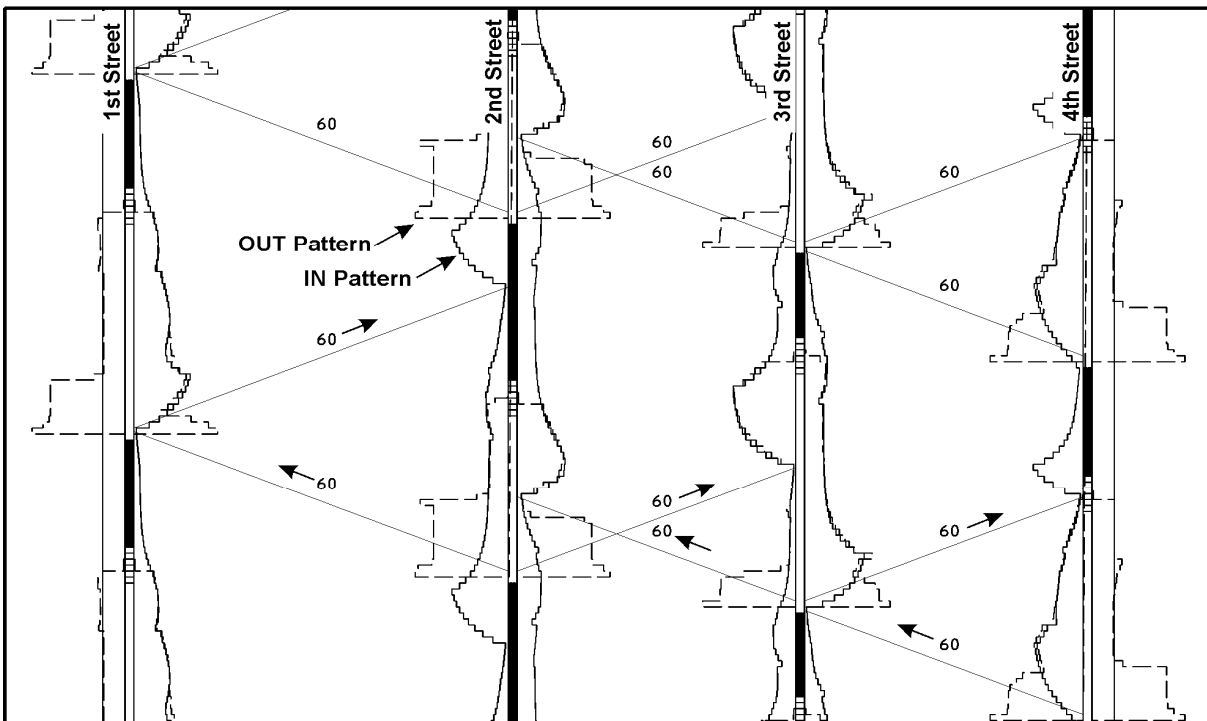

Figure 6.7b: Example platoon dispersion diagram with improved offsets

- 6 Where it is not possible to increase the capacity of a junction, consideration can be given to implement “metering” methods whereby the rate of vehicle arrivals is reduced. This can be achieved by reducing green times at upstream junctions. A reduction in arrival rate of one vehicle per upstream cycle could mean a reduction in queue length of 20 vehicles after 20 cycles.
- 7 The metering method is only effective when there is an upstream location available in the system where long queues can be accommodated. A possible location for storing such long queues is at large traffic generators such as parking areas. Signals can be installed at such generators that will only release as many vehicles that can effectively be handled by the street network. The queues will then form inside the generators rather than on the network where they may block junctions and reduce the capacity of the network.
- 8 Where it is not possible to reduce queue lengths by increasing capacity or reducing traffic demand, use can be made of “reverse progression” in which queues are first allowed to depart from a junction before traffic from the upstream junction is allowed to enter.

#### 6.14.9 Timing plan transition

- 1 The transition from one timing plan to another is not a trivial problem. Different timing plans could have different cycle lengths and phase sequences. Proper transition is then required to minimise disruption to traffic flow.
- 2 Care should be taken in timing plan transitions to ensure that minimum greens, intergreens and pedestrian clearance intervals are not violated or that excessive queues do not build up.
- 3 The most basic transition method is the “extended main-street green” in which a timing plan is kept in force until main-street green is about to end. The main-street green is then extended up to the time at which the *new* timing plan calls for its termination. This method has the disadvantage that it can result in some main-street greens that are very long, but it has the advantage that it is simple to implement.
- 4 An alternative method is to restrict the main-street green extension to a maximum of say 10 seconds. The transition is then achieved over more than one cycle. This method has the advantage that the length of the main-street green can be restricted, but has the disadvantage that a long transition period may be required. Such long transition periods could lead to serious disruptions in traffic operations.
- 5 A more efficient transition can be achieved by extending all green periods at a signal by using a longer cycle but fixed green splits. Transition can be achieved over a shorter period without extending one particular green unnecessarily long. The algorithm to implement this form of transition, however, is complex and the method relatively difficult to implement.

### 6.15 FINE-TUNING TRAFFIC SIGNALS

- 1 Calculated signal settings will usually need to be fine tuned after they have been in operation for a while. Once the traffic patterns and behaviour have settled down, observations should be made of the effectiveness of the signal operation in dealing with the volumes of traffic. Minor adjustments can then be made to the timings in the light of these observations. Major anomalies or inefficiencies may require a more comprehensive updating of signal timings, and possibly phasing, with further data collection.
- 2 Various methods of fine-tuning have been proposed and have been used. One of these is by undertaking delay (or queue length) studies. The signal settings can be adjusted and the delay study repeated. This, however, is a time consuming process and is therefore often not undertaken.
- 3 A simpler, but not as accurate, method is to observe the “utilisation” of each critical green phase. This utilisation is determined as the amount of green time actually utilised by vehicles as a percentage of the total available green. This utilisation should be about equal for all critical green phases, and should not be more than 85% for remotely located or isolated junctions and 90% in signalised networks.
- 4 Signal offsets can be fine-tuned by observing platoons arriving at signals. Good offsets are obtained when a platoon arrives just as the queue at a signal departs, in such a way that the platoon and the queue combine and form a new platoon towards the next traffic signal.
- 5 The requirements of pedestrians are paramount when timing signals. It is often the case that the pedestrian clearance interval determines the length of the vehicular green period. In this case, there is little that can be done to alleviate the problem by adjusting signal timings, so other measures should be investigated, e.g. providing pedestrian phases only on demand using push buttons, construction of central refuges, or grade separation.

### 6.16 SIGNAL TIMING CONFIGURATION DIAGRAMS

#### 6.16.1 General

- 1 Traffic signal timings and phasing must be documented and approved by a responsible registered professional engineer or registered professional technologist (engineering) of the road authority concerned. These timings must be shown on diagrams that must be kept by the road authority in control of the traffic signals.
- 2 An example of signal timing diagrams is given in Figures 6.8a to 6.8d. The example applies to a four-legged junction, in which right-turn phases are provided in the north/south direction. The signal can be operated in full-actuated, linked semi-actuated or linked fixed time control modes. Detectors are provided on all approaches.

### 6.16.2 Signal group and staging diagrams (Figure 6.8a)

- 1 Figure 6.8a contains signal group [SABS phase] and staging diagrams. The geometric layout of the junction is shown together with detector loops and the detector unit numbers to which the loops are connected. Signal group numbers have been allocated to traffic signal faces controlling various turning movements. Vehicular signal groups have been numbered from A to G while pedestrian signal groups have been numbered I to K.
- 2 Stage definitions are also shown in Figure 6.8a. Provision has been made for all possible stages that may be used at the junction in any signal plan. Specific stages will be selected for use in each signal plan (in subsequent tables).
- 3 The stages defined in the example provide for flexibility in the provision of right-turn phases on the northern and southern approaches. Stage 2 can be provided when there is a demand for right-turn phases on both approaches while Stages 3 and 4 can be provided when there is a demand on only one of the approaches. Stage 5 can be provided when the above flexibility in selecting right-turn phases is not required and there is a demand on either of the two approaches (such as with linked semi-actuated control).
- 4 **The stages must be numbered according to the sequence in which they are to be displayed. The controller examines stages sequentially according to stage numbers and will implement the next stage that is allowed in a plan (if it is not skipped).**

### 6.16.3 Signal group and stage data tables (Figure 6.8b)

- 1 Figure 6.8b shows a number of tables required for defining various types of signal group [SABS phase] and stage data. The data given in these tables are the same for all signal plans, and no differentiation is made at this stage between different signal plans. Five tables are shown in the figure.
- 2 The first table defines data for each signal group. This table contains the following data:
  - (a) Signal group [SABS phase] number (letters have been used to number the signal groups).
  - (b) Type of phase served by signal group (main phase, left-turn phase, right-turn phase, pedestrian phase or pedal cyclist phase).
  - (c) A delay period by which the onset of the green period is delayed. This facility can be used for various purposes. An important use is on slipways to provide additional all-red period to allow crossing vehicles to clear the slipway before the onset of green.
  - (d) For vehicular phases, the lengths of the minimum **safety** green, yellow and all-red intervals. The shortest all-red interval required by each phase is entered (longer all-red periods can be indirectly specified in the second table).

- (e) For pedestrian and pedal cyclist phases, the lengths of the steady green, flashing red and minimum steady red intervals are required.
- (f) Some signal phases can continue over a number of stages. The P/N code in the table indicates whether green must start or end during the previous or next intergreen intervals.
- (g) Definition of signal groups [SABS phases] that would be in conflict with each other. Whenever the controller detects that right of way is given to any of the conflicting signal groups it reverts to flashing mode. Signal groups A and E, for example, are conflicting since it would be unsafe if they were displayed simultaneously. This is a very important safety feature and requires careful attention. Some controller configuration programs can generate this table from other supplied data, and the data is then not required.
- 3 The second table defines permitted stage to stage movements as well as interstage times. When a controller is in one particular stage, it will only move to the next stage when such movement is permitted in the table. When the controller is, for example, in Stage 2, it can move to Stages 1 and 6 but not to Stages 2, 3, 4 or 5.
- 4 The interstage time between two stages must be at least as long as the longest yellow plus all-red time defined in the signal group data table. **When a longer interstage time is entered, the all-red period is extended.**
- 5 The third table is used to define detector data. This table can be ignored when no loop detectors are provided. When detectors are provided, the following data must be entered:
  - (a) Detector unit number, the index number of the detector unit and not the loop. More than one loop can be connected to a detector unit.
  - (b) Signal group number called and extended by the detector (required by some controller configuration programs).
  - (c) Extension time, the time the green period is extended when a vehicle moves off a detector loop. The green is continuously extended while a vehicle is detected on a loop. The extension time can be made zero, in which case a detector only serves as a calling detector.
  - (d) Whether calls should be latched or not. When a call is not latched, a call by a vehicle is dropped as soon as it moves off a detector loop. Long stop line calling detector loops (4 m long) are used in the example, and it is therefore not necessary to latch the calls. Extension loops do not need to be latched.
  - (e) Call delay, the time by which a call is delayed.
- 6 The last table is used to *program* the method according to which the controller selects stages. The method used in the example requires Boolean (logical) equations. Another method that is used in some controllers requires the writing of a computer program for this selection process. The Boolean method is somewhat simpler, but may not be as flexible as the programming method.

- 7 The Boolean method logically combines different detector calls to establish whether a stage should be implemented. Stages are examined *sequentially* (according to stage numbers), and the first stage implemented which is both allowed and for which the Boolean equation is TRUE. If the logic indicates a FALSE value, the next allowable stage is examined for possible implementation. Allowable stages are those for which the stage movement is permitted.
- 8 The following Boolean operators can be used in the logical equations:
  - (a) An OR operator according to which a stage will be implemented when a call has been placed at ANY of the indicated detector units.
  - (b) An AND operator according to which a stage will be implemented when a call has been placed at ALL the indicated detector units.
  - (c) A NOT operator according to which a stage will be implemented when a call has NOT been placed at ALL the indicate detector units. The NOT and AND operators can be combined.
  - (d) Parenthesis may be used to give higher precedence to specific portions of a logical equation.
- 9 In the example, stages are selected as follows:
  - (a) Stage 1 will be selected when a demand has been registered at detector units 7 or 8 or the pedestrian detector unit P3.
  - (b) Stage 2 will be selected when a demand has been registered at both detector units 2 AND 5. The double right-turn green will only be provided when there is a right-turn demand on both approaches.
  - (c) Stage 3 will be selected when a demand has been registered at detector unit 2 (since stage 2 is first tested, this stage would be selected when NO demand has been register at detector 5).
  - (d) Stage 4 will be selected when a demand has been registered at detector unit 5 (and there is NO demand registered at detector 2).
  - (e) Stage 5 will be selected when a demand has been registered at either of the two detector units 2 OR 5.
  - (f) Stage 6 will be selected when a demand has been registered at detector units 1,3,4 OR 6, or at the pedestrian detector units P1 or P2.
- 10 Note that the stage sequencing table does not allow for any movement between Stages 2 to 5 (except from Stage 3 to Stage 4). This means that only one type of right-turn phase will be provided (except that Stage 4 may follow Stage 3). Stage 6 will be implemented after any of the right-turn phases, but only if a demand has been registered for the stage.
- 11 In addition to specifying the stage selection method, it is also necessary to specify the detectors that extend a particular stage. These may be the same detectors used to register demands, or they may differ. In the example, only subsets of the detectors are used to extend stages.

#### 6.16.4 Signal plan and timing tables (Figure 6.8c)

- 1 The traffic signal data provided so far do not differentiate between traffic signal plans and are therefore generic to all signal plans. This in fact means that safety related provisions should have been made for the needs of all the traffic signal plans, even if no reference has been made to any of the signal plans.
- 2 Two tables are used in Figure 6.8c for the definition of signal plan and timing data. The first table is an event table that shows the days of the week (and holidays) and the times a signal plan is in operation. The second table provides timing data for signal stages.
- 3 Some controllers allow a signal plan to be used with different offsets, and the offsets are therefore defined as part of the event table. Note that the offsets in the example have been defined as the time at which Stage 1 starts relative to a base time.
- 4 A fallback plan number may also be specified. The controller reverts to this plan number when a fault is detected which is not serious enough to warrant flashing operations. The morning peak plan is often selected as the fallback plan.
- 5 Signal plans may be defined for different days of the week and time of day. Plans may also be defined for holidays. The following days may be defined:
  - (a) One of the seven days of the week, e.g. Mondays, Tuesdays, Wednesdays, etc.
  - (b) Mondays to Thursdays as a group.
  - (c) Mondays to Fridays as a group.
  - (d) Mondays to Saturday as a group.
  - (e) Holidays and Sundays.
  - (f) Holidays.
  - (g) Every day except holidays
  - (h) Every day including holidays.
- 6 Some controllers allow signal plans to operate in different modes of operation. In the example, the signal can operate in one of three modes of operation, namely fully-actuated, linked semi-actuated and linked fixed time.
- 7 Different subsets of signal stages may be selected for each traffic signal plan. The controller will only display these selected stages, in the sequence allowed by the permitted stage to stage movement table. Each stage can be indicated as a permanent always-run stage or one that can be skipped. A permanent stage will always be displayed even if no traffic demand has been registered. In linked semi-VA mode, the time saved by skipping a stage can be transferred to another specified stage number.
- 8 For each selected stage, minimum and maximum green periods must be given. The minimum times should not be shorter than the minimum safety times or the minimum time required by pedestrians given in the signal group data table.

- 9 In the example, a fully-actuated implementation is shown for Signal Plan 1. All five stages can be called in this plan, depending on whether demands have been registered for right-turn phases. All phases may be skipped in this plan. While a stage is being implemented, the controller continuously scans detectors for traffic demands (subject to the provision of minimum green). Once a demand is registered, the controller will implement the stage that satisfies this demand according to the stage selection process. Other stages for which no demand has been registered are skipped in this process.
- 10 A linked semi-actuated implementation is shown for Signal Plan 4. In this plan, only three of the available stages are used. Stages 1 and 6 must always be provided, while Stage 5 is provided only when there is a right-turn demand on both of the northern and southern approaches.
- 11 In Signal Plans 2 and 4, the signal is operated in linked fixed time mode. The application is relatively straightforward. Subsets of stages have been selected and all have been marked permanent, meaning that they must be implemented irrespective of traffic demand. Each plan allows for the provision of a right-turn phase, but this phase is always provided, irrespective of traffic demand.

## 6.17 BIBLIOGRAPHY

- 1 Institute of Transportation Engineers (ITE), 1985), *Determining vehicle change intervals*, Proposed recommended practice, ITE Journal, May 1985, pp 61-64.
- 2 Transportation Research Board, 1997, Highway Capacity Manual, Special Report, National Research Council, Washington.
- 3 Webster F.V. 1958, Traffic signal settings, Road Research Technical Paper No 39, Road Research Laboratory, UK.
- 4 Webster FV and Cobbe B.M. 1966, Traffic Signals, Road Research Technical Paper No 56, Road Research Laboratory, UK.



Signal groups and staging

Signal groups [SANS phases]

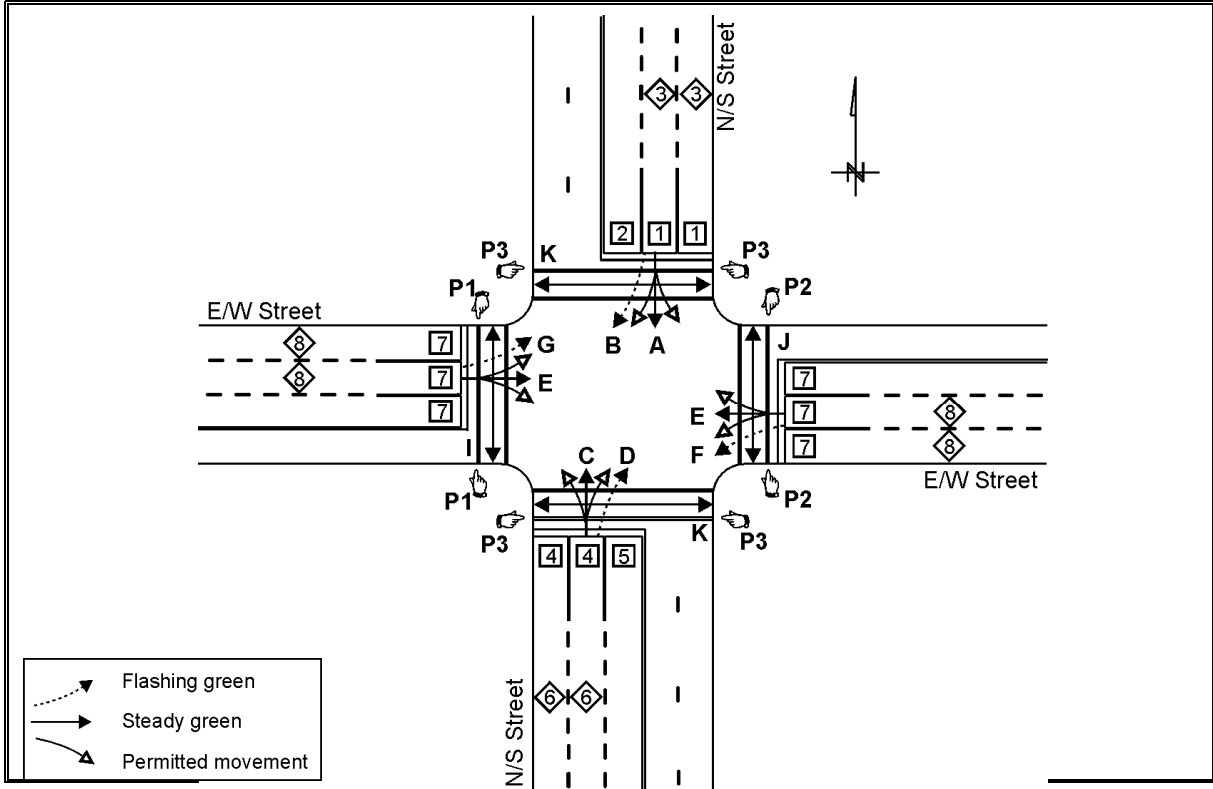

Signal staging (showing signal groups)

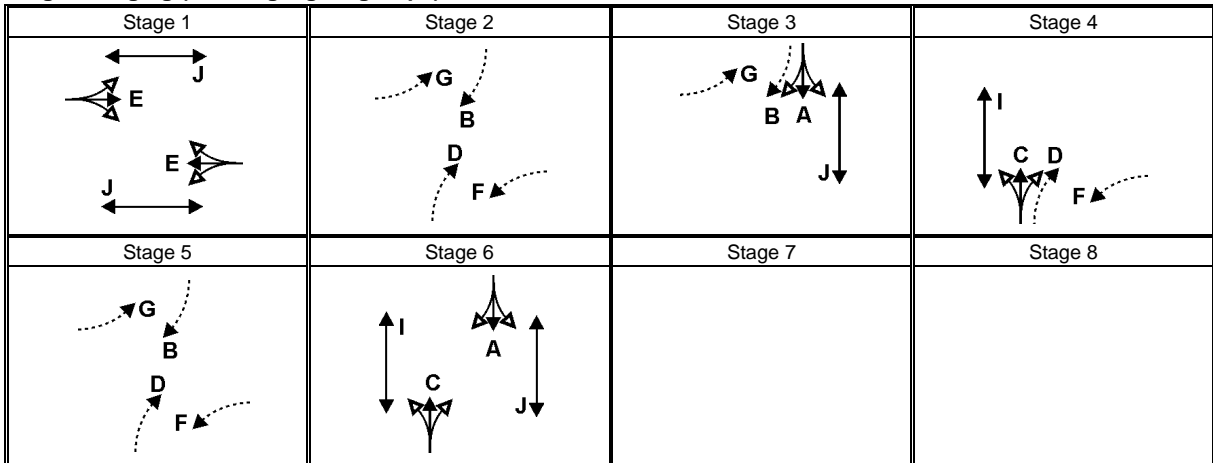

Notes – Stage 1 should be selected as the first permanently available stage, preferably on the main road.  
 Stages given and numbered in the sequence they will be displayed.

|              |              |      |             |  |
|--------------|--------------|------|-------------|--|
|              | DESIGNED BY  |      | APPROVED BY | N/S Street<br>&<br>E/W Street<br><br>Junction No: NNNN |
|              | Signed       |      | Signed      |  |
|              | Name         |      | Name        |  |
|              | Position     |      | Position    |  |
| Registration | Registration | Date | Date        |  |

Figure 6.8a: Example signal timing diagram - Signal groups and staging

Signal group and stage data

Signal group [SANS phase] data (defining safety minimum green, yellow and all-red intervals)

| Signal group | Phase type | Green delay | Min green/<br>Ped green | Yellow/<br>Flash man | Min all-red | P<br>N | Signal group conflict monitoring |   |   |   |   |   |   |   |   |   |   |
|--------------|------------|-------------|-------------------------|----------------------|-------------|--------|----------------------------------|---|---|---|---|---|---|---|---|---|---|
|              |            |             |                         |                      |             |        | A                                | B | C | D | E | F | G | I | J | K |   |
| A            | Main       | -           | 7,0                     | 3,0                  | 1,0         |        |                                  |   |   | X | X | X |   |   |   |   | X |
| B            | RT         | -           | 5,0                     | 3,0                  | 1,0         |        |                                  |   | X |   |   |   | X |   |   |   | X |
| C            | Main       | -           | 7,0                     | 3,0                  | 1,0         |        |                                  | X |   |   | X |   |   |   |   |   | X |
| D            | RT         | -           | 5,0                     | 3,0                  | 1,0         |        | X                                |   |   |   | X |   |   |   |   | X | X |
| E            | Main       | -           | 7,0                     | 3,0                  | 2,5         |        | X                                | X | X | X |   | X | X | X |   |   |   |
| F            | LT         | 3,0         | 5,0                     | 3,0                  | 1,0         |        | X                                |   |   | X |   |   |   |   |   | X | X |
| G            | LT         | 3,0         | 5,0                     | 3,0                  | 1,0         |        |                                  |   | X |   |   | X |   |   |   | X | X |
| I            | Pedestrian | -           | 5,0                     | 5,0                  | 5,5         |        |                                  | X |   | X |   |   |   |   |   |   |   |
| J            | Pedestrian | -           | 5,0                     | 5,0                  | 5,5         |        |                                  |   | X | X | X |   |   |   |   |   |   |
| K            | Pedestrian | -           | 5,0                     | 8,0                  | 5,5         |        | X                                | X | X | X |   |   |   |   |   |   |   |

Phase types: Main, Left-turn, Right-turn, Pedestrian, Cyclist  
 Green delay used to provide additional all-red interval (e.g. on slipways)  
 P/N: Green starts or ends with Previous or Next intergreen period

X In conflict

Interstage times and stage to stage movements

| From Stage | To stage |     |     |     |     |     |   |   |
|------------|----------|-----|-----|-----|-----|-----|---|---|
|            | 1        | 2   | 3   | 4   | 5   | 6   | 7 | 8 |
| 1          | X        | 5,5 | 5,5 | 5,5 | 5,5 | 5,5 |   |   |
| 2          | 5,5      | X   | X   | X   | X   | 4,0 |   |   |
| 3          | 5,5      | X   | X   | 5,5 | X   | 4,0 |   |   |
| 4          | 5,5      | X   | X   | X   | X   | 4,0 |   |   |
| 5          | X        | X   | X   | X   | X   | 4,0 |   |   |
| 6          | 5,5      | X   | X   | X   | X   | X   |   |   |
| 7          |          |     |     |     |     |     |   |   |
| 8          |          |     |     |     |     |     |   |   |

Detector data

| Detector Unit No | Signal group | Extension time (sec) | Latch call (Y/N) | Call delay (s) |
|------------------|--------------|----------------------|------------------|----------------|
| 1                | A            | 0,0                  | N                |                |
| 2                | B            | 3,0                  | N                |                |
| 3                | A            | 3,0                  | N                |                |
| 4                | C            | 0,0                  | N                |                |
| 5                | D            | 3,0                  | N                |                |
| 6                | C            | 3,0                  | N                |                |
| 7                | E            | 0,0                  | N                |                |
| 8                | E            | 3,0                  | N                |                |
| P1               | I            |                      | N                |                |
| P2               | J            |                      | N                |                |
| P3               | K            |                      | N                |                |

Stage selection (programming) When no demand revert to stage 1

| Stage | Select stage when demand detected by | Extended by |
|-------|--------------------------------------|-------------|
| 1     | 7 or 8 or P2                         | 8           |
| 2     | 2 and 5                              | 2 or 5      |
| 3     | 2                                    | 2           |
| 4     | 5                                    | 5           |
| 5     | 2 or 5                               | 2 or 5      |
| 6     | 1 or 3 or 4 or 6 or P1 or P2         | 3 or 6      |
| 7     |                                      |             |
| 8     |                                      |             |

OR = Stage selected when demand detected at ANY of the detector units  
 AND = Stage selected when demand detected at ALL of the detector units  
 NOT = Stage selected when NO demand detected at ALL of the detector units

Pedestrian push button call delay indicates the time buttons must be pressed to register demand



|  |              |  |              |  |  |  |
|--|--------------|--|--------------|--|--|--|
| <br>Consulting Engineer | DESIGNED BY  | <br>Responsible Authority | APPROVED BY  | N/S Street<br>&<br>E/W Street<br><br>Junction No: NNNN |  |  |
|  | Signed       |  | Signed       |  |  |  |
|  | Name         |  | Name         |  |  |  |
|  | Position     |  | Position     |  |  |  |
|  | Registration |  | Registration |  |  |  |
| Date   |              | Date   |              |  |  |  |

Figure 6.8b: Example signal timing diagram - Signal group and stage data

Signal plans and timings

Event table

| Day of week      | Start time | End time | Plan No | Offset Stage 1 |
|------------------|------------|----------|---------|----------------|
| Monday to Friday | 00:00      | 07:00    | 1       | N/A            |
| Monday to Friday | 07:00      | 09:00    | 2       | 12             |
| Monday to Friday | 09:00      | 16:00    | 4       | 9              |
| Monday to Friday | 16:00      | 18:00    | 3       | 15             |
| Monday to Friday | 18:00      | 24:00    | 1       | N/A            |
|                  |            |          |         |                |
|                  |            |          |         |                |

Fallback Plan No 2

| Day of week | Start time | End time | Plan No | Offset Stage 1 |
|-------------|------------|----------|---------|----------------|
| Saturday    | 00:00      | 08:00    | 1       | N/A            |
| Saturday    | 08:00      | 14:00    | 4       | 24             |
| Saturday    | 14:00      | 24:00    | 1       | N/A            |
| Sunday      | 00:00      | 24:00    | 1       | N/A            |
|             |            |          |         |                |
|             |            |          |         |                |

Signal plans and timings

| Plan No | Mode              |           | Stage 1 | Stage 2 | Stage 3 | Stage 4 | Stage 5 | Stage 6 | Stage 7 | Stage 8 | Cycle length |
|---------|-------------------|-----------|---------|---------|---------|---------|---------|---------|---------|---------|--------------|
| 1       | Fully VA          | Min green | 13,0    | 7,0     | 7,0     | 7,0     |         | 10,0    |         |         |              |
|         |                   | Max green | 40,0    | 25,0    | 25,0    | 25,0    |         | 40,0    |         |         |              |
|         |                   | Perm/Skip | S       | S       | S       | S       |         | S       |         |         |              |
| 2       | Linked fixed time | Min green | 30,0    | 10,0    |         |         |         | 25,0    |         |         | 80,0         |
|         |                   | Max green | 30,0    | 10,0    |         |         |         | 25,0    |         |         | 80,0         |
|         |                   | Perm/Skip | P       | P       |         |         |         | P       |         |         |              |
| 3       | Linked fixed time | Min green | 22,0    |         | 35,0    |         |         | 28,0    |         |         | 100,0        |
|         |                   | Max green | 22,0    |         | 35,0    |         |         | 28,0    |         |         | 100,0        |
|         |                   | Perm/Skip | P       |         | P       |         |         | P       |         |         |              |
| 4       | Linked semi-VA    | Min green | 25,0    |         |         |         | 8,0     | 22,0    |         |         | 70,0         |
|         |                   | Max green | 25,0    |         |         |         | 8,0     | 34,0    |         |         | 70,0         |
|         |                   | Perm/Skip | P       |         |         |         | S(1)    | P       |         |         |              |
| 5       |                   | Min green |         |         |         |         |         |         |         |         |              |
|         |                   | Max green |         |         |         |         |         |         |         |         |              |
|         |                   | Perm/Skip |         |         |         |         |         |         |         |         |              |
| 6       |                   | Min green |         |         |         |         |         |         |         |         |              |
|         |                   | Max green |         |         |         |         |         |         |         |         |              |
|         |                   | Perm/Skip |         |         |         |         |         |         |         |         |              |
| 7       |                   | Min green |         |         |         |         |         |         |         |         |              |
|         |                   | Max green |         |         |         |         |         |         |         |         |              |
|         |                   | Perm/Skip |         |         |         |         |         |         |         |         |              |
| 8       |                   | Min green |         |         |         |         |         |         |         |         |              |
|         |                   | Max green |         |         |         |         |         |         |         |         |              |
|         |                   | Perm/Skip |         |         |         |         |         |         |         |         |              |
| 9       |                   | Min green |         |         |         |         |         |         |         |         |              |
|         |                   | Max green |         |         |         |         |         |         |         |         |              |
|         |                   | Perm/Skip |         |         |         |         |         |         |         |         |              |
| 10      |                   | Min green |         |         |         |         |         |         |         |         |              |
|         |                   | Max green |         |         |         |         |         |         |         |         |              |
|         |                   | Perm/Skip |         |         |         |         |         |         |         |         |              |

Modes: Fixed time, Linked fixed time, Fully-VA, Semi-VA, Linked semi-VA.

P = Permanent, S= Skip stage  
(Linked semi-VA: Extend stage number)



|   |              |   |              |                               |
|---|--------------|---|--------------|-------------------------------|
|  | DESIGNED BY  |  | APPROVED BY  | N/S Street<br>&<br>E/W Street |
|   | Signed       |   | Signed       |                               |
|   | Name         |   | Name         |                               |
|   | Position     |   | Position     |                               |
|   | Registration |   | Registration | Junction No:                  |
| Date  | Date         | NNNN  |              |                               |

Figure 6.8c: Example signal timing diagram - Signal plans and timings



## CHAPTER 7: VEHICLE-ACTUATED CONTROL

### 7.1 INTRODUCTION

- 1 There are a number of different modes whereby traffic signals can be controlled. The most common modes are:
  - (a) Fixed time control in which the sequence and duration of each phase is the same in each cycle (in one timing plan).
  - (b) Vehicle-actuated control in which the appearance and, in the case of vehicular phases, the duration of each phase is dependent upon demands input from vehicle detectors and pedestrian push buttons.
  - (c) Traffic adaptive and responsive control in which the duration of each phase is determined using on-line optimisation models. Traffic adaptive control employs relatively simple models for this purpose, while models that are more complex, are used in traffic responsive control systems.
- 2 Vehicle-actuated signals allow signal indications to vary in accordance with the actuation of vehicle detecting devices. Signal intervals are self-adjustable according to real time traffic demand, within certain limits.
- 3 Vehicle-actuated signals can provide considerable savings in delay when compared to fixed time signals at remotely located (isolated) junctions. However, they tend to increase the number of stops on actuated approaches.

### 7.2 APPLICATION OF VEHICLE-ACTUATED CONTROL

- 1 Vehicle-actuated control can provide very efficient traffic operations under specific circumstances. Vehicle-actuated control performs best at remotely located, isolated junctions where traffic arrivals tend to be random. Fixed time control is less effective at isolated junctions where it cannot readily adapt to vehicle arrivals.
- 2 Vehicle-actuated control tends to become ineffective in signalised networks where traffic arrivals are cyclic. Efficient traffic control of a network involves not only the control of individual junctions within the network, but also the effective integration of junctions into a co-ordinated system. This will ensure the smooth flow of traffic through the network and minimises stop-and-go cycles. Under these conditions, fixed time control is more suitable than actuated control.
- 3 Vehicle-actuated control can, however, be incorporated into a linked co-ordinated system by providing a common cycle length as a background cycle, so that side-street demands do not interfere with progression along the main street. A vehicle on the side street may only place a demand for a green interval during a predetermined time "window". Any unused green on side-street phases can be transferred to the arterial. Linked vehicle-actuated control can provide benefits on arterial streets, but is less effective in more involved networks.

### 7.3 STRATEGIES OF VEHICLE-ACTUATED CONTROL

- 1 In vehicle-actuated control, signal timings are varied according to the presence of traffic flows, making optimum use of green times to serve phases only when there is a demand. Different actuated control strategies have been developed, but all with the same objective, **to keep the junction busy and to eliminate idle green time, thus minimising delay to vehicles.**
- 2 One strategy of actuated control is the **volume-density** controller, which has the ability to calculate the duration of green based on actual demand. It also has the feature that intergreen intervals can be adjusted according to actual speeds, thereby reducing lost time during the intergreen.
- 3 The **basic vehicle-actuated control strategy** is commonly used in South Africa. The objective of this strategy is to improve operations with a control strategy which is simple and robust to implement. The lengths of the intergreen intervals are established as for fixed time control and only the green periods are varied.
- 4 The basic vehicle-actuated control strategy attempts to minimise delay by extending green phase only for the duration queues are present on approaches receiving green. A green period that has been terminated before a queue has been served will result in a queue being cut off too early. The overflow of vehicles can only be discharged in subsequent greens, which increases delay. If the next green phase is again too short, the queue will grow, causing excessive delay (the signals are oversaturated).
- 5 However, should a too long green period be provided, it would result in lost efficiency every time that the departure flow rate drops below the maximum saturation flow rate. Such maximum saturation flow rate is normally only achievable when there is a queue of vehicles on an approach. The delay on approaches receiving a red signal increases while approaches receiving green light signals are operating at low levels of efficiency.
- 6 The method used to detect the end of a discharging queue is by searching for a gap between two vehicles. A long gap would normally only appear after a queue has discharged, thus indicating that the queue has departed. A gap is found if no further vehicles are detected over a certain distance, called the detection area, as illustrated in Figure 7.1.

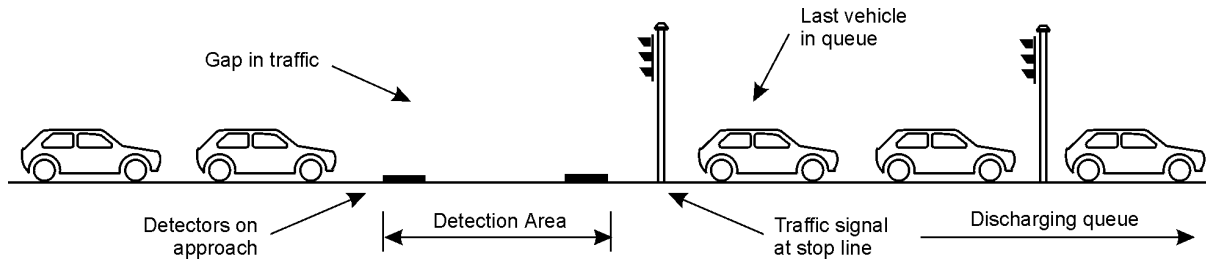

Figure 7.1: Searching for gaps in the traffic stream

## 7.4 FULLY- AND SEMI-ACTUATED CONTROL

### 7.4.1 General

- 1 Detectors on all the lanes or approaches to a junction are not always needed. If detectors are used only on some lanes or approaches, it is referred to as semi-actuated control. In fully-actuated control, detectors would normally be used on all lanes or approaches.
- 2 Fully-actuated control allows for the extension of all green intervals provided at a signal. This mode of control finds primary application at isolated junctions since it cannot be co-ordinated with other signals without losing the flexibility for which it was designed.
- 3 Semi-actuated control is used to call and extend only a subset of phases at a traffic signal, such as a right-turn or the side-street phase. Semi-actuated control can also be used in a linked or co-ordinated signal system.

### 7.4.2 Fully-actuated control

- 1 *Fully-actuated control* allows for the extension of all green phases provided at a traffic signal.
- 2 In a fully-actuated signal, the controller displays a particular signal stage, usually on the main road, for a minimum period of time (minimum green), after which it “rests” in this stage until a demand for a right of way change is detected.
- 3 The maximum green timer is started at the time a demand for a right of way change is detected. If the current minimum green timer has not elapsed, the controller waits for minimum green to terminate. The controller then waits for a gap in the traffic, subject to the maximum green interval timer.
- 4 Once a gap is detected or the maximum green expires, the signals are changed to a new stage by the controller (a “gap change” occurs if this is due to a gap in the traffic stream). The full logic is repeated for the next signal stage.

### 7.4.3 Semi-actuated control (isolated)

- 1 *Semi-actuated control* can be used at isolated junctions or in linked co-ordinated signals systems. At isolated junctions, it would normally operate with a variable cycle length, and there is no need to transfer any time saved during one stage to another stage.
- 2 In such a system, the main street is usually favoured and the main street green phase is always provided. The main street receives a minimum duration of green, after which it “rests” in this green until a demand for a right of way change is detected on either a right-turn lane or on a side street.
- 3 The controller only switches to green after a minimum time period, to allow for the accumulation of a number of vehicles on stopped approaches before a green light signal is provided.
- 4 The duration of the right-turn or side-street green is either fixed, or extendible up to a maximum interval. Once a gap is detected, or maximum green has expired, right of way reverts back to the major street, and the operations are repeated.

### 7.4.4 Semi-actuated control (linked)

- 1 *Linked semi-actuated control* is used in co-ordinated signal systems in which a fixed cycle length must be maintained, while a window of minimum green must be guaranteed for the main road.
- 2 This can be achieved by allowing the signal to operate according to a fixed time plan. At the termination of a particular signal stage, demands for other stages are examined.
- 3 If no such demand was detected, stages can be skipped. If a demand was detected, a green interval is provided which is either of fixed duration or extendible between minimum and maximum limits.
- 4 Any unused green time is allocated to other stages as specified (usually the main stage), whether or not it is actually required by such a stage.
- 5 In allocating spare green time to other stages, care must be taken to ensure that the window of minimum green is maintained on the main road.

## 7.5 MINIMUM AND MAXIMUM GREEN

### 7.5.1 Minimum green

- 1 Minimum green is the minimum time the green light signal must be displayed, measured from the instant it appears, irrespective of the demand for a right of way change.
- 2 The minimum green is provided to allow for the following:
  - (a) Absolute minimum green times required for safety (refer to Chapter 3 of this manual).
  - (b) If pedestrian signals are provided, sufficient time for pedestrians to enter and clear the junction (refer to Chapter 4 of this manual).
  - (c) Clearance of vehicles waiting between the vehicle detectors and the stop line. The tendency in most installations is not to leave any space between the detectors and the stop line (at least not longer than 1 or 2 vehicles that can be accommodated by the safety minimum green). Where such space is provided, the minimum green would depend on the number of vehicles waiting, starting lost time and saturation flow.

### 7.5.2 Maximum Green

- 1 Maximum green is used to terminate a running green light signal irrespective of the extension period in order to prevent vehicles receiving red light signals from waiting indefinitely because of a continuous stream of traffic on the running green signal. Timing of the maximum green interval commences as soon as a demand is recorded for a right of way change.
- 2 Under low and medium traffic flow conditions, a maximum green interval of between 30 to 60 seconds (or approximately 40 seconds) is normally provided at fully-actuated controlled signals.
- 3 Under heavy traffic volumes, for example during peak periods, the green period may run successively to maximum, giving in effect, fixed time operation. Under such conditions, the value of maximum green may therefore be determined as for fixed time signal control (refer to Chapter 6 of this manual).

## 7.6 STAGE REVERSION

- 1 When no demand is detected for a signal phase, the traffic signal should revert to a nominated stage and "rest" in this stage. The following options are available:
  - (a) **Rest in main green.** The signal rests in the main signal phase. No need exists to detect the presence of vehicles on the approaches served by this phase and only extension detectors may be required.
  - (b) **Rest in the last requested green (nil revert).** The controller rests in the last green in the absence of demand. All approaches must be equipped with calling detectors.
  - (c) **Rest in all-red.** The signal reverts back to red light signals on all approaches in the absence of demands. Right of way is provided on a "first come - first serve" principle.

- 2 The advantage of the "rest in all-red" method is that the lost time due to the intergreen period is reduced. The controller can quickly switch to green when a vehicle is detected on any approach, which allows the approaching vehicle to drive through the junction without having to stop. There is, however, the danger that this may result in unsafe driver behaviour since drivers may become accustomed to a green signal when arriving at the junction.
- 3 The "rest in the main green" has the advantage that green is provided on the street with the highest traffic volume. This is often the preferred method of control, but care should be taken that a series of green signals are not displayed along a road, which could encourage speeding.

## 7.7 VEHICLE DETECTION

### 7.7.1 Detection devices

- 1 A wide range of detecting devices have been developed for use in vehicle-actuated control. The inductive loop detector is currently most widely used in modern traffic control systems. Details of inductive loop detectors are given in Chapter 20 of this manual (Volume 3).
- 2 Inductive loops may operate in one of two modes, namely passage and presence modes. Presence detectors are used to indicate the presence of a vehicle on the detector, while passage detectors are used to indicate that a vehicle has crossed a loop and no indication is given of the time the vehicle has spent on the loop. Passage detectors are normally used for counting traffic while presence detectors are used for the detection of vehicles at vehicle-actuated traffic signals.
- 3 Two sets of detectors are used at vehicle-actuated controlled junctions, namely **extension** and **calling** detectors, although detectors can be used to serve both functions. Extension detectors are primarily used to extend a green period, while calling detectors are primarily used to detect the presence of vehicles waiting at red light signals.

### 7.7.2 Extension detectors

- 1 Extension detectors are used to extend a green period until a gap is found in the traffic stream. The extension detectors, however, can also be used to register the presence of vehicles waiting at red light signals.
- 2 A variety of extension detectors have been used in the past, ranging from single detectors to so-called large area detection configurations.
- 3 The ideal (but unpractical) method of extending green is by using a single large detector on the approach to a signal. Green is extended for the length of time a moving vehicle remains in the detection area (subject to maximum limits).
- 4 In practice, it is difficult to provide large area detection. Long loops tend not to have adequate sensitivity, with the result that the detectors can miss vehicles. The loops also require more maintenance, and are especially vulnerable during road works.

- 5 Large area detection can, however, be emulated by installing a multiple of short loops. *Extension intervals* are provided which allow vehicles to travel from loop to loop without green being terminated. The extensions are designed for a vehicle travelling at a low speed, but not necessarily for the slowest vehicle. This has the advantage that a vehicle travelling at a very slow speed will not extend the green for an unreasonable long time.
- 6 Although multiple loop detectors are used, these detectors can all be connected to one electronic circuit to extend the same green interval (subject to a maximum limit that can be accommodated by the electronic circuit).
- 7 Extension detectors should preferably have a diamond or parallelogram shape. These shapes are more effective in detecting fast moving vehicles. Rectangular loops can also be used for the purpose of extending green, but are less effective when vehicles are travelling at higher speeds.
- 6 The problem of vehicles stopping before or beyond the detector can also be addressed by using a detector over a longer distance, operating in **non-latching** mode. Detectors of up to 4 m or longer may be required for this purpose. The exact size and position of the detectors should be determined by observing the positions where vehicles typically stop at a junction. The size and position should be such that few vehicles would stop before or beyond the detector or detectors. Speed is of no concern, and rectangular shaped detectors can therefore be used for detecting stopped vehicles.
- 7 A further problem with operating detectors in latching mode occurs on undivided approaches where encroachment of right-turning vehicles from opposing approaches could result in the placement of false calls. This problem can be reduced by using skewed detector loops. Alternatively, a **delay** of a few seconds can also be introduced before the presence of a vehicle is actually registered.

### 7.7.3 Calling detectors

- 1 Calling detectors are required to detect the presence of vehicles waiting at red signals. These detectors are normally located at or near the *stop line* to reduce the possibility that vehicles become trapped on a red signal when they stop beyond the detector.
- 2 The stop line calling detector can also serve as an extension detector. This, however, is not very efficient since a green interval is extended after the vehicle has already entered the junction. When separate extension detectors are provided at a junction, the stop line calling detectors should NOT be used to extend the green interval.
- 3 Where calling detectors are used to place a call for the same green interval, all such detectors can be connected to one electronic circuit (subject to a maximum limit that can be accommodated by the electronic circuit).
- 4 Care should also be taken to place the calling detector at a position where most vehicles would stop on the detector to reduce the probability of vehicles either stopping before or beyond the detector. Such vehicles will not be detected and could wait for a long time for a green signal.
- 5 The problem of vehicles becoming trapped beyond the calling detector can be addressed by placing the detector in **latching** (or locking) mode. In this mode, the call of the vehicle is held after it has passed the detector. The loops normally have a parallelogram (or diamond) shape to detect vehicles crossing at high speed. This method has the disadvantage that when a vehicle passes without stopping, it would place a false call for a stage that is not required.

## 7.8 DETECTOR CONFIGURATIONS

### 7.8.1 General

- 1 A number of example detector configurations that can be used at vehicle-actuated signals are shown in Figures 7.2 to 7.5.
- 2 The configuration given in Figure 7.2 can be used when only a right-turn phase is actuated, while those shown in Figures 7.3 to 7.5 can be used when different types of phases are actuated, such as left-turn, right-turn and main signal phases.
- 3 Care should be taken when applying the examples. Although the examples could probably be used in many applications without modification, there may be specific conditions that would necessitate deviations from the configurations.

### 7.8.2 Detector configuration for protected/permitted right-turn phases

- 1 The detector configuration shown in Figure 7.2 can be used when a **protected/permitted right-turn phase** is actuated and no actuation is provided for any other phases on the approach. Such a configuration would be operating in a semi-actuated mode of control.
- 2 Only one detector is used on the right-turn lane as both a calling and extension detector. Two possible locations are shown for the detector, depending on whether a leading or lagging phase is provided.
- 3 The detector positions shown in Figure 7.2 have been determined based on the assumption that one or two vehicles can turn right during the main-phase intergreen period. The presence of a second or third waiting vehicle would be the warrant for the separate right-turn phase.



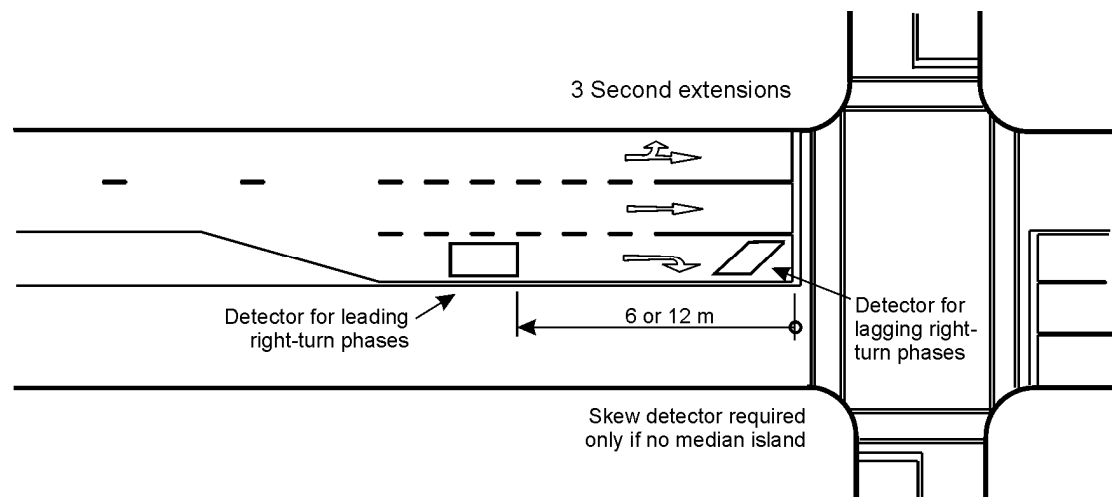

Figure 7.2: Right-turn detector configuration

- 4 Leading right-turn phases require the following detector configuration:
  - (a) The detector should be placed some distance before the stop line since vehicles are stopped on the approach to the junction. A distance of about 6 m can be provided for each vehicle to be skipped (6 m for one vehicle and 12 m for two vehicles). A shorter distance is used at narrower junctions and a longer distance at wider junctions.
  - (b) A detector with a length of about 4 m is generally recommended. Openings between stopped vehicles are seldom more than 4 m and a detector of such length is required to reduce the possibility of vehicles not being detected.
- 5 Lagging right-turn phases require the following detector configuration:
  - (a) Detectors should be provided at or near the stop line since it can be assumed that the first one or two right-turn vehicles are waiting within the junction and not on the approach to the junction. The design of the right-turn detector is then similar to that of other stop line detectors.
  - (b) A delayed-call detector is sometimes used to place a call only if a vehicle is continuously detected beyond a pre-set period of, for example, 5 seconds. This allows the controller to ignore moving vehicles and to accept calls only from stopped vehicles. Care should, however, be taken when using this facility since the fact that a vehicle is moving is not necessarily an indication that there is no longer a right-turn queue.
- 6 The assumptions made in determining the detector positions shown in Figure 7.2 are not valid (and the configuration can therefore not be used) under the following circumstances:
  - (a) When a protected-only right-turn phase is provided.
  - (b) In fully-actuated systems where provision is made for the skipping of the main signal phase.
 In both these cases it can not be assumed that the first one or two vehicles will be able to turn right during the main phase intergreen, and stop line calling detectors must be provided to detect the presence of these vehicle.

### 7.8.3 Single stop line detector configuration

- 1 The single stop line detector configuration shown in Figure 7.3 can be used for the actuation of different types of signal phases (main, left-turn and/or right-turn). This configuration is the simplest available and use is made of only one set of detectors at the stop line. These detectors serve as both calling and extension detectors.
- 2 The disadvantage of this configuration is that green intervals are extended when vehicles have already entered the junction. Each time a gap change occurs, 3 seconds of green may be lost in **addition** to the duration of the intergreen period. This reduces the efficiency of the configuration.

#### 7.8.4 Double detector configuration

- 1 A more efficient configuration is shown in Figure 7.4 in which two sets of detectors are provided, the one used for calling purposes and the other for extension purposes. The extension detectors are set back from the stop line with the result that green extensions are given while a vehicle is still approaching the junction, and not within the junction itself.
- 2 The configuration shown in Figure 7.4 is designed for a speed of 40 km/h. When a vehicle exceeds this speed, some green time will still be lost (although not substantial). A vehicle travelling at 60 km/h only requires about 2 seconds to travel the distance between the extension detectors and the stop line, while a 3 second extension interval is provided. The 1 second lost time is a significant improvement over the lost time of 3 seconds of the single detection system.
- 3 A problem with the configuration in Figure 7.4 is the use of the high design speed of 40 km/h. Many queues of vehicles only depart at a speed of between 20 and 30 km/h, particularly when turning at a junction. A vehicle travelling at a speed of 20 km/h would require approximately 6 seconds to reach the stop line while green is extended for only 3 seconds. It is therefore possible that this vehicle would stop on yellow and not utilise the green extension. This problem can be addressed by the triple detector configuration.

#### 7.8.5 Triple detector configuration

- 1 The triple detector configuration utilises one set of calling and two sets of extension detectors as shown in Figure 7.5. The advantage of the triple detector configuration is that vehicles can be better tracked as they travel over the detection area.
- 2 The configuration shown in Figure 7.5 is designed for a speed of 20 km/h between the first two sets of extension detectors and 30 km/h between the extension detectors and the stop line.
- 3 The triple detector configuration has a slightly lower lost time than the double detector configuration, but the improvement is not significant. The advantage of the triple detector configuration is that it accommodates slower vehicles better than the double detector configuration. A slow vehicle travelling at 20 km/h will be able to reach the second extension detector with the 2 second extension given by the first extension detector. The same vehicle requires slightly more than 3 seconds to reach the stop line, and will therefore arrive at the stop line 1 second after the onset of yellow. Most drivers would not stop at the junction under such circumstances.

#### 7.9 PEDESTRIAN DETECTION

- 1 When designing vehicle-actuated traffic signals, it is important that not only the needs of vehicular traffic are taken into account, but also those of pedestrians (and pedal cyclists).
- 2 When provision is made at a signal to skip a vehicular phase that operates parallel with a pedestrian phase, push buttons should be provided for the actuation of the phase. A call for the phase can be placed by the pedestrian, even if no vehicles are then present to actuate the phase.

#### 7.10 BIBLIOGRAPHY

- 1 DOE (Department of the Environment, UK), 1973, Siting of inductive loops for vehicle detecting equipment at permanent road traffic signal installations, Specification MCE 0108A.
- 2 Kruger, P., 1990, The Efficient Control of an Isolated Vehicle-Actuated Controlled Intersection: A comparison between Queue Control and Volume-Density Control, Institute of Transportation Studies, Report UCB-ITS-RR-90-1, Berkeley, pp.1-66.
- 3 Webster, F.V. and Cobbe, B.M., 1966, Traffic Signals, Road Research Technical Paper No. 56, London, Road Research Laboratory.

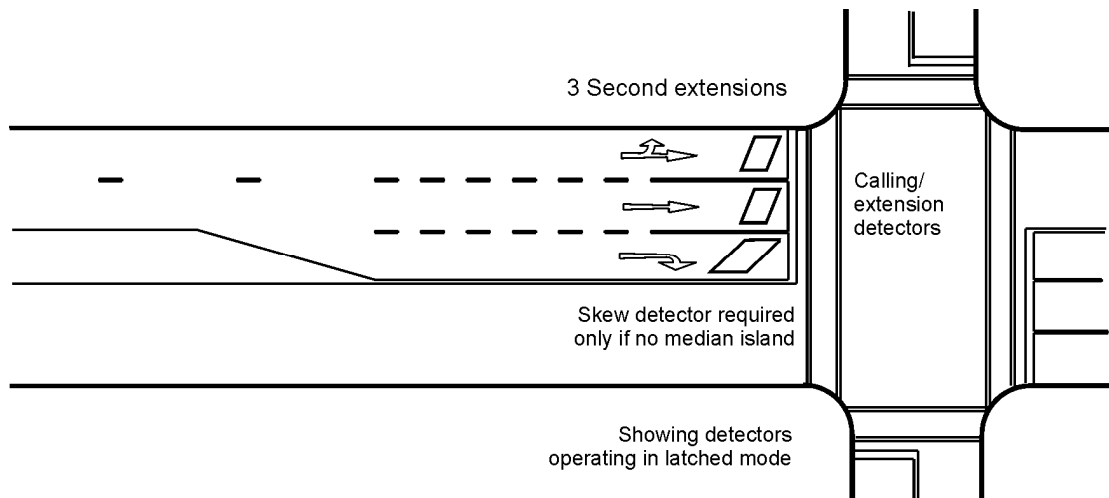

Figure 7.3: Single stop line detector configuration

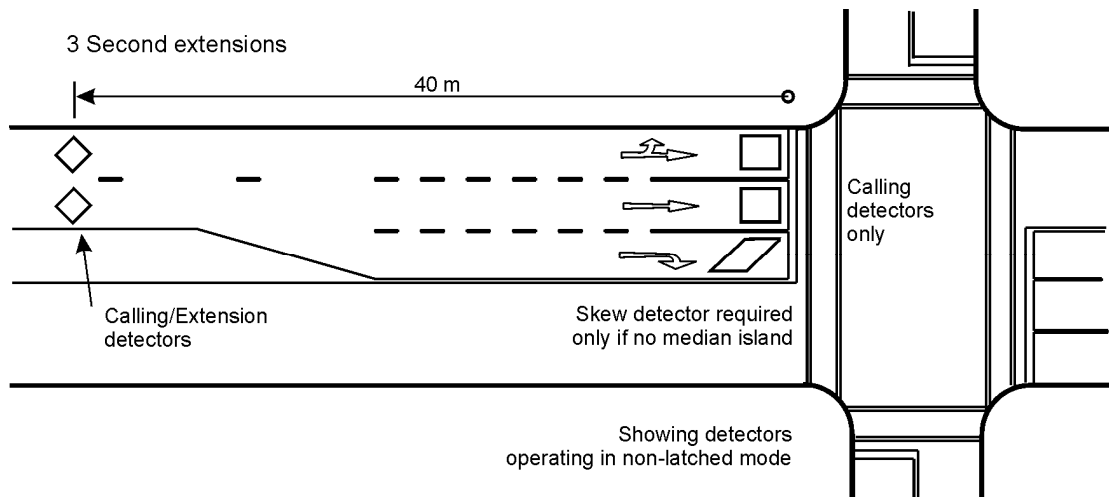

Figure 7.4: Double detector configuration (design speed 40 km/h)

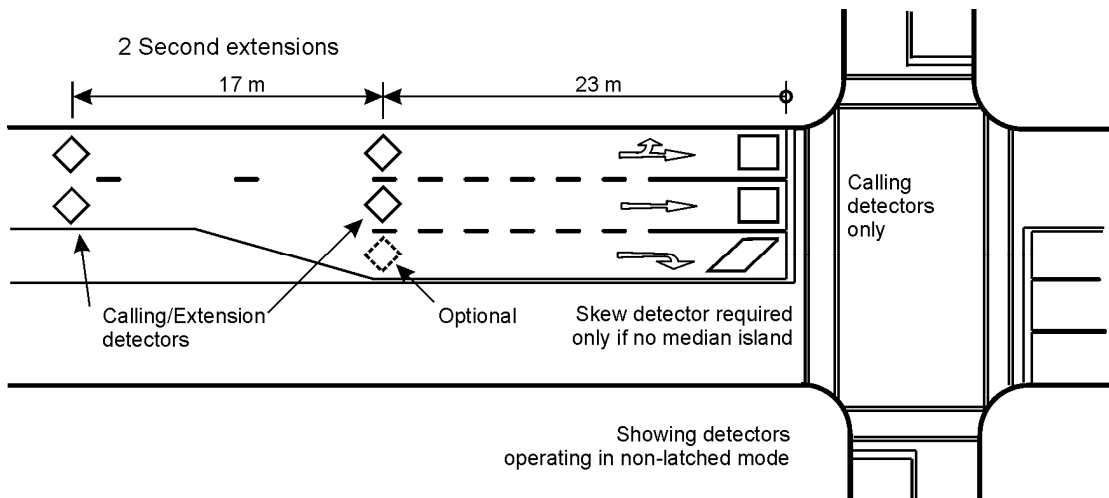

Figure 7.5: Triple detector configuration (design speed 20/30 km/h)



## CHAPTER 8: VEHICLE-RESPONSIVE CONTROL

### 8.1 INTRODUCTION

- 1 Vehicle-responsive control at isolated junctions utilises a self-optimising strategy in which green periods are adjusted based on the calculation of a control function or performance index. The objective is to establish signal settings that optimise the performance index. This performance index could either be delay, or a combined function of delay and number stops. Traffic is counted by means of loop detectors, and traffic models are used to calculate the performance index for alternative signal settings.
  - 2 The control strategy used in vehicle-responsive control differs from that used in vehicle-actuated control. A relatively simple strategy is used in vehicle-actuated control that would just allow the longest queue to pass through a junction on green. Actuated control, however, has a number of shortcomings that result in less than optimum control. This strategy is relatively successful when traffic flows are low, but actuated control tends to run to maximum when flows are high, resulting in less efficient or even oversaturated operations. Vehicle-responsive control would be able to optimise signal settings under both low and high traffic volumes.
  - 3 The method of control described below is the one used in the MOVA (Microprocessor Optimised Vehicle Actuation) controller developed by the Transport Research Laboratory (TRL) in the United Kingdom. The method combines both vehicle-actuated and traffic responsive strategies and utilises the advantages of both strategies in one system. Traffic responsive control requires relative accurate measurements of traffic volumes. An accumulation of small errors in traffic counts can result in less than optimum operations. This problem can be addressed by combining the vehicle-actuated and traffic responsive control strategies.
  - 4 MOVA is claimed to reduce vehicular delay significantly in comparison with vehicle-actuated control, and that it addresses many of the shortcomings of vehicle-actuated-control. An advantage of the system is that a microprocessor-based module has been developed which can be added to many existing traffic signal controllers. Consequently, it is not necessary to replace existing controllers.
- 3 A basic decision is made to establish whether the junction is under or oversaturated. The junction is deemed to be undersaturated if queues clear the junction each cycle. When a substantial number of vehicles remain in the queue at the end of green, the junction is oversaturated. Different control strategies are used depending on whether the junction is undersaturated or oversaturated.
  - 4 In the undersaturated condition, the duration of the green period is determined by making a number of sequential decisions based on traffic and queue information obtained from the vehicle detectors. The following control strategies are then implemented:
    - (a) The green period starts with the implementation of a basic **vehicle-actuated** control strategy in which provision is made for the following:
      - (i) An absolute minimum green followed by a further variable green that allows for vehicles stopped between the X-detector and the stop line. The variable green is estimated from a count of those vehicles that have crossed the X-detector during the preceding red period.
      - (ii) After the minimum green interval, the size of the "gap" between successive vehicles is measured at the X-detectors to determine if traffic is discharging at measurably less than the saturation rate. As soon as *one* lane of an approach is judged to be discharging at less than full rate, then the entire approach is judged to have reached the "end of saturation" condition. When *all* relevant approaches have individually reached end of saturation then the end of saturation is deemed to be reached.
    - (b) Once end of saturation has been reached and queues have departed, a **traffic responsive control** strategy is implemented in which provision is made for the following:
      - (i) A traffic model is used which is updated from IN- and X-detector counts. This model is used to calculate the benefit or disbenefit of extending the current green period. The benefit or disbenefit is determined as the saving in the performance index.
      - (ii) A check is maintained of all vehicles that will benefit and disbenefit from extending the green. The vehicles that will benefit are those that are receiving green, while vehicles that will disbenefit are those that are queuing at red signals around the junction. Traffic that is expected to arrive in the short-term future is also taken into account.
      - (iii) If the performance index falls to zero or below, the decision is made to change the signals. If the performance index is positive, the current green is extended.

### 8.2 CONTROL PRINCIPLES

- 1 The MOVA system uses detectors located in each lane at typically 100 m and 40 m from the stop line as shown Figure 8.1. The detector located at 100 m from the stop line is defined as the IN-detector. The detector at 40 m is defined as the X-detector.
- 2 Different forms of control strategies are implemented depending on traffic flow conditions. The duration of the green interval is determined by making a number of sequential decisions based on traffic flows and queue information derived from the vehicle detectors.

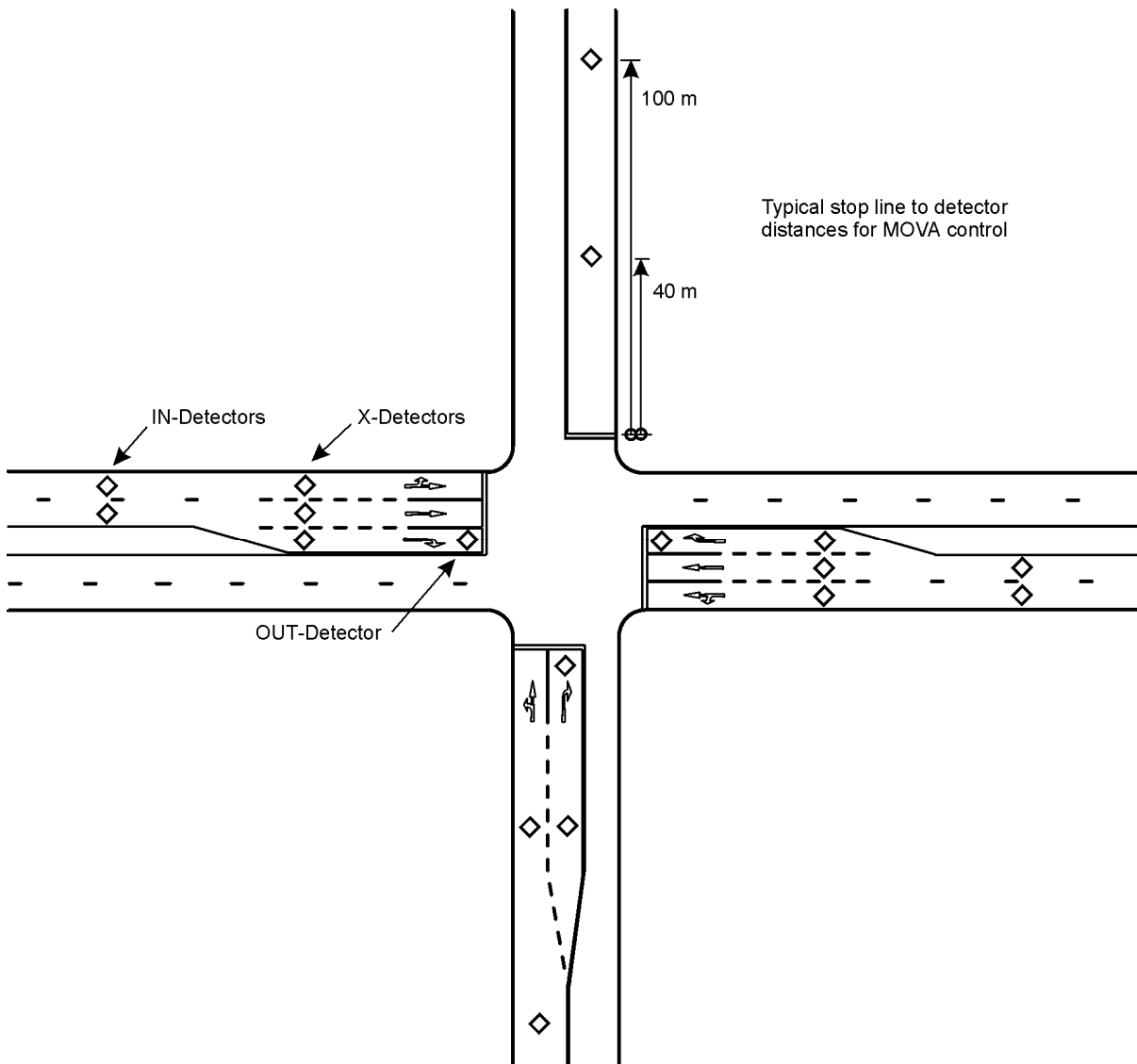

Figure 8.1: Typical layout of detectors

- 5 In the oversaturated condition, a control strategy is implemented which attempts to maximise capacity on congested (oversaturated) approaches. Green is maintained on oversaturated approaches provided that discharge continues at full saturation up to pre-set maximum greens. The junction will then operate on long cycles; thus minimising lost time.
- 6 Provision is also made for deciding whether or not an exclusive right-turn phase is required. If this facility is to be used an additional detector is required in advance of the stop line. This is referred to as the OUT-detector (see Figure 8.1). Traffic counts are used from both the OUT- and X-detectors. Should this number exceed a pre-set minimum, the exclusive right-turn phase is provided.
- 7 The combination of the various control strategies makes this an effective method of control. Although obviously more costly than fixed time control, the benefits to traffic and not having to update signal timings regularly, outweighs the cost substantially.

### 8.3 BIBLIOGRAPHY

- 1 Vincent, RA and Pierce, JR, 1988, "MOVA": Traffic Responsive, Self-Optimising Signal Control for Isolated Intersections, Research Report 170, Traffic Management Division, Traffic Group, Transport and Road Research Laboratory, Crowthorne, Berkshire, UK.
- 2 Vincent, RA and Pierce, JR and Webb, PJ, 1990 "MOVA" Traffic Control Manual, Application Guide 10, Traffic Management Division, Traffic Group, Transport and Road Research Laboratory, Crowthorne, Berkshire, UK.
- 3 Highways Agency, Traffic Systems and Signing, December 1999, Installation Guide for MOVA, MCH 1542, Issue B, Highways Agency.

## CHAPTER 9: AREA TRAFFIC CONTROL

### 9.1 INTRODUCTION

- 1 The co-ordination of traffic signal controlled junctions is highly beneficial to the flow of traffic through a network of traffic signals or along an arterial road. The major objective in co-ordinating traffic signals is to permit continuous flow of traffic through such a network. A co-ordinated system will significantly reduce vehicular delays and stops with commensurate savings in number of accidents, fuel consumption, levels of air pollution, etc.
- 2 Signals at different junctions can be co-ordinated by using a common signal cycle length and a set of signal offsets that determine relative time relationships between adjacent signals. The use of a common cycle length synchronises the signals and assures that the relative timings of the signals will be repeated regularly.
- 3 Traffic signals can be particularly effective when co-ordinated in a network, compared to isolated control. In a network, traffic flow patterns are typically relative stable, strongly platooned and cyclic. Under such conditions, it is possible to achieve a relatively high level of efficiency. On the other hand, these same conditions can have exactly the opposite impact if signals are not properly co-ordinated. Operations can become extremely inefficient in an unco-ordinated traffic signal system.
- 4 Modern area traffic control systems utilise a central computer for storing and implementing traffic signal plans. This was made possible by the rapid development in computer technology and telecommunications. These systems have grown in sophistication and are commonplace in most major cities throughout the world.
- 5 There are numerous methods of implementing traffic signal co-ordination, ranging from the very simplistic through to real time traffic responsive control. All of these methodologies fall under the collective term of Area Traffic Control (ATC). The following systems are discussed in this chapter:
  - (a) Master signal control
  - (b) Fixed time area traffic control
  - (c) Adaptive area traffic control
  - (d) Traffic responsive area traffic control

### 9.2 MASTER SIGNAL CONTROL

- 1 A relatively simple method of co-ordinating traffic signals in a small signal network or on an arterial is by utilising a local master controller. This master controller is used to synchronise local controllers in the system.
- 2 The implementation of local master-slave co-ordination is shown in Figure 9.1 and requires the following equipment:
  - (a) A specifically designated master controller (this may be separate or it may double as a standard signal controller).
  - (b) Slave controllers at each road junction and signalised pedestrian crossing.
  - (c) A pilot cable connecting each of the slave controllers to the master.
- 3 The pilot cable is utilised for the transmission of information to affect timing plan changes, and to maintain synchronisation and co-ordination of the controllers.

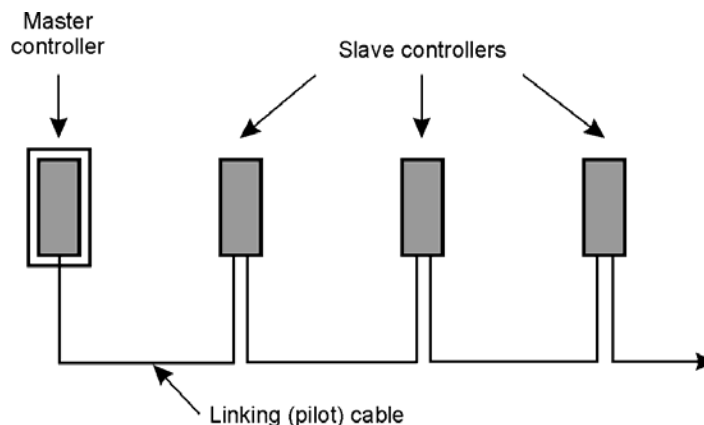

Figure 9.1: Schematic for linking co-ordinated signals

### 9.3 FIXED TIME AREA TRAFFIC CONTROL

- 1 The simplest form of area traffic signal control is by means of a fixed time system. Plan preparation is undertaken off-line and plan selection can occur by time of day or using automatic plan selection methods.
- 2 Automatic plan selection provides an area control system with the ability to introduce fixed time plans in response to detector inputs. A plan may be introduced on the basis of inputs such as the following:
  - (a) A count detector exceeding a threshold (either the absolute value or the rate of change in the traffic count).
  - (b) A queue detector detecting a long queue.
  - (c) An occupancy detector exceeding its threshold.
- 3 Plans can be selected by means of Boolean logical expressions or a method whereby each plan is allocated a priority based on the detector inputs. Transitional plans can be provided to allow the controller to step up or down towards the required signal plan.
- 4 Fixed time area control has the disadvantage that signal plans must be prepared manually. These plans must also be updated regularly to reflect changing traffic conditions, which require costly data collection and analysis. Automatic plan selection improves the flexibility of the system, but does not reduce the need for the manual and regular updating of plans.

### 9.4 ADAPTIVE AREA TRAFFIC CONTROL

- 1 Adaptive and responsive control systems have been developed with the objective of overcoming shortcomings of fixed time control systems. Such systems can react automatically to changes in traffic conditions on the road network.
- 2 Adaptive traffic control utilises simpler control strategies than the traffic responsive systems described in the next section. Although simpler, adaptive control can provide relative efficient traffic signal control.
- 3 The adaptive strategy described below is the one used in the SCATS system (Sydney Co-ordinated Adaptive Traffic System). This system was developed by the Road and Traffic Authority of New South Wales in Australia.
- 4 The system utilises stop line detectors for the collection of traffic flow data. A detector loop is placed in each lane approaching a junction as shown in Figure 9.2. Some lanes, however, can be left without any detectors.

- 5 The stop line detectors are used to estimate the *degree of saturation* for each lane approaching a junction. This degree of saturation is estimated as used green divided by total available green. Used green is taken as the number of vehicles crossing the detector multiplied by the average saturation flow headway. These degrees of saturation are used to optimise traffic signal timings as follows:
  - (a) Cycle lengths are established based on the degree of saturation. A target cycle length is selected, and the actual cycle length changed in steps of a few seconds in the direction of the target cycle length. A large step size is used when there is a steep change in traffic demand.
  - (b) Green splits are established that will result in equal degrees of saturation on critical lanes.
  - (c) Signal offsets are undertaken on a selection basis. A number of offsets can be provided for each link, and the system selects the offset most suitable to the level of traffic flow on the link. The offsets are calculated off-line (as for fixed time plans).
  - (d) Signal phases can be defined, and any phase for which no traffic demand has been registered, may be skipped.
- 6 The SCATS system has been extensively developed and tested, and a variety of refinements have been developed to ensure reliable operation. The system has demonstrated its value compared to fixed time control and is particularly effective when responding to unpredictable traffic patterns. Being traffic adaptive, the need for regular updating of signal settings is obviated.

### 9.5 TRAFFIC RESPONSIVE CONTROL

- 1 Traffic responsive control systems utilise a relatively complex traffic model for the on-line estimation of a performance index and establishment of optimum traffic signal settings. The system is therefore self-optimising, and can respond to changes in traffic patterns and flows.
- 2 The control strategy described below is the one used in the SCOOT system (Split, Cycle and Offset Optimisation Technique). This system was jointly developed by the Transportation Research Laboratory and three prominent traffic signal companies in the United Kingdom.
- 3 The system utilises detectors that are located some distance upstream of the stop line as shown in Figure 9.3. Traffic flows measured at these detectors are used to predict a traffic arrival profile at the downstream stop line using platoon dispersion models. An example of such a projected stop line demand profile is shown in Figure 9.4.
- 4 Predetermined saturation flows are used to estimate queue lengths from which delays and number of stops can be calculated. A performance index is determined as the weighted sum of delay and number of stops. This index is recalculated every few seconds from the latest traffic flow measurements, and is used to establish optimum cycle length, green splits and signal offsets.
- 5 The upstream detectors also have the added advantage that queues extending back to the detectors can be detected, which allow appropriate actions to be taken to avoid blocking of junctions.



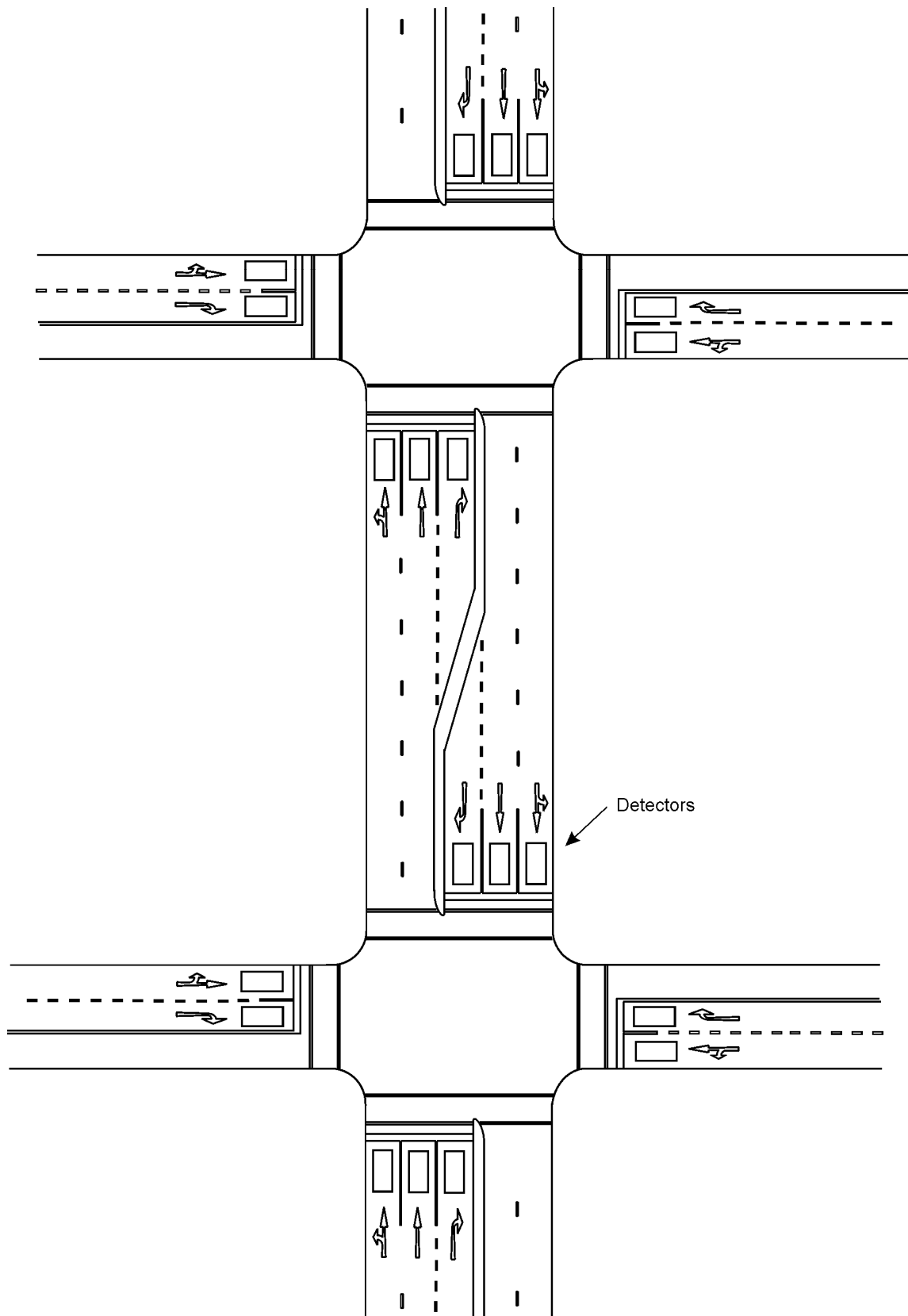

Figure 9.2: Adaptive traffic control vehicle detector layout

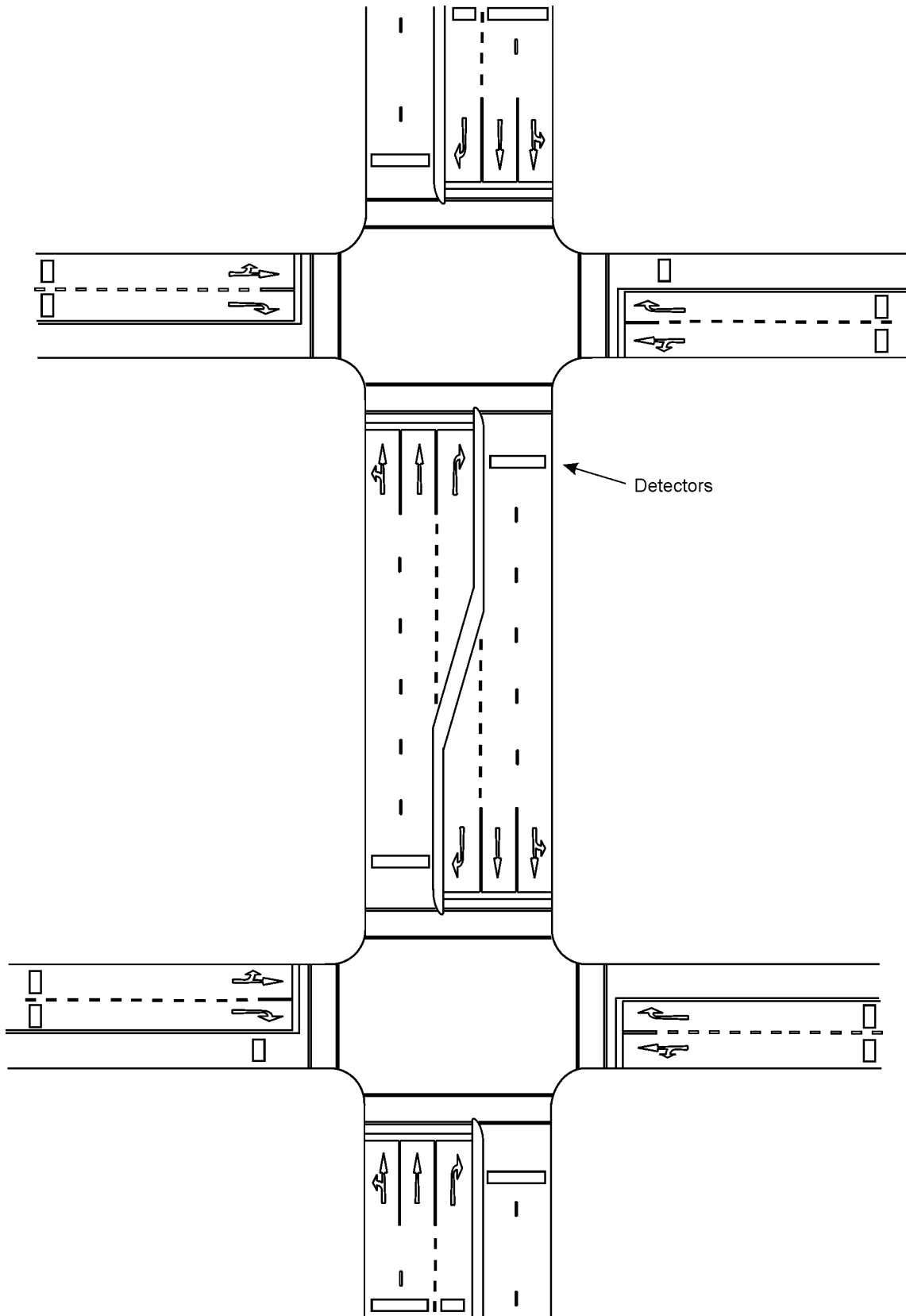

Figure 9.3: Traffic responsive control vehicle detector layout

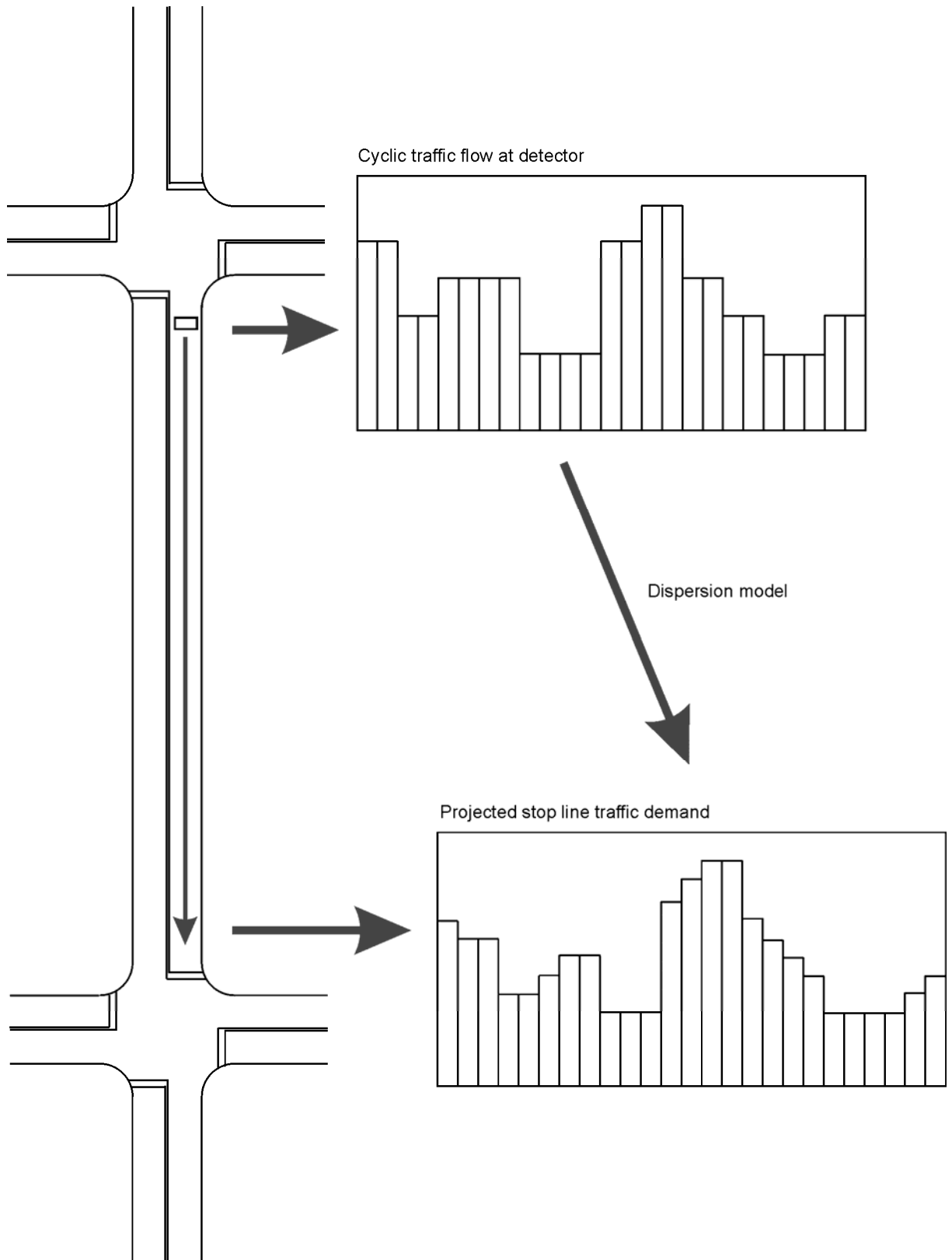

Figure 9.4: Projected traffic demand profile at downstream junction

- 6 The optimisation process is continued throughout the day. During low flow conditions, a shorter cycle length is used. The cycle length is increased gradually during periods of high traffic flow. Green splits are also adjusted based on flow patterns.
- 7 The SCOOT model requires a minimum number of basic parameters that are stored in a database. These parameters include the following:
  - (a) A network description in the form of nodes, links and detectors that must be coded according to prescribed rules. During this process, detectors are associated with links and links associated with downstream links and signal phases.
  - (b) The free-flow journey times from upstream detectors to downstream stop lines.
  - (c) The discharge rate from the stop line in Link Profile Units (LPU's). This is similar to saturation flow and is a critical parameter in the system that is determined during validation.
  - (d) Timetables which specify which signal plans should be operative and at what time of the day, day of week etc. Provision is usually made for a full year calendar to allow for public and school holidays.
- 8 On completion of the data preparation, a validation process is undertaken to ensure that the model accurately represents what is happening on the street network. Specific software is available to assist with this process. This should preferably be undertaken using a mobile computer and GSM connection to the instation computer. The importance of this validation process cannot be overemphasised.

## 9.6 BENEFITS OF ADAPTIVE AND RESPONSIVE SYSTEMS

- 1 There is a significant learning curve before systems such as SCATS and SCOOT can be used with confidence. Experience has, however, shown that the rewards in using these systems exceed the effort.
- 2 Field evaluations have shown that both systems can provide significant savings in fuel consumption, journey time and stops over and above conventional fixed time plans. These savings are further purported to increase significantly when compared with fixed time plans that have not been updated for a number of years.
- 3 Figure 9.5 shows the flexibility of traffic adaptive or responsive control compared to fixed time. There is a limit to the number of fixed time plans that can be developed, with the result that a plan must be utilised over a period of time during which the plan may not necessarily be optimal. In Figure 9.5, a total of six timing plans have been used over a period of 12 hours, and even these are not adequate to cope with the varying traffic demand. A traffic adaptive or responsive control system is able to respond to actual traffic demand in real time.
- 4 Definitive comparisons between SCOOT and SCATS have not been possible due to the divergent loop placement philosophies. Both systems provide positive benefits compared with fixed time operation and as is the case with many systems, both have their advantages and disadvantages.

- 5 Most cities in South Africa have opted for the SCOOT system. The need to share knowledge and experience with peers is an important motivation why preference can be given to the SCOOT system. However, when skilled manpower is available, there is no reason why the SCATS system or other systems cannot be considered.

## 9.7 DATA ACQUISITION BENEFITS

- 1 An added benefit of a traffic responsive system is the opportunity provided for acquiring traffic data for purposes other than traffic signal control. Due to the communication capabilities of such systems, it is also possible to collect traffic data in real time.
- 2 The data collected for the purposes of traffic responsive signal control are not perfectly accurate. It is, however, possible to develop adjustment factors based on traffic data collected by other means, such as automatic counting stations. These factors are used to improve the accuracy of the traffic data collected by the traffic responsive system.
- 3 The traffic data collected as part of the traffic signal control system can be utilised in a variety of applications. These applications are not only limited to those that are of value to the traffic engineer, but can also be of benefit to the public.
- 4 An important possible application for which such data can be utilised is the determination of congestion levels. The SCOOT system in fact allows for the direct estimation of vehicular delays at individual signals. Such information is available in real time and can form part of a driver information system in which information is provided on quickest available routes to destinations. Various methods of communication can be used for this purpose, such as computer networks or radio broadcasts.
- 5 The traffic data are useful in many traffic engineering applications outside traffic signal design. Such information can, for instance, be utilised for the production of traffic flow maps in which traffic volumes are indicated by bands of variable width. Such flow maps can be particularly useful in the overall planning of a road and street network.
- 6 The above data acquisition benefits of traffic responsive systems should be taken into account when a road authority is considering the introduction of such a system.

## 9.8 BIBLIOGRAPHY

- 1 Siemens Traffic Control Systems, March 1996, SCOOT Traffic Handbook : SCOOT 3.1, Siemens Traffic Controls Ltd, Poole, UK.
- 2 Hunt P.B. and Robertson, D.I. 1982, SCOOT – A traffic responsive method of co-ordinating signals, Department of Transport, TRRL Report LR 1014, Crowthorne.
- 3 Lowrie, P.R., 1982, The Sydney Co-ordinated Adaptive Traffic System – Principles, Methodology, Algorithms, Department of Main Roads, N.S.W, Australia.
- 4 Sims A.G. and Finlay A.B. 1984, SCATS, Splits and offsets simplified, ARRB Proceedings Vol 12, Part 4.

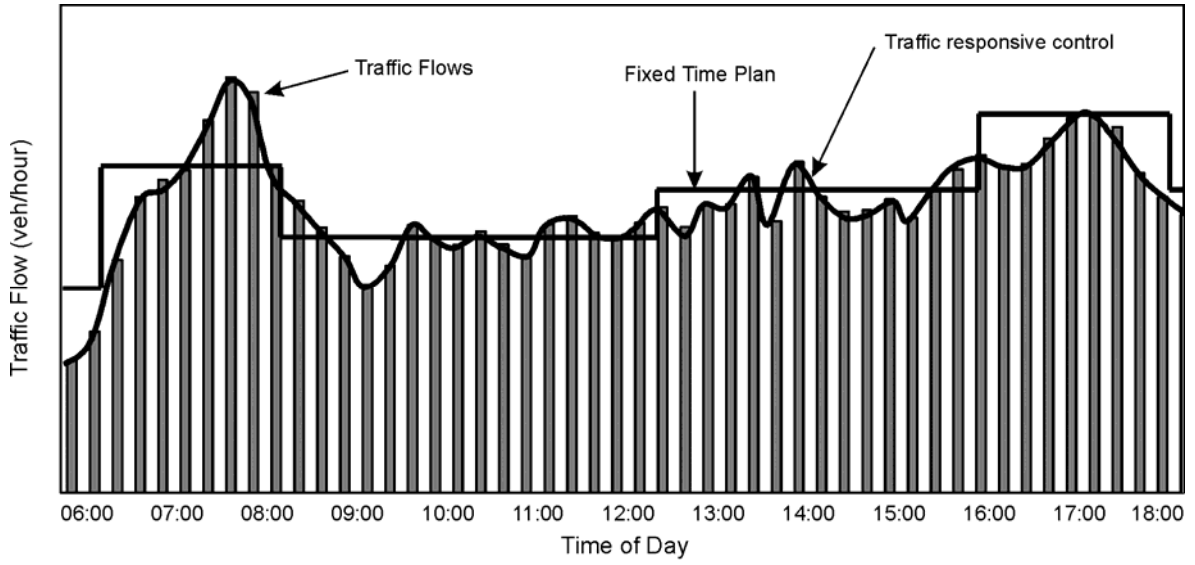

Figure 9.5: Flexibility of traffic responsive control



## CHAPTER 10: VEHICLE PRIORITY

### 10.1 INTRODUCTION

- 1 Priority can be given at signalised junctions to certain classes of vehicles. These typically include emergency and public transport vehicles.
- 2 Emergency vehicles, such as fire engines and ambulances, can be given priority to reach areas of distress in the event of a major emergency. In such cases, a continuous band of green would be provided for emergency vehicles. For minor emergencies, these vehicles would typically use their sirens to obtain priority.
- 3 Public transport vehicles can be given priority when it is desired to make public transport more attractive to passengers by reducing travel time. Under priority control, buses could travel under green wave conditions, whether or not this applies to other vehicles on the same route. This enables them to more easily maintain their schedules and also to reduce travel times.
- 4 The provision of priority control must be justifiable through actual time savings that can be achieved. For public transport vehicles, such time savings should ideally be of such a magnitude that there would be a modal switch from passenger cars to public transport with a concomitant reduction in congestion.
- 5 Priority control does not require the use of special signals and can be applied to any configuration of signals at any junction. Use can, however, be made of bus or tram signals in situations where lanes are reserved for buses or tram rails are provided.

### 10.2 DETECTION OF VEHICLES

- 1 A major problem in the application of priority control is establishing the time of arrival at any given junction. The arrival time of buses, for instance, is determined primarily by the time spent by passengers boarding or alighting at bus stops. Their arrival at any given junction thus tends to be random and a fixed time type of control is correspondingly impossible to apply.
- 2 Priority control therefore requires the detection of vehicles as they are approaching a junction. This can be done by means of devices installed in (or alongside) the roadway or onboard the vehicles.
- 3 The devices that can be installed in the roadway include inductive loops, pneumatic pads, piezo-electric detectors, etc. The electronic "signatures" of vehicles are used to differentiate between different vehicle classes.
- 4 The more satisfactory method is onboard transponders for communication with a central control system. Use is made of an antenna that is either embedded in the road surface, or mounted alongside or above the road to detect priority vehicles. Information is relayed to a centralised computer, which initiates whatever priority action is contained within its algorithm.

- 5 Detectors or antennas have to be installed sufficiently far upstream to allow for initiation of the priority strategy. It follows that bus stops cannot be permitted between the site of the detector and the junction.

### 10.3 PRIORITY STRATEGIES

- 1 Various priority strategies can be considered. An example is to provide a green phase on the approach as soon as the priority vehicle is detected. However, this cannot be done immediately, and the normal sequence of yellow and all-red light signals must be provided on non-priority approaches. A "pre-emption" or "hurry call" facility must be available in the controller to implement this strategy.
- 2 If a priority vehicle is approaching a green light signal, priority would also involve providing a sufficiently long extension of the phase to allow the vehicle to safely clear the junction.
- 3 Pre-emption and priority control can also be exercised at non-junction locations such as at approaches to one-lane bridges, work sites and metered freeway on-ramp terminals.
- 4 Some of the above strategies can be provided in traffic responsive control strategies. For emergencies, some form of interaction would be required to initiate specific signalisation plans to cope with the emergency. Other strategies would be based on the automatic detection of priority vehicles.





## CHAPTER 11: INDIVIDUAL VEHICLE CONTROL SIGNALS

### 11.1 OPERATION

- 1 Traffic signals for the control of individual or single vehicles, as distinct from those that give right of way to groups of vehicles, are used to control traffic at locations such as freeway on-ramps, toll booths and roadside checkpoints.
- 2 The Type S12 traffic signal face is used for the control of individual vehicles as shown in Figure 11.1. The signal face comprises only a RED DISC and a GREEN DISC LIGHT SIGNAL.
- 3 A yellow signal aspect is not provided in the S12 signal face. The signals should therefore not be used to control vehicles other than those that are stationary or travelling at low speed. This can be achieved by:
  - (a) displaying the green signal only to a vehicle that has already stopped at a stop sign, or other similar sign, near to the signal (such as at toll booths and checkpoints); or
  - (b) resting the signal in red and displaying the green signal ONLY when required, and then only for a few seconds to allow one stopped vehicle to depart at a time (such as when ramp metering is applied).
- 4 Where it is required to give continuous right of way to all approaching vehicles, the green light signal may be displayed continuously. When it is necessary to switch the signal to red, a flashing red light signal should first be displayed for a duration of at least 5 seconds.
- 5 At no time SHALL an operational traffic signal be intentionally switched off and blacked out, other than for maintenance or repairs or when controlled by a traffic officer or an authorised pointsman. Flashing red light signals may also be used to indicate that the signals are out of order.

### 11.2 TOLL BOOTHS AND CHECKPOINTS

- 1 The S12 traffic signal face is used at toll booths and checkpoints to instruct vehicles either to stop or to continue.
- 2 A STOP sign R1, or any other sign that instructs the driver to stop, should be displayed at the stopping point. At least one S12 traffic signal face should then be provided per lane of traffic, located on the right-hand (driver's) side of the lane. The signal face should be located not less than 6 m beyond the stop position.
- 3 The signal should wherever possible, be controlled automatically. The duration of the green light signal and change to red can best be controlled by the output from vehicle detectors in each lane. The illumination of the green light signal may be performed automatically, e.g. linked to a toll booth cash register, or manually.

### 11.3 RAMP METERING

#### 11.3.1 General

- 1 Ramp metering is applied to restrict the number of vehicles allowed to enter a freeway in order to ensure an acceptable level of service on the freeway or that the capacity of the freeway is not exceeded. The need for ramp metering may arise due to factors such as:
  - (a) Recurring congestion because traffic demand exceeds the capacity of roads in an area.
  - (b) Sporadic congestion on isolated sections of a freeway because of short-term traffic loads from special events, often of a recreational nature.
  - (c) As part of an incident management system to assist in situations where an accident downstream of the entrance ramp causes a temporary drop in the capacity of the freeway.
- 2 Ramp metering should, however, be considered a last resort rather than a first option in securing an adequate level of service on the freeway. Prior to its implementation, all alternative means of improving the capacity of the freeway or reducing the traffic demand on the freeway should be explored.

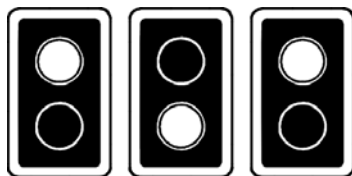

S12 traffic signal face

Figure 11.1: Single vehicle release operating sequence

- 3 Installation should be preceded by an engineering study of the physical and traffic conditions on the freeway facilities likely to be affected. These facilities include the ramps, the ramp terminals and the local streets likely to be affected by metering as well as the freeway sections involved.
- 4 The study should include the establishment of desirable metering rates. The effect of metering rates on the level of service on the freeway as well as the street network should be evaluated. Attention should be given to storage requirements on ramps and the possible impact of queues on local streets.
- 5 A problem with ramp metering is the need for law enforcement. Without enforcement, infringement rates can be expected to be high. If, for any reason, it is not possible to ensure regular enforcement, ramp metering should not be considered.
- 6 When ramp metering is in operation, the S12 signals should normally rest in red, and a green light signal displayed ONLY when required and then only for the time required by the departing vehicle to clear the line of vision of the signal face. Such timing should preferably be achieved by means of vehicle detectors. At least two detectors would normally be required for this purpose, namely the check-in and check-out detectors, as shown in Figure 11.2.

### 11.3.2 Installation

- 1 The stop line should be placed well in advance of the point at which ramp traffic will enter the freeway to allow vehicles to accelerate to approximately the operating speed of the freeway, as would normally be required for the design of on-ramps.
- 2 It will also be necessary to ensure that the ramp has adequate storage to accommodate the vehicles queuing upstream of the traffic signal.
- 3 The above requirement will almost certainly lead to a need for reconstruction of any ramp that is to be metered. The lengths of on-ramps are typically determined by the distance required to enable a vehicle to accelerate to freeway speeds. Without reconstruction, this could result in the ramp metering signal actually being installed at the ramp terminal.
- 4 A STOP LINE RTM1 shall be provided on the on-ramp. At least two S12 traffic signal faces should be provided for ramp metering at a distance not less than 6 m (preferably not less than 10 m) beyond the stop line.
- 5 A FLASHING YELLOW WARNING SIGNAL SS3 could, with advantage, be installed at the start of the ramp to warn vehicles that metering is in operation.
- 7 The check-in detector should be located at the position where vehicles would normally stop at the stop line. A long detector (up to 4 m or longer) would be required to cover a wide range of stopping positions. This check-in detector is used to actuate the green light signal when an approaching vehicle is detected AND a minimum red period has expired.
- 8 The check-out detector actuates the red light signal as soon as a vehicle is detected, subject to the provision of a minimum green period (from the time the vehicle is first detected and NOT when it departs from the loop). The detector must be located beyond the last traffic signal at a point where the red light signal will not be visible to the departing vehicle (about 1 to 2 m beyond the signal).
- 9 Detector loops can also be installed on the freeway itself to ensure that an adequate gap exists before the next green light signal is provided on the ramp.
- 10 A queue detector can also be used to identify the backup of traffic onto the local street system. When a queue of that length is detected, a higher metering rate may be temporarily allowed to reduce the queue to an acceptable length. This must, however, be applied with circumspection because a consistently high rate of arrivals may result in the application of a metering rate that is so high that it approaches the condition of there being, in fact, no metering at all - thus defeating the objective of installing metering in the first instance.
- 11 The highest rate of metering that can be handled by metering of a single stream of vehicles is approximately 900 vehicles per hour. This rate can be attained with about two seconds of green followed by two seconds of red. A red period shorter than 2 seconds should not be used.
- 12 A lower rate of metering can be achieved by increasing the minimum red interval. A metering rate in the order of 600 vehicles per hour will, for instance, be achieved by providing two seconds of green followed by four seconds of red.

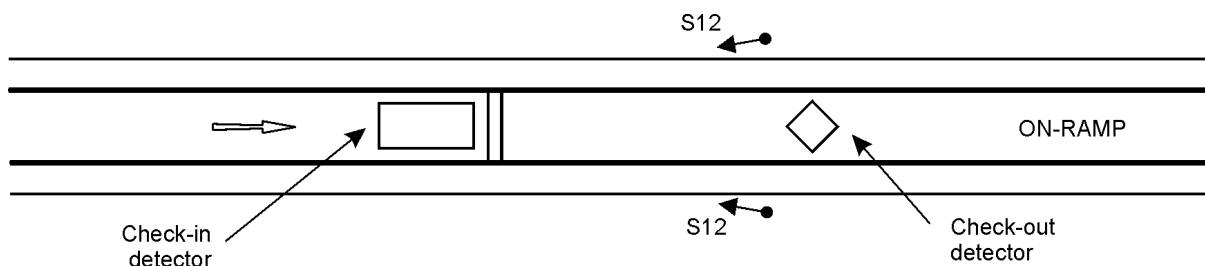

Figure 11.2: Ramp metering application of the S12 signal face

## CHAPTER 12: SIGNALS AT ROADWORKS

### 12.1 INTRODUCTION

- 1 Temporary traffic signals may be provided at roadwork construction sites for the following purposes:
  - (a) to successively give right of way to two-way traffic approaching from opposite directions, along a single traffic lane, in place of a manually operated STOP-GO sign; or
  - (b) to control the movement of traffic, including site vehicles, where a public road enters or crosses a road that is under construction, or haul road; or
  - (c) as an interim measure to control traffic where a permanent traffic signal is to be provided, altered or replaced as part of a roadworks project.
- 2 Temporary traffic signals should be installed and operated only where warranted as follows:
  - (a) at a road junction or pedestrian crossing where traffic flow and delay conditions would otherwise warrant a permanent installation; or
  - (b) where there is undue delay or danger to public traffic at the junction of a public road and a road under construction or a haul road, as a result of construction operations, provided that the overall disbenefit to public traffic does not exceed the benefit to construction traffic; or
  - (c) where the control of two-way traffic on a single traffic lane is warranted; or
  - (d) where it would otherwise be necessary to exercise manual control by means of a STOP-GO sign during hours of darkness.
- 3 Temporary traffic signals should preferably not be operated for longer periods than 6 months. If required for longer than 6 months, the installation of permanent signals should be considered.
- 4 The principles of traffic signal control at permanent installations apply equally to temporary installations. This means that the numbers and locations of signal faces, the compulsory provision of background screens (backboards), sight distances, etc. also apply to temporary traffic signals. The speed limit at the traffic signals shall also not exceed a maximum of 80 km/h.
- 5 It is recommended that three yellow retro-reflective strips be provided on the signal posts and that white retro-reflective borders be used on backboards. Temporary traffic signals are often used in locations with poor background lighting and where they may be more subject to failure than permanent signals. The signals are also often used in locations where traffic signals would not normally be expected by drivers. It is therefore important that more attention should be given to the visibility of the signals.
- 6 Precaution should be taken to ensure the uninterrupted operation of the signals, by securing them against theft and vandalism, and by providing an effective power source. Lights and plant should wherever possible be securely anchored down and cables should be buried.

- 7 Warning signs should be provided in advance, but the signs should be concealed or removed while the signals are not operative.
- 8 Details of the use of temporary traffic signals at roadworks are given in Chapter 13 of Volume 2 of the Road Traffic Signs Manual.

### 12.2 VEHICLE-ACTUATED CONTROL

- 1 Depending on the anticipated traffic pattern, a manual or a vehicle-actuated traffic control signal with temporary actuation loops is likely to be more efficient than fixed time signals.
- 2 The operation of temporary vehicle-actuated signals at junctions does not differ significantly from that of permanently installed signals, and the same principles may be applied. The only difference would be in the use of temporary detection loops. Use can also be made of microwave detectors that do not require installation of loops in or on the road surface.
- 3 Vehicle-actuated control is particularly important in the control of two-way traffic on a single lane of traffic. Loops are not only needed on the approaches to such a lane, but can also be provided on the lane with the purpose of extending the all-red period just sufficiently for vehicles to clear the lane. This type of control is discussed below.

### 12.3 TWO-WAY TRAFFIC IN A SINGLE LANE AT ROADWORKS

#### 12.3.1 General

- 1 Temporary traffic signals are often used for the control of two-way traffic in a single lane, particularly when the length of the lane is long. The signals are used to successively give right of way to the two-way traffic from opposite directions.
- 2 At least two traffic signal faces of type S1 shall be provided on a two-way single lane road at roadworks, one on each side of the road, at a position not less than 6 m (but preferably not less than 10 m) beyond the stop line RTM1. However, where the traffic signal is manually operated, only one such signal face may be provided.
- 3 The stop line must be suitably located on the wider part of the road so that opposing traffic can pass vehicles waiting at the stop line.
- 4 Portable equipment may be used in the signal installations. At least two sets of traffic signals will be required, each set consisting of:
  - (a) Signal faces mounted on a yellow post, fitted with backboards (preferably with retro-reflective borders and strips).
  - (b) A signal controller, equipped with a radio module, and if necessary a manual remote control unit.
  - (c) A set of vehicle detectors (preferably microwave detectors).
  - (d) Power pack of batteries and/or generator.
  - (e) Spare equipment, particularly spare lamps.

- 5 The controller may allow for two-phase operation only. Each side of the lane has a separate controller, one of which must be switched to “master” operation and the other to “slave” operation. The controller must provide that, in the event of failure or a loss in radio communications, the signals revert to flashing red mode.
- 6 Vehicles can be detected by means of temporary induction loops, but microwave detectors could be more appropriate. Detectors can be installed on the approaches to the single lane, and also on the lane itself. Detectors on the approaches are used for the extension of the green interval and the detection of demand, while detectors on the lane itself may be used for adjusting (extending) the all-red interval.
- 7 When the signals are located relatively close together, a cable may be used to link the two controllers. In cases where the two signals are spaced very close together, one controller can be used to drive both sets of signals.
- 8 Where the signals are located further apart, radio communication would be the more desirable method of linking the two controllers. Care should be taken that such a radio would be able to communicate reliably over the distances required.

### 12.3.2 Manual operations

- 1 The traffic signals may be operated in manual mode. For such operations, a remote control unit should preferably be provided. This remote unit can be connected to the signal controller with a cable. The use of the remote unit allows the operator to be located safely in a position where the approach is clearly visible (but preferably in a position where both approaches are visible).
- 2 In manual mode, the operator controls the duration of all-red and green intervals, but not that of the yellow interval that is predetermined. Minimum periods may be set for the green and all-red intervals. The controller must prevent green accidentally being displayed in both directions.
- 3 The operator should view both approaches and switch the signals accordingly. When this is not possible, an assistant should be provided who is in radio contact with the operator. This assistant will inform the operator when vehicles are approaching or waiting to be served at the other end of the single lane, and when the queue of vehicles has departed from the approach.
- 4 The operator should provide only sufficient green for the waiting queue of vehicles to depart from the signal, except when there is no demand at the other end of the single lane. An adequate all-red period must be provided to allow the last vehicle to exit from the single lane.
- 5 In the absence of traffic demand on any of the approaches, the operator should rest the signal in all-red. This will allow a green light signal to be provided soon after a vehicle has arrived on either side of the single lane.

### 12.3.3 Fixed time operations

- 1 In fixed time operation, green and all-red intervals are predetermined and there is no response to vehicle demands. This type of operation is not very efficient, but it has the advantage that it is less costly to operate and maintain.
- 2 In fixed time mode, the maximum 15-minute traffic demand that is likely to occur must be established and sufficient green provided. The duration of the green intervals can be established as for a normal fixed time controlled junction, except that a longer all-red period is provided.
- 3 The all-red interval should provide sufficient duration for slow moving traffic to clear the single lane before the onset of the opposing green. This should be established based on the 15<sup>th</sup> percentile free-flow speed on the lane (judgement may be required to establish whether this would be adequate). The all-red period may not be less than 2 seconds.
- 4 When sufficient sight distance is provided, a shorter all-red may be used, and a flashing red light signal provided to indicate that drivers can proceed after stopping if the way ahead is clear.

### 12.3.4 Vehicle-actuated operations

- 1 Vehicle-actuated operations allow signals to automatically respond to vehicle demands. The signals will change in response to the registered demand as vehicles actuated the detectors.
- 2 The vehicle-actuated controller will only provide green until a gap is detected on the approach, and a demand has been registered on the other side of the single lane. When a gap is detected, the signal will change to the next phase, subject to the provision of minimum green intervals.
- 3 Vehicle detectors can also be provided on the lane itself, which will allow for the adjustment (extension) of the all-red interval. These detectors should be spaced at constant distances, and an extension time provided which will allow a vehicle travelling at the 15<sup>th</sup> percentile speed to reach the next detector (and finally the stop line) within the extension time provided. A minimum all-red period equal to this extension time must be provided to allow departing vehicles to reach the first detector along the single lane. Extensions must be provided for both directions of movement.
- 4 The adjustment of the all-red interval can significantly reduce unnecessary delays when roadworks occur over long distances. Assuming a 15<sup>th</sup> percentile speed of about 12,5 m/s (45 km/h), a single lane of 1 km would require an all-red interval of about 80 seconds ( $1000 \text{ m} / 12,5 \text{ m/s} = 80 \text{ s}$ ). If the last vehicle departing from green travels at a higher speed of 20 m/s (72 km/h), only 50 seconds of travel time would be required. This would mean that vehicles would be waiting unnecessarily at the other side for 30 seconds while all vehicles have already cleared the lane.

- 5 Suppose three extension detectors are provided along the lane at 250 m distance intervals. This would require an all-red extension time of 20 seconds ( $250 \text{ m} / 12,5 \text{ m/s} = 20 \text{ seconds}$ ).
- 6 A minimum all-red period of 20 seconds is provided on termination of green. If the last vehicle to depart is travelling at a speed of 20 m/s, this vehicle would reach the first detector after 12,5 seconds, or 7,5 seconds ahead of the minimum all-red period. The first detector extends the all-red period by 20 seconds to a total of  $12,5 + 20 = 32,5$  seconds.
- 7 The vehicle reaches the second detector 25 seconds after it had left the stop line. The all-red period is extended by 20 seconds to a total of  $25 + 20 = 45$  seconds. At the third and last detector, the all-red period is extended to the final total value of  $37,5 + 20 = 57,5$  seconds.
- 8 The vehicle travelling at 20 m/s will be exiting from the lane after 50 seconds. This then means that vehicles will only wait unnecessarily for about 7,5 seconds, which is significantly less than the 30 seconds without detectors.
- 9 The above delays are directly related to the length of the single lane. A single lane of 2 km would double the delays, while a lane of 10 km would cause 10 times as much delay.
- 10 In the absence of any demand, the signals should revert to all-red, until a vehicle is detected. This feature ensures that the signals are then able to give right of way to the first approaching vehicle with minimum delay. This is a further important advantage of vehicle-actuated control.



## CHAPTER 13: LANE DIRECTION CONTROL SIGNALS

### 13.1 INTRODUCTION

- 1 Lane direction control signals are used to signalise reversal of traffic flow along a road lane to accommodate the tidal nature of traffic flow during different times of a day. The signals shall be used to *indicate the permitted direction of traffic movement along a lane of a road and to prohibit the entry of traffic into, and the movement of traffic along, that lane from the opposite direction.* In this way, right of way can be allocated alternately on a predetermined basis, to one of two possible directions of traffic movement in the lane, or lanes, so signalised.
- 2 Lane direction control signals shall ONLY be used to permit or prohibit traffic movements in situations where *at least one lane is subject to reversals* of the direction of traffic flow. If there is a need for such application, use can be made of VARIABLE MESSAGE SIGNS as described in Chapter 9 of Volume 1 of the Road Traffic Signs Manual.
- 3 The signal faces that may be used for lane direction control are the S16, S17, S18 and S19 signals shown in Figure 13.1. Permitted variants of the S16 and S17 signal faces are shown in Figure 13.2. The variants S(16)-17 and S16-(17) may be provided as variable signals where both the cross and arrow can be displayed on a single matrix.
- 4 According to the National Road Traffic Regulations, the STEADY GREEN DOWNWARD-POINTING ARROW SIGNAL S16 is used to *“indicate to the driver of a vehicle that he or she may drive his or her vehicle in the lane over which the arrow is displayed”.*

- 5 The STEADY RED CROSS SIGNAL S17 is used to *“indicate to the driver of a vehicle that he or she shall not drive his or her vehicle in the lane over which the cross is displayed and that the lane is open to vehicles travelling in the opposite direction”.*
- 6 The YELLOW LEFT AND RIGHT ARROW SIGNALS S18 and S19 are used to *“indicate to the driver of a vehicle that the lane over which the arrow is displayed is closed ahead and that he or she shall leave the lane in the direction of the arrow when it is safe to do so”.*

### 13.2 INSTALLATION

- 1 LANE DIRECTION CONTROL SIGNALS shall comprise of two independently illuminated signal aspects, Types S16, and S17. The signals SHALL be mounted in PAIRS as shown in Figure 13.3, one facing in each direction, centrally over the traffic lane subject to reversal in direction of use.
- 2 PAIRS of the lane direction control signals S16 and S17 shall be placed at the beginning and end of each lane subject to reversed flow and at intermediate points along the lane that will enable a driver to see at least two light signals at any time, the distance apart not exceeding half the minimum sight distance for urban conditions given in Table 3.1 of Chapter 3 of this manual (Volume 3).



Figure 13.1: Standard lane direction control signals

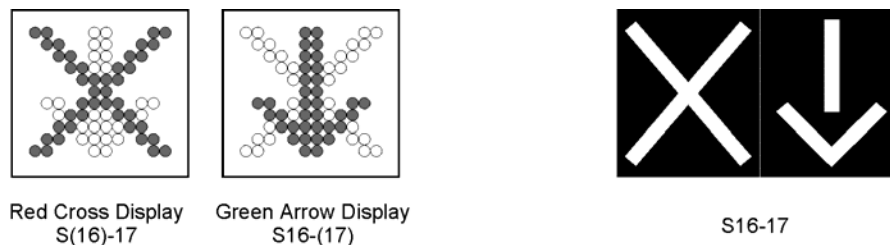

Figure 13.2: Permitted variants of lane direction control signals

- 3 It is recommended that fixed display lane direction control signals, or fixed "arrow" or "cross" signs, be placed over all OTHER lanes that are not subject to reversible traffic flow, to supplement the LANE DIRECTION CONTROL SIGNALS.
- 4 LANE DIRECTION CONTROL SIGNALS S18 or S19 may be placed in advance of the lane closure, over the centre of the lane to be closed. Signals S18 or S19 shall be operated on the basis that they are either illuminated or switched off. The signals shall be illuminated when they precede an illuminated S17 RED CROSS signal over the reversible flow lane. If it is necessary to provide a long merging distance, more than one S18 or S19 signal may be used, in sequence, over the approach lane. These signals do not have to be mounted in pairs.
- 5 The roadway signals S18 or S19 should be located in advance of the lane closure at a distance as given in Table 3.1 in Chapter 3 of Volume 1 of the Road Traffic Signs Manual. This distance should be increased in accordance with the difficulty which traffic may experience in merging with traffic in the adjacent lane.
- 6 The lane direction control signal faces are normally gantry mounted and the standards for height and clearance are the same as for other signals. The faces may NOT be mounted with the centre of the signal aspects at a height exceeding 6,2 m above the road. There shall also be a vertical clearance of not less than 5,2 m from the road to the lowest part of any light assembly or supporting structure.
- 7 Light units in South Africa shall conform to the requirements of South African standard specification SANS 1459: *Traffic lights* in regard to light output and colour value of light signals. Details of the light signals, including dimensions, are given in Chapter 10 of Volume 4 of the Road Traffic Signs Manual.
- 8 Appropriate lane markings, as described in Chapter 7 of Volume 1 of the Road Traffic Signs Manual may be used.

### 13.3 OPERATION

- 1 Reversal of the direction of traffic flow along a road lane, or lanes, can be considered where it is beneficial to make use of the tidal nature of traffic flow. Such traffic flow reversals, however, shall be used only where it can be certain that it will operate safely. The technique is not recommended for use on roads with a speed limit exceeding 80 km/h.
- 2 Careful attention should be given to capacity requirements and channelisation of traffic at each end of the lane(s) subjected to reversed traffic flows. Inadequate capacity to meet the increased directional flow will mitigate against the effectiveness of the action. Some drivers may get confused as to which lanes to use at the terminal points and extra control signals or other measures may be needed at these locations.
- 3 Traffic flow in any one direction shall be for continuous periods of not less than one hour. Changeover should preferably occur at the same time of each day of the week and when traffic volumes are not at, or near, the peak. It is recommended that there should be no more than two changeovers in one day, i.e. one period of reversed flow per day.
- 4 Prior to permitting vehicles to use a reversible direction lane, all the signals along each section shall show crosses in both directions to provide sufficient time to ensure that the traffic lane is free of moving or trapped vehicles.
- 5 Signals may be switched off when not required, provided that in such circumstances the direction of flow of traffic and the bounds of traffic lanes are obvious from other permanent road traffic signs.

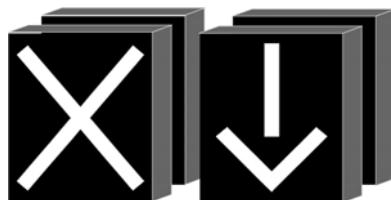

Figure 13.3: Back-to-back mounting of lane direction control signals



## CHAPTER 14: RAILWAY CROSSING SIGNALS

### 14.1 INTRODUCTION

- 1 The National Road Traffic Act permits the railway operator (Transnet Limited) to erect road traffic signs at railway crossings as they may deem expedient. However, provision is also made in the act that such operator can be directed to display or remove signs as may be required.
- 2 According to the National Road Traffic Regulations, no person shall stop a vehicle on the roadway of a public road within the railway reserve at a level crossing, except in order to avoid an accident, or in compliance with a road traffic sign or with a direction given by a traffic officer.
- 3 Due to extremely high risk of fatal and serious injury resulting from accidents at level railway crossings, it is important that the highest standard of traffic control should be provided at such crossings. This includes making drivers aware of the fact that they are approaching a level railway crossing.
- 4 Railway crossings should be marked with the rail crossing warning signs W403 or W404. Sign W403 is displayed on approaches to single railway level crossings, while sign W404 is displayed on approaches to level crossings with more than one railway line. In addition to these signs, the advance warning sign W318 can be applied with good effect, particularly under circumstances where visibility is obscured. These signs and their applications are described in Volume 1 of the Road Traffic Signs Manual.
- 5 A number of road signs may be used for the control of traffic at level railway crossings. These include the use of FLAG SIGNALS SS2 as well as STOP SIGNS R1 and YIELD SIGNS R2 singly or in combination with the W403 or W404 warning signs. The use of these road signs is described in Chapter 7 of Volume 2 of the Road Traffic Signs Manual.
- 6 FLASHING RED DISC LIGHT SIGNALS (FRD) may also be used to warn drivers that a train is approaching a level crossing. Two such signals shall be used in conjunction with a STOP SIGN R1 and a warning sign W403 or W404. The signals shall be mounted below the stop sign R1 and above the warning signs W403 or W405 as shown in Figure 14.1.
- 7 According to the National Road Traffic Regulations, the flashing red disc signal *“indicates to the driver of a vehicle that he or she shall stop his or her vehicle and shall not proceed until it is safe to do so, and such signal shall have the same significance as stop sign R1”*.

### 14.2 INSTALLATION

- 1 The flashing red light signals at railway crossings SHALL be situated on the near side of the railway crossing, on the left side of each approach roadway.
- 2 The flashing red light signals shall conform in all respects to the requirements laid down for vehicular traffic signals at road junctions and pedestrian crossings, except that:
  - (a) The signal face shall comprise a single red disc aspect and shall be mounted on the same post as the stop signs R1 and the warning signs W403 or W404.
  - (b) The red disc aspect shall be displayed only in flashing mode, as and when required to warn of the approach or presence of a train, and shall not display a steady red light signal at any time.
  - (c) Two flashing red disc signal aspects shall be provided on the same post.
  - (d) The flashing red disc signal may be accompanied by an audible signal.
  - (e) The signal posts shall be as for road signs.



Figure 14.1: Flashing red disc light signals at railway crossings

- 3 In South Africa, the signals shall comply with standard specification SANS 1459: *Traffic lights*.
- 4 The use of flashing red disc light signals will be warranted by one or more of the following conditions:
  - (a) when a crossing has a high accident history;
  - (b) sight distance requirements are not met (these requirements are given in Chapter 2 of Volume 2 of the Road Traffic Signs Manual);
  - (c) train operations involve reversals of movement across the crossing; or
  - (d) train operations occur during the hours of darkness.

### 14.3 OPERATION

- 1 The two flashing red light signals are used to indicate to a driver that he or she shall stop his or her vehicle. The preferred mode of operation is that a flashing red disc light signal is displayed at least 30 seconds before the arrival of a train. If gates or barriers protect the crossing, the flashing red light signal should start 20 seconds before the gate or barrier closes.
- 2 The two flashing red disc light signals shall be arranged to flash alternately in such a way that the alternating flashes remain constantly out of phase i.e. when one disc is fully illuminated the other disc has zero luminous intensity and vice versa.

## CHAPTER 15: HAND AND OTHER SIGNALS

### 15.1 GENERAL

- 1 This section covers a number of traffic signals that involve manual indications or other signals that are not operated electrically, and include the following:
  - (a) control hand signals for use by traffic officers SS1;
  - (b) flag signals SS2;
  - (c) flashing yellow warning signals SS3; and
  - (d) flare signals SS4.

### 15.2 CONTROL HAND SIGNALS FOR USE BY TRAFFIC OFFICERS SS1

#### 15.2.1 General

- 1 CONTROL HAND SIGNALS FOR USE BY TRAFFIC OFFICERS SS1 may be used to control the movement of traffic and/or pedestrians and as such are regulatory signals. Such signals will normally be used when some other form of traffic control is out of operation or when traffic volumes are such that special control needs to be exercised to reduce congestion and establish order, or when there is a need to stop traffic for a specific reason.
- 2 According to the National Road Traffic Regulations, **"a control hand signal SS1 shall conform to the requirements of one of the standard hand signals as shown in Figure 15.1 and shall be:**
  - (a) **a hand signal to stop traffic approaching from the front, indicating to the driver of a vehicle approaching a traffic officer from the front, who is displaying the signal, that he or she shall stop until the signal referred to in d) below is displayed;**
  - (b) **a hand signal to stop traffic approaching from the rear, indicating to the driver of a vehicle approaching a traffic officer from the rear who is displaying the signal, that he or she shall stop until the signal referred to in d) below is displayed;**
  - (c) **a hand signal to stop traffic approaching from the front and the rear, indicating to the driver of a vehicle approaching a traffic officer from the front or rear who is displaying the signal, that he or she shall stop until the signal referred to in d) below is displayed; or**
  - (d) **a hand signal to show traffic to proceed from the front, left or right, indicating to the driver of a vehicle that he or she may proceed if a traffic officer displays the signal".**
- 3 In addition to the above hand signals, the traffic officer may use other hand signals to supplement those described above. It is common practice, for instance, for a traffic officer to select the vehicle that he or she wishes to stop some distance back in a traffic stream and to clearly identify it by pointing prior to giving the appropriate hand signal. In a similar way, a traffic officer may indicate by pointing to one of several stopped streams of traffic that the vehicles in the indicated stream may proceed.

- 4 Having given a stop signal to road users the traffic officer may lower the hand used for such signal and uses it to execute other hand signals. The road users stopped by such original signal shall not proceed until directed to do so by the traffic officer.
- 5 When dealing with complex traffic movements it may be necessary for a traffic officer to give signals that combine more than one of the elements of those described above. For example, when directing turning traffic, it may be necessary for the traffic officer to cut off traffic flow from the left by holding his extended arm at 90 degrees to his body instead of parallel to his body.
- 6 A traffic officer using hand signals should be positioned within the junction in a position most visible from all approaches and as close as possible to the centre of the junction, subject to paths of the vehicles that are permitted to enter the junction at any given time.

#### 15.2.2 Point control of junctions

- 1 Traffic officers or authorised pointsmen are often used for the control of traffic at junctions during peak periods. A traffic officer or pointsman may also intervene with the operations of traffic signals.
- 2 It is possible to achieve very efficient traffic operations with point control at isolated junctions. In a network of traffic signals, this is more difficult, if not impossible to achieve.
- 3 The basic objective of point control of an isolated junction is to keep the junction as busy as possible and to eliminate all lost time. Only queues of vehicles should be allowed to discharge from one or more approaches, after which priority should revert as soon as possible to other waiting queues.
- 4 Where possible, a discharging queue should not be stopped since any overflow of vehicles would increase delay. If sufficient time is not provided for such a queue to discharge, the queue will grow indefinitely, causing excessive delay to traffic.
- 5 However, giving too long a period of right of way to one or more approaches, would result in lost efficiency every time departure flow rate drops below the maximum possible departure flow rate. The delay experienced by stopped vehicles increases while approaches from which vehicles depart are operating at low levels of efficiency.
- 6 The objective of an efficient point control strategy, therefore, is to switch right of way as soon as the queue of vehicles has departed from an approach (but only if there are vehicles waiting in other queues). This, however, is subject to limits since right of way cannot continuously be provided to one stream of traffic while other vehicles are experiencing long delays. Right of way should not be given to one stream for longer than approximately 1 minute.

### 15.3 FLAG SIGNALS SS2

- 1 FLAG SIGNALS SS2 may also be used to control the movement of traffic, and as such are regulatory signals. Such signals will generally be used at roadworks and for the control of traffic during sporting and other events. It is particularly appropriate for small and mobile works where flags may also be combined with road signs and/or construction vehicles.
- 2 According to the National Road Traffic Regulations, **"a flag signal SS2 shall conform to the requirements of the flag signals shown in Figure 15.2 and shall be:**
  - (a) **a flag signal to stop, indicating to the driver of a vehicle that he or she shall stop until the flag signal referred to in b) below is displayed; and**
  - (b) **a flag signal to proceed indicating to the driver that he or she shall proceed when the flag signal is displayed"**.
- 3 A WARNING FLAG SIGNAL may also be used to warn a road user to proceed slowly, and be alert of a hazard in or adjacent to the roadway ahead.
- 4 A good, active flagman can be as effective as any other means of drawing attention to a hazard in the roadway. The reason for this is that the flag movement makes a very effective visual target in the field of view of the driver. A good flagman will also make sure that a driver is aware of the signal.
- 5 Innovative techniques may also be employed with a warning flag signal to good effect. A flagman may, for instance, stand at a particularly important road sign and point to it with a second flag.
- 6 Flagmen should be chosen for their general alertness, good eyesight, hearing, and an adequate ability to communicate in a pleasant manner with the driving public. It must be realised, however, that the task of flagging is a boring one. Flagmen should therefore be organised into rosters and should be alternated at regular intervals.
- 7 The careful training of flagmen is essential before making them responsible for the flow of traffic. The efficiency of flag control is often dependent on their training.
- 8 Flagmen should wear conspicuous and distinctive clothing such as fluorescent-coloured helmets, bright coloured overalls together with a safety vest or jacket utilising retro-reflective and/or fluorescent panels in red, yellow, and/or white.
- 9 Flagmen should be located well in advance of the hazard to which attention is being drawn. This distance should at least provide sufficient time for vehicles to slow down before reaching the hazardous location, but not at such a distance that drivers will tend to increase speed. The flagman should stand in a very visible position.
- 10 The flagman should either stand on the shoulder adjacent to the lane of traffic they are controlling or in a barricaded lane. Under no circumstances should they stand in the traffic lane. The flagman should stand alone, and nobody should be allowed to gather around the flagman.
- 11 In many circumstances, the function of the flagman is to draw attention to other temporary road traffic signs. He or she will therefore commonly be located at the beginning of an advance sign sequence where traffic is moving at high approach speeds. Flagmen may also be used within a roadwork site to draw attention to a specific localised hazard.
- 12 FLAG warning signals SS2 should be square with a minimum side length of 450 mm. A side length of 600 mm is preferred for high-speed approaches (70 km/h or higher) or high traffic volumes. FLAGS should be made of a bright red or red-orange material attached to a staff approximately 1 m in length. The free edge, and if necessary the diagonal of the flag may be stiffened to maximise the visible area. However, such stiffening should not remove all capability of the flag to be waved. Retro-reflective and/or fluorescent materials are recommended. Flags shall be kept clean at all times.
- 13 Additional details on the use of flag signals and flagmen are given in Chapter 13 of Volume 2 of the Road Traffic Signs Manual.

### 15.4 FLASHING YELLOW WARNING SIGNALS SS3

- 1 The FLASHING YELLOW WARNING SIGNAL SS3 may be used to warn a road user of the presence of a particular hazard or traffic control device. Signal SS3 may be combined with REGULATORY or WARNING signs as illustrated in Figure 15.3, and it forms part of an emergency flashing light warning sign W346 or TW346.
- 2 The signal light shall conform in all respects to the requirements for a traffic light signal and, in South Africa, conform to the South African standard specification SANS 1459: *Traffic lights*. The exceptions are as follows:
  - (a) The light signal shall be used to display a FLASHING YELLOW DISC LIGHT SIGNAL only, and shall not be used to display a steady light signal.
  - (b) No other light signal shall be displayed at, or alongside, the flashing yellow warning signal.
  - (c) Duplicate light signals, up to a maximum of four, may be provided at one sign and these may flash alternately.
  - (d) Signal posts shall be as for road signs.
- 3 Whilst the signal should be conspicuous, it shall not obscure the sign or distract attention from it. The brightness of the signal should not cause "discomfort glare" or "disability glare", particularly at night. If necessary, provision should be made to reduce the luminous intensity of light signals automatically during the hours of darkness.

- 4 The signal may be operated 24 hours every day, or intermittently, as required. Intermittent operation may be achieved by means of a time switch, or by an external input, for example, upon the actuation of a pedestrian push button at a pedestrian crossing.
- 5 It is recommended that flashing yellow warning signals should only be used in conjunction with road signs. The installation and operation of a flashing yellow warning signal is warranted where hazardous conditions exist on the road and/or it is necessary to draw attention to a road sign and reinforce its effect. If the signal can be warranted, an appropriate road sign must similarly be warranted. The road sign will indicate to drivers the specific nature of the hazard which the flashing signal cannot do. Installations shall be permanent except at roadworks where flashing yellow warning signals may be used with any of the prescribed temporary warning signs.
- 6 Single flashing yellow warning signals can only be used with warning signs where it is necessary to draw attention to the warning sign and reinforce its effect.
- 7 Two or four flashing yellow warning signals may be used with any road sign, but the arrangement and brightness of the signal should not detract attention from the sign or cause disability glare. The signals should flash alternately (singly on in pairs) and not randomly.
- 8 Flashing signals shall operate at a frequency of between one and two flashes per second and the luminous intensity shall be zero for 30% - 50% of the period and not less than the specified minimum for 30% - 50% of the period.

## 15.5 FLARE SIGNALS SS4

- 1 The FLARE warning signal SS4 may be used to warn the road user of a temporary hazard in the roadway ahead and to indicate that they should reduce speed immediately.
- 2 Road safety flare signals SS4 are temporary devices with a high visual impact which may be used as an "immediate action" device by traffic officers attending the scene of a collision or other incident which affects the use of all or a portion of a roadway. Such flare signals should emit a red or red/orange light and moderate smoke. Flare signals permit traffic officers to deal speedily with any life threatening aspects of the incident before giving more detailed attention to traffic control.
- 3 It is recommended that two flares be used at any location. These should be placed well in advance of the incident site. As a guideline the first flare should be located a distance  $2xD$  metres in advance, where "D" is the speed limit in km/h. The second flare should be located at a similar distance in advance of the first flare.
- 4 Before setting out flare signals the following checks should be carried out:
  - (a) Does the incident involve any hazardous/inflammable materials?
  - (b) If it does, can these drain in the direction of the flares?
  - (c) Is the roadside vegetation, in combination with the wind a fire risk?
  - (d) Can the flare signal be made safe from falling over or rolling in the prevailing wind?FLARE signals shall not be held in the hand, or waved in the air.

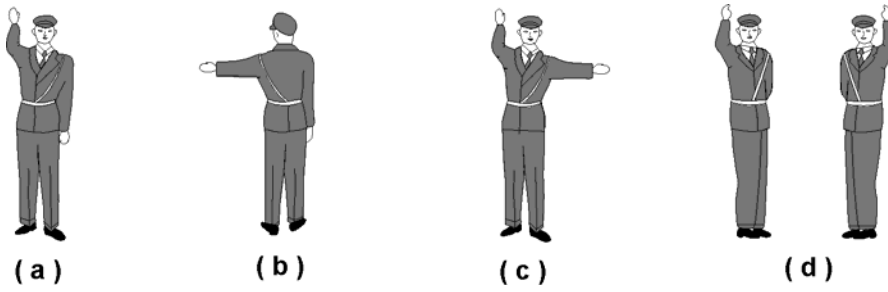

Figure 15.1: Control hand signals for use by traffic officers SS1

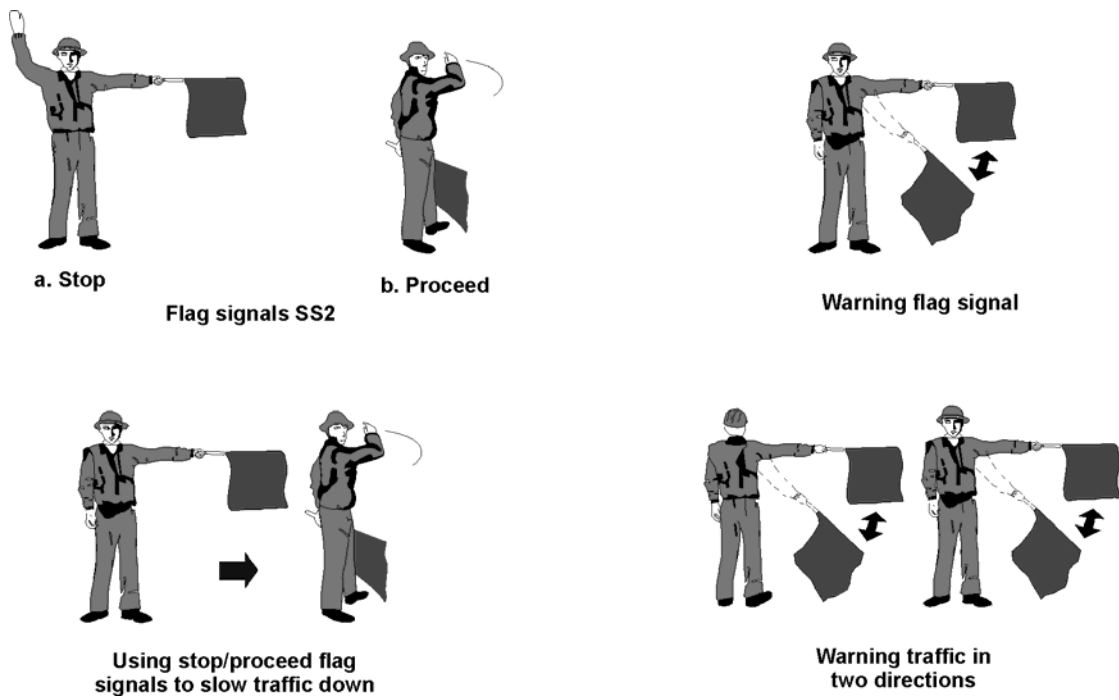

Figure 15.2: Flag signals SS2

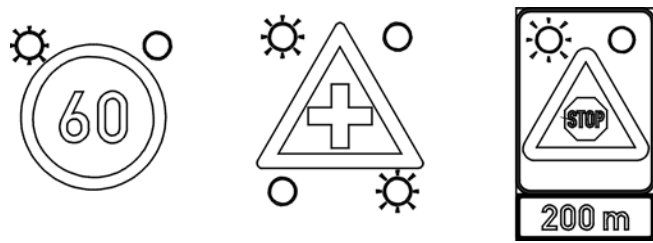

Figure 15.3: Flashing yellow warning signals SS3

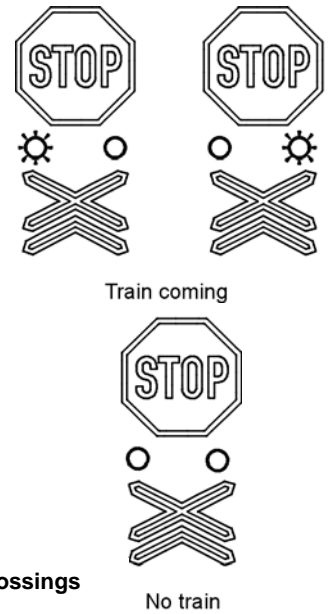

Figure 15.4: Flashing red disc light signals at railway crossings

# **SOUTH AFRICAN ROAD TRAFFIC SIGNS MANUAL**

## **VOLUME 3: TRAFFIC SIGNAL DESIGN**

**DIGITISED VERSION – May 2012**

### **PART 2 TRAFFIC SIGNAL EQUIPMENT**

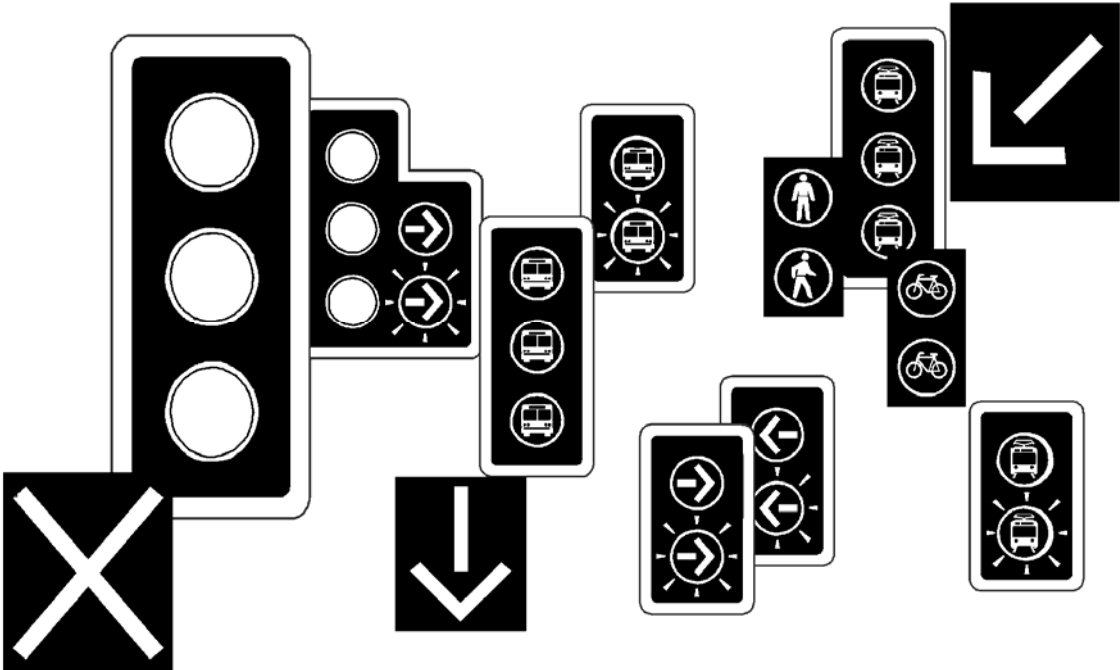





## CHAPTER 16: LIGHT SIGNALS AND POSTS

### 16.1 INTRODUCTION

- 1 The traffic light signal is the means by which a traffic signal communicates with the driver, and is therefore one of the most important components of a traffic signal installation.
- 2 The light signal is the green, yellow or red signal displayed by illuminating a signal aspect. The various components involved with ensuring the effective display of the light signal are discussed in this chapter. This includes the background screen (backboard) as well as the posts used to support the light signal.

### 16.2 SIGNAL ASPECTS

#### 16.2.1 General

- 1 The signal aspect is the unit that displays a light signal when illuminated. An example of a signal aspect is shown in Figure 16.1. It consists of various components, such as a lens, a reflector, lamp, louvres and a visor.
- 2 Traffic light signals should be manufactured and installed in a disciplined and standardised manner. The use of the South African standard specification SANS 1459: *Traffic lights* is prescribed. These specifications specify all components of the light signal, including the lamp that may be used.
- 3 According to the National Road Traffic Regulations, **“every flashing light signal shall operate at a cycle frequency of between one and two flashes per second”**. The luminous intensity shall be zero for 30% - 50% of the period and not less than the specified minimum for 30% - 50% of the period.

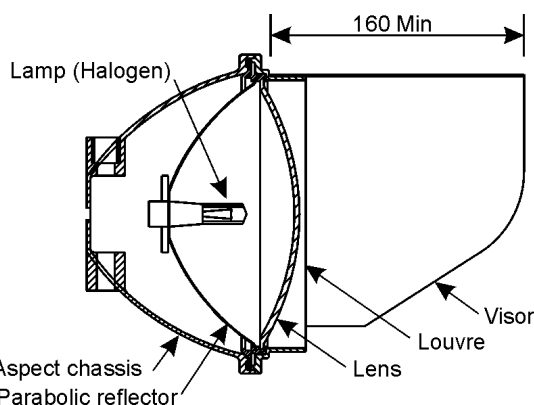

Figure 16.1: Components of a signal aspect

#### 16.2.2 Luminous intensity

- 1 The luminous intensity level of a signal aspect defines the brightness of a light. Two intensity levels may be specified, namely NORMAL or HIGH.
- 2 Normal intensity lights should always be specified for pedestrian signals. Normal or high intensity lights may be used for vehicular signals, depending upon the operating conditions.
- 3 Conditions where high intensity lights should be used, include any one or more of the following:
  - (a) Where the speed limit on a road is 70 km/h or higher.
  - (b) Where increased visibility is necessary due to a confusing background of bright lights or other traffic lights or signs.
  - (c) Where visibility is affected by a rising or setting sun in the east/west direction.
  - (d) Where drivers would not normally expect to encounter a signal, such as in rural areas or on the edges of a town or city.
- 4 High intensity traffic lights may cause "discomfort glare" or "disability glare" at night, especially in dark surroundings and in the absence of street lighting. It is recommended that, in such situations, a facility for automatically dimming signal lamps at night should be provided. Such dimming can be operated by a photo-electric cell.

#### 16.2.3 Aspect size

- 1 Two sizes of signal aspects may be used for pedestrian and vehicular signals, namely 210 mm and 300 mm nominal diameter.
- 2 The larger aspect is not often used because it does not contribute significantly to visibility as much as luminous intensity, particularly when used to display DISC light signals. It may assist to enhance recognition of a symbolic light aspect, such as the arrow signals. These arrow signals, however, are generally recognisable by their location relative to other light signals. The flashing green arrow light signal, in particular, is readily recognised because it is the only flashing green signal permitted.
- 3 Pedestrian aspects of 210 mm diameter should be adequate for normally-sighted people up to a distance of 35 m. The larger aspect may be considered for crossings wider than 35 m, but then it would be preferable to provide a staggered crossing. The larger aspect can be used at a crossing that is regularly used by people with impaired vision.

### 16.3 SIGNAL LOUVRES AND VISORS

#### 16.3.1 General

- 1 Louvres and visors are provided to modify the angular visual coverage of the light signal and/or to shield the optical system from incidental light that may cause sun-phantom effects.
- 2 Sun-phantom is the phenomenon whereby a signal aspect that is not illuminated by its lamp, emits light due to the reflection of the rays of the sun when they strike the aspect. The aspect thereby gives the appearance of being illuminated and of giving a light signal.
- 3 Sun-phantom effects can be minimised by installing visors and, where possible, aligning a signal aspect so that it does not reflect the direct rays of the sun (although this is not always possible).

#### 16.3.2 Signal louvres

- 1 Louvres are installed as either horizontal or vertical plates. Horizontal louvres can be used to minimise sun-phantom effects. Vertical louvres are used to provide additional shielding when visors are inadequate, such as at skew intersections.
- 2 The use of louvres should be restricted because of the loss of efficiency of the optical system. They should only be used when the visors alone are unable to provide the necessary cut-off.
- 3 Louvres SHALL not be used in association with symbolic displays such as arrows, pedestrian and pedal cyclist signals.

#### 16.3.3 Signal visors

- 1 A suitably designed visor SHALL be fitted to each vehicular signal aspect. Pedestrian and pedal cyclist signal aspects may also be fitted with visors. The visor shall have a length of at least 160 mm at the top (see Figures 16.1 and 16.2).
- 2 The visor should not prevent required visibility standards from being achieved. Cut-away visors may be used to increase visibility from one side, as shown in Figure 16.3.
- 3 Visor compliance with SANS 1459: *Traffic lights* is prescribed. Visors shall have a matt black finish inside and outside.

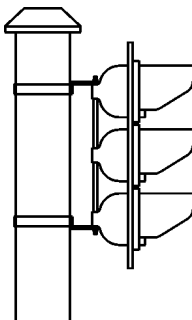

Figure 16.2: Signal head with standard visors

### 16.4 SIGNAL HEADS AND BACKGROUND SCREENS

- 1 Signal heads are fixed to posts by means of brackets as shown in Figures 16.2 and 16.3. The brackets should facilitate adjustment of the alignment of a signal in both the vertical and horizontal planes. The brackets should operate with self-locking screw clamps, and crimping of straps should not be allowed.
- 2 According to the National Road Traffic Regulations "**a background screen SHALL be provided for each vehicular signal face**" while "**background screens may be provided** (but are not necessarily recommended) **for pedestrian and pedal cyclist signal faces**". "**Background screens shall comply with standard specifications SANS 1459: Traffic lights**".
- 3 Background screens (or backboards) are normally 500 mm wide with a white border of 50 mm wide. According to the National Road Traffic Regulations, "**where it is necessary to increase the conspicuity of a traffic signal, the border of the white background screen provided for a signal face may be white retro-reflective**".

### 16.5 POSTS FOR SUPPORTING LIGHT SIGNALS

- 1 Traffic signal posts should have a diameter of at least 100 mm. Signal posts should preferably be protected against rust by galvanising, and be provided with a removable weatherproof cap that will facilitate wiring.
- 2 Signal posts can be mounted directly in the ground and a concrete foundation is not required. From a traffic safety viewpoint, it is safer not to provide a concrete foundation. Where heavy winds occur, a base plate can be provided for additional stability. Standard posts should be installed at least 900 mm deep, and extended posts at least 1200 mm deep.
- 3 Overhead cantilever and gantry supports will require concrete foundations. These foundations should be designed according to appropriate engineering principles, taking all superimposed loads, such as wind loads, into account. The size of these foundations should, however, be kept to a minimum subject to stability requirements.

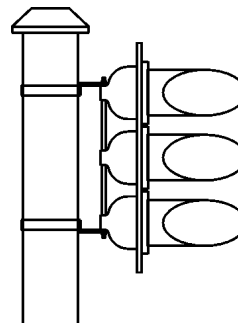

Figure 16.3: Signal head with cut-away visors

- 4 According to the National Road Traffic Regulations, ***“in the case of a road signal the standard, post or cantilever shall be golden yellow, portions of which may be retro-reflective”***. However, ***“this provision shall not be applicable to an overhead traffic signal mounted on a GANTRY”***.
- 5 Retro-reflective strips may be provided on traffic signal posts to increase the conspicuity of the posts at night, particularly when there is a loss in the electricity supply. Three horizontal yellow retro-reflective strips can be fitted on ALL yellow signal posts, as shown in Figure 16.4. The width of the strips may be between 120 and 150 mm. The width of the openings should be about the same as that of the strips. The bottom strip should not be installed lower than 1,2 m and the top strip not higher than 2,1 m above the ground level.

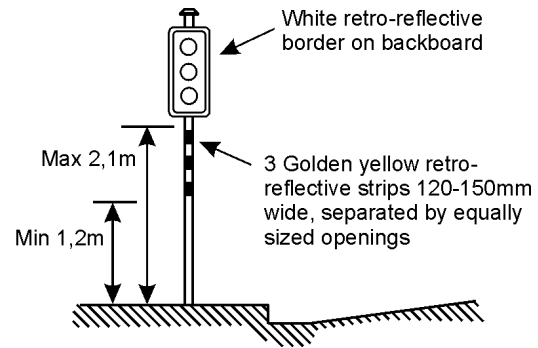

Figure 16.4: Improving conspicuity of signals



## CHAPTER 17: FACILITIES FOR DISABLED USERS

### 17.1 INTRODUCTION

- 1 Facilities can be provided at signalised junctions and pedestrian crossings for pedestrians with physical disabilities (no such facilities are required by disabled drivers). The following groups of disabled persons can be accommodated at signals:
  - (a) those confined to wheelchairs; and
  - (b) those with visual impairments.
- 2 With regard to persons confined to wheel-chairs, it is particularly important that recessed ramps should be provided in the corner kerb, and that push buttons can be reached (a mounting height of 1,1 m would be acceptable). It may also be necessary to provide a longer flashing red man clearance interval.
- 3 The remainder of the chapter will be devoted to the needs of pedestrians with visual impairments.

### 17.2 THE PROBLEMS OF PEDESTRIANS WITH VISUAL IMPAIRMENTS

- 1 Pedestrians with visual impairments are confronted by a host of problems when attempting to cross a street at a signalised junction or pedestrian mid-block crossing. These can be summarised as:
  - (a) Knowing when to begin crossing.
  - (b) Crossing in the correct direction.
  - (c) Using push buttons.
- 2 In the absence of audible signals, visually impaired pedestrians rely on hearing the surge of traffic at signalised junctions moving in a parallel direction as a marker for the start of crossing. A problem with a scramble or exclusive pedestrian signal phase is that a surge does not occur and, short of being told by a bystander, the visually impaired pedestrian would find it difficult to know when to begin crossing.
- 3 Parallel traffic provides an acoustic guideline to help pedestrians with visual impairments to cross the street without veering to one side or the other. Intermittent traffic does not offer the required guidance. Such pedestrians may also find it difficult to cross the road if the crosswalk is far removed from the parallel traffic flow.
- 4 The geometry of the junction can also be a source of confusion to pedestrians with visual impairments. Have they successfully crossed the street or have they merely found the median island? It may also be difficult to differentiate between medians and islands provided at slipways.
- 5 Push buttons present two problems, namely locating the push button and then establishing the direction of movement to which it applies. Visually impaired pedestrians memorise the position of push buttons and the direction to which they apply as they learn a particular route. Push buttons should therefore be located as consistently as possible relative to the position of the crosswalk. Preferred locations for push buttons are shown in Chapter 4 of this manual (Volume 3).

### 17.3 FACILITIES TO ASSIST VISUALLY IMPAIRED PEDESTRIANS

#### 17.3.1 General

- 1 The provision of facilities for pedestrians with visual impairments is not a simple matter, and no satisfactory solution has as yet been developed. The following are a number of facilities that have been provided and tested:
  - (a) Audible signals.
  - (b) Vibrotactile signals.
- 2 In addition to the above facilities, a number of special devices have been developed that require highly sophisticated equipment and technology to communicate with or identify visually impaired pedestrians. Many of these are still in an experimental phase and are not available in commercial systems. These systems are not discussed in this manual.

#### 17.3.2 Audible signals

- 1 Audible signals may be used to indicate to visually impaired pedestrians that the green man light signal is provided (no such signal is required for the flashing red man clearance interval). The signal is sounded for a short duration at the start of the green man light signal.
- 2 Although audible signals may, at first glance, appear to be the best available solution, they are not always as useful as they could be. There are a number of problems. The first of these is the problem of noise pollution. For the visually impaired pedestrian, there is also the problem of identifying which crosswalk has the walk signal.
- 3 The problem of noise pollution can to some extent be addressed by carefully adjusting the volume of the audible signal. Provision can also be made for automatically adjusting the volume of the signal in response to ambient sound levels.
- 4 The problem of identifying which crosswalk has the walk signal can be addressed by using different tones or signals. Standardised tones may be adopted at different junctions and crossings in an area to indicate crosswalk directions. Verbal messages may also be given indicating the name of the street that can be crossed.
- 5 Where pedestrians experience problems in locating push buttons, audible locator signals may be considered to assist pedestrians in finding the push buttons. A special tone is required to allow the pedestrian to locate the push button. These signals, however, make the problem of noise pollution even worse since they have to be in continuous operation.

**17.3.3 Vibrotactile signals**

- 1 Vibrotactile devices communicate information to pedestrians through a vibrating surface by touch. These devices address the problem of noise pollution associated with audible signals, but only if they are designed in such a way that the vibrations are not audible.
- 2 Vibrotactile signals can be provided in the form of a vibrator attached to a signal post. The vibrator should be continuously vibrating to indicate to the pedestrian that it is in operation and not out of order. Two levels of vibration are used, one to indicate that the green pedestrian signal is being displayed, and the second to indicate the red or flashing red light signal.
- 3 The frequency and amplitude of vibration would have to be carefully selected to ensure that the pedestrian can differentiate between the two signals. It is also important that the pedestrian does not confuse the vibration with an electrical shock.
- 4 The vibrators should be installed on the same posts as the normal pedestrian push buttons. The position of the post can be used to indicate the direction to which the vibrotactile signal applies. Where this is not adequate, a raised arrow may be mounted on the vibrator indicating the direction of the signal.

## CHAPTER 18: TRAFFIC SIGNAL CONTROLLERS

### 18.1 INTRODUCTION

- 1 Traffic signals are controlled and switched on and off by electrical or electronic equipment called "traffic signal controllers" (or simply "controllers"). It is normal practice to have a controller for each signalised junction, although one controller may sometimes be used to control signals at two closely spaced junctions.
- 2 The controller is essential for the proper and safe operation of a traffic signal. In addition to the basic function of switching signals on and off according to timing plans, it must also be able to prevent green signals being displayed to conflicting traffic movements. When required, the controller must also be able to interface with communication facilities required for co-ordinated control.
- 3 Traffic signal controllers in South Africa shall comply in all respects with the requirements contained in the South African standard specification SANS 1547: *Traffic signal controllers*.

### 18.2 CONTROLLER TYPES

- 1 Various technologies are used in traffic signal controllers. The SANS 1547 specifications classify the technologies as electromechanical, solid state and microprocessor. The controllers are classified as Class A, B and C controllers.
- 2 Class A electromechanical controllers were the earliest type of controller and use an electrical motor to drive a revolving camshaft that opens and closes electrical contacts. The sequence of signal stages is predetermined and fixed by the sequence of the cam breakouts on the camshaft. These controllers are not generally able to perform the same range of functions as modern electronic controllers. Despite this limitation, however, electromechanical controllers have retained their popularity, mainly because of their robustness.
- 3 Class B solid state electronic controllers utilise relatively basic transistorised electronic circuitry, although electromechanical relays are used for lamp switching.
- 4 Class C microprocessor controllers utilise integrated circuits (or microchips) and solid state lamp switching for the control of signals. Some controllers require the "burning" in of programs using various forms of read only memory (ROM). Other controllers utilise general-purpose, industrial type programmable processors that allow software to be readily modified.

### 18.3 CONTROLLER FUNCTIONS

- 1 Controllers must be able to serve a variety of functions, not only aimed at improving traffic flow and road safety, but also at reducing the effort required to maintain the traffic signal. Some functions are essential for safe operations, while other functions are provided to improve operational efficiency.
- 2 Some of the functions of a controller are shown schematically in Figure 18.1. All traffic signal controllers must be capable of providing at least the following minimum subset of functions:
  - (a) **Manual interface** which allows for the timing of the controller and setting of signal phases. A manual control facility can also be provided.
  - (b) **Signal timing and phasing** for the control of signal phases and stage intervals.
  - (c) **Signal switching** which provides for switching each signal light (or groups of signal lights) on or off.
  - (d) **Conflict monitoring** to prevent a controller giving right of way to conflicting signal groups that could result in traffic accidents.
- 3 Other additional functions that can optionally be provided by a controller are also shown in Figure 18.1. These are the following:
  - (a) **Fault monitoring** for the detection of controller and other faults (particularly signal lamps).
  - (b) **Detector units** used in combinations with vehicle detection devices.
  - (c) **Communication** functions allowing for communications with other controllers or a central control system.
  - (d) **Signal synchronisation** used to synchronise traffic signal controllers in a co-ordinate network of traffic signals.
- 4 A very important requirement of controllers is that they should not lose traffic signal settings in case of power loss or failure. In electronic controllers, this can be achieved by providing non-erasable memory or a backup battery.

### 18.4 CONFLICT MONITORING

- 1 Conflict monitoring is an essential function of the controller and is required to prevent a controller giving right of way to conflicting signal groups that could lead to traffic accidents.
- 2 In electronic controllers, conflict monitoring occurs on the output side of the controller where the power output to signals is monitored. In electromechanical controllers conflict monitoring is provided by locking cams on a single shaft and interlocking of shafts.
- 3 If it is found that conflicting signals are receiving power at the same time, the signal is switched to flashing mode.

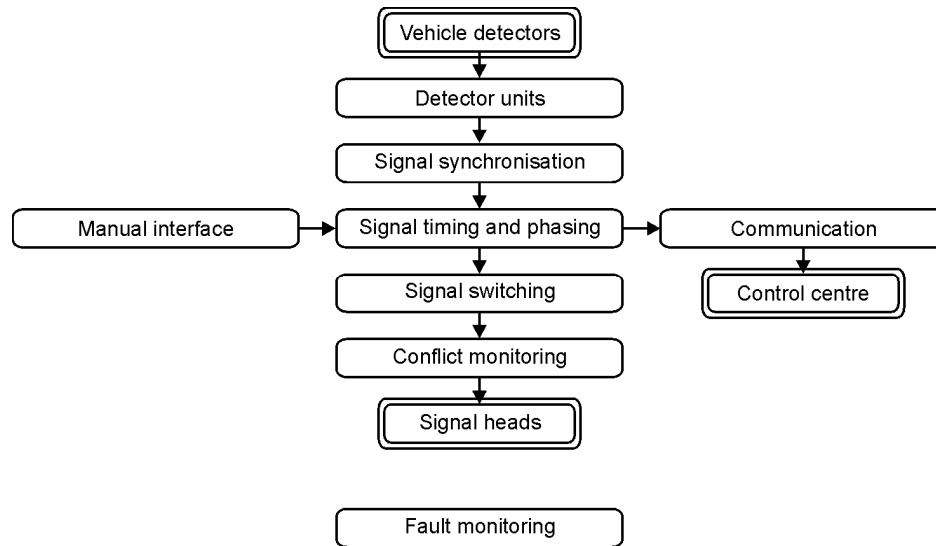

Figure 18.1: Schematic presentation of controller functions

### 18.5 FAULT MONITORING

- 1 Fault monitoring is an important function that can be provided by some controllers and is used for the detection of various faults that may occur in traffic control equipment, including the signal lamps.
- 2 Lamp fault monitoring is used to detect the failure of signal lamps. In its most basic form, it may be used to detect whether all red lamps on one signal group have failed. Should this occur, one or more of the actions listed below are initiated. Where lamp fault monitoring is a requirement, it is recommended that separate signal groups be allocated to each separate approach. This will allow the controller to detect whether all red lamps on one approach have failed.
- 3 On detection of a fault, the controller can initiate one or more of the following actions:
  - (a) In the event of a fault compromising the safety of the junction, switch to flashing control.
  - (b) In the event of other faults, activate a warning light or similar device at the controller.
  - (c) Report the fault to the central control computer if under central control.

### 18.6 SIGNAL SYNCHRONISATION

- 1 Accurate synchronisation of signal controllers is critical to the establishment and maintenance of traffic signal co-ordination. If the time in any of the controllers drifts with respect to other controllers, the signal timings will fall out of step. This could have a serious impact on progression along a road or street.
- 2 Although accurate timing equipment is available, it is difficult, if not impossible, to achieve perfect synchronisation of controllers. This means that timing units will have to be reset at regular intervals, either manually or by linking with a central control unit. The need for resetting controllers can be reduced by using more accurate timing units (which would reduce communication costs).
- 3 Different techniques are available to improve the accuracy of the timing unit. These include the following:
  - (a) Electrical mains frequency.
  - (b) Electromechanical motors with synchronous motors.
  - (c) Electronic crystal clocks.
  - (d) Global positioning system clocks.



- 4 The **electric mains frequency** of the electrical power supply can be used to improve timing accuracy. Timings may still drift during the day, but synchronisation is still maintained because all the controllers reference the same time source (except where power is taken from different electrical supplies). Synchronisation can, however, not be maintained where there are frequent power interruptions or where the quality of the power is poor.
- 5 **Electromechanical controllers with synchronous motors** can be used effectively under certain circumstances, again provided that all the controllers receive power from the same source. This, however, is not a very accurate method, and periodic resetting of the controllers will be required to maintain co-ordination.
- 6 **Electronic crystal clocks** can be utilised to provide a common time base between different traffic signals. This method, however, is still not sufficiently accurate to provide the required accuracy in signal timings over a long period without the clock being corrected periodically.
- 7 **Global positioning system (GPS)** receivers can be used in controllers to access the time component of the data stream transmitted from one or more GPS satellites on a continuous basis. This provides an exceptionally accurate time signal with the advantage that it does not require periodical resetting of timing units.

## 18.7 CONTROLLER CABINETS

- 1 The controller is housed in a cabinet that should be robust, corrosion resistant and generally of high quality.
- 2 Particular attention should be given to the quality of the doors. Seals and gaskets should be provided that will prevent the ingress of moisture and insects. Doors must be provided with strong locks to prevent unauthorised access. The door should also be fitted with a bracket to allow retaining the door in the open position.
- 3 Provision should be made inside the cabinet for storage of a controller log and other documents.
- 4 The controller should preferably be located at a junction or crossing in a position where:
  - (a) It can be readily accessed for maintenance purposes.
  - (b) The likelihood of accident damage is a minimum.
  - (c) Where the cabinet door is unobstructed and can be opened to its fullest extent.
  - (d) Where most of the traffic signal faces can be readily observed from.



## CHAPTER 19: CENTRAL CONTROL SYSTEMS

### 19.1 INTRODUCTION

- 1 A central traffic control system co-ordinates and controls the operation of a network of signal junctions and crossings. The objective of such a system in the first place is to improve the efficiency of traffic flow, but it also has a secondary objective of managing the signalised system itself.
- 2 Central control systems utilise a central computer (or master controller) for controlling the signal network. Such a system consists of two main components:
  - (a) An instation located at a control centre and/or a control room. The instation equipment comprises traffic computers, computer peripherals, software and instation data transmission equipment.
  - (b) Outstations located at various local controllers under the control of the central system. Outstation equipment comprises outstation data transmission equipment connected to, or integral within, the local traffic signal controller, traffic detectors and other items of street equipment such as variable message signs.
- 3 Central control systems can vary in complexity from the relatively simple systems, to the most complex of systems. In its simplest form, the central computer may purely monitor the performance of on-street equipment. The more complex systems have facilities to update signal plans at a local controller, possibly in response to traffic demand.

### 19.2 CONTROL CENTRES AND ROOMS

- 1 A control centre is provided to accommodate the central computer system as well as control equipment for data communications. It also provides for manual operations and intervention of the control system.
- 2 The control room is typically equipped with control consoles and a dynamic wall map. This map can either be physically constructed, or can be a computer-projected image. The map takes the form of a simplified map of the street network under control, showing the location of signalised junctions and crossings. The operational state of each signal is indicated on the map.
- 3 A control room can also be equipped with a closed circuit television system (CCTV) which is used for manual monitoring of traffic. The operator may implement signal plans based on events observed on the television monitors.

### 19.3 CENTRAL CONTROL COMPUTERS

#### 19.3.1 Computers and equipment

- 1 Depending on the number of signals controlled, one or more instation computers may be required. The configuration will depend on:
  - (a) The number of intersections restricted by the software or equipment (dependent on the supplier).
  - (b) The maximum number of signal controllers that should be controlled by one computer. A guideline is about 200 signal controllers.
  - (c) The control strategy followed.
- 2 It may be desirable to use a computer system whereby one computer acts as a Traffic Management Computer and one or more Traffic Control Computers provide the signal control functions. Alternatively, different computers may provide the same function, which has the advantage that in the event of a computer failure a standby facility exists.
- 3 Other peripheral computer equipment would typically include:
  - (a) Control console for accessing the computers.
  - (b) Log printer(s).
  - (c) Storage device for regular data backup.
  - (d) Additional hard disk drive for data storage e.g. traffic counts, fault logs etc.
  - (e) Dial-in modem enabling remote access to the system. For improved security a dial-in/dial-back facility can be specified whereby the authorised dial-back numbers are specified.
  - (f) A "roving terminal" which allows communication with the control system by on-street personnel via a cellular telephone link (if such a facility is available).
  - (g) Wall display map or alternatively an overhead projection device.
- 4 The central control computer should be capable of running unattended and be fully operational for 24 hours per day, throughout the year. The number of system parameters and commands required to take the system off- and online should be a minimum.
- 5 The control computer should be relatively fast and be able to perform all tasks as and when required. The system should be capable of operating with all junctions on minimum cycle times with no obvious or apparent degradation in performance or speed of response.
- 6 Providers of central control systems normally supply all of the system software required for the maintenance and operation of such systems. Some systems, however, may require the use of additional software developed by a third party. Traffic adaptive and responsive systems, in particular, may require such third-party software at additional cost.

### 19.3.2 User interface

- 1 The central control system should preferably be operated in a multi-tasking operating system, if possible with a graphical user interface. Significant benefits can be achieved if the system can also handle graphics and diagrams.
- 2 The system terminal should typically be able to display and dynamically update information such as the following for a selected signal controller or other items of street equipment:
  - (a) Current date, day of the week, and time.
  - (b) Equipment identification number, equipment type and other references.
  - (c) The current mode of control.
  - (d) The current plan number, cycle length, stages (including omitted stages), offset times, minimum and maximum green and intergreen times as well as times of scheduled plan changes.
  - (e) Control and reply messages dynamically updated in real time.
  - (f) Details of current faults as well as fault summaries per sub-region, region and total.
- 3 Efficiency can be improved if systems have the facility to display progression diagrams. It should be possible to display such diagrams in either "live update" mode with the diagram driven by stage green reply data from the controllers, or "predictive" mode, whereby a prediction of the effect of a selected set of plan timings is displayed without those timings being implemented.

### 19.3.3 System log

- 1 The central control system should have the capacity to store all system log data output for at least five years. A backup of such data should also be kept.
- 2 The disc system log would normally contain the following information:
  - (a) All messages output by the system.
  - (b) All implemented operator commands which affect the system.
  - (c) All operator comments.
  - (d) All generated fault messages.
  - (e) All operator recorded faults.
- 3 All messages should be dated and time stamped, while operator commands and comments should include the identity of the operator initiating the command or the comment.
- 4 The system should provide a command log that will allow the system to be restarted after a computer fault, system restart or reboot, or a power failure. The purpose of the command log is to automatically return all instation and outstation equipment to the same method of control and operational state prior to the restart.

### 19.4 OUTSTATION CONTROL

- 1 Outstations are controlled by the central control system by means of a communication system in which a control message is transmitted to each outstation. Outstations should be able to respond to and implement the commands.
- 2 The most basic facility that can be provided is that of remote monitoring of the operation of outstations with the purpose of ensuring the correct functioning of on-street equipment. *Remote Monitoring Systems (RMS)* should at least provide for the following facilities:
  - (a) Fault monitoring of outstations by requesting and receiving data on faults detected at local controllers (such as signal lamps and transmission errors).
  - (b) Synchronisation of timing equipment at local controllers.
- 3 In addition to the above facilities, it is preferable that provision should also be made to at least download signal plans to local controllers and to interrogate the local controllers on signal plans currently in operation.
- 4 In more advanced adaptive and traffic responsive control systems, outstations should also be able to return traffic data collected at vehicle detectors. Such data may include the following:
  - (a) An indication that there is a demand for a particular stage or the presence of a queue at a queue detector.
  - (b) Data collected at a traffic counting detector.
  - (c) The presence of an emergency and other vehicle priority signals.
- 5 Some advance systems also have additional facilities for the control of variable message signs from the central system. Such variable message signs can be used in traffic management systems such as parking area control.

### 19.5 COMMUNICATIONS

- 1 Data transmission between in- and outstations can be achieved by various means. The most common method is by means of leased Public Switched Telephone Network (PSTN) lines (although some authorities do have private data transmission networks). It is also possible to utilise the GSM (Global System for Mobile Communication) network for this purpose.
- 2 Each outstation utilises a modem to communicate with the central control system. Each controller effectively has its own allocated number (similar to a telephone number). The cost of providing such communication could therefore be high and is an important factor in the provision of a central control system.
- 3 Traffic responsive systems may require a permanent communication link to all outstations. The cost of such communication could be prohibitively high, requiring thorough consideration when such systems are considered for implementation.

- 4 Fixed time traffic control systems do not require transmission of large amounts of data. Such systems therefore have the advantage that a permanent communication link is not required, thus avoiding potentially high communication costs. Dial-up facilities are used to institute communications only when (and for as long as) required.
- 5 All equipment connected to the PSTN or GSM network must be approved by the operator of the network. It is important that written confirmation of such approval is obtained.
- 6 A problem that is often experienced is that data transmission protocols are in many instances proprietary, prohibiting or complicating the connection between different makes of equipment. Some protocols also carry copyrights and care must be taken to ensure that the copyrights are not infringed. In order to address the problem of different data transmission protocols, it is necessary to prescribe standardised protocols. At the time of writing this manual, some countries have started developing such standards, but no such standards were available for use in South Africa.

### 19.6 SIGNAL TIMING PLANS

- 1 The basic function of the central control system is to either implement signal timing plans, or to adjust a current timing plan.
- 2 The system should provide for the following types of plans (given from highest to lowest priority):
  - (a) Temporary plans
    - (i) Emergency signal plans (highest priority).
    - (ii) Fixed time plan imposed by manual request from a computer console.
  - (b) Permanent plans
    - (i) Traffic adaptive or responsive plans updated based on collected traffic data.
    - (ii) Fixed time plans selected according to a timetable.
- 3 Requests for a plan change should be served in order of priority. When a request for a plan is received, it will only be serviced if the current plan was requested from a source of lower priority. When multiple requests occur from the same source level, the latest request will be served.
- 4 To prevent a temporary plan from being implemented over a too long period, provision should be made for the system to make an alarm after some time. One method is to give an alarm at the next plan change time.
- 5 A temporary plan can be implemented by specifying user-defined start and termination times. Provision should, however, be made to cancel such plans prior to, or during these times. It must be possible to cancel a temporary plan at any time by manual intervention.
- 6 The introduction, implementation and cancellation of all plans should be recorded in the system log and a suitable message output to the logging printer.

### 19.7 EMERGENCY SIGNAL PLANS

- 1 The provision of emergency plans is one of the important benefits of a centrally controlled system. Such plans are provided as an aid to emergency vehicles. The signal timings required to assist such vehicles are commonly referred to as "green waves" and do not form part of the signal plans.
- 2 Green wave plans can be developed as standard signal plans, except that co-ordination would normally only be provided in one direction. A greater proportion of available green time would also be provided on the emergency route. Where necessary, turning phases would also be provided.
- 3 Provision should be made for a variety of green wave plans, between various origins and destinations.
- 4 Emergency plans should be implemented for a predetermined period of between 5 to 10 minutes, although provision can be made to manually extend this period.
- 5 When an emergency green wave plan has timed out, the system should revert to the signal plan that would have been running if the green wave had not been introduced. The time at which a green wave plan is introduced and removed as well as the green wave plan number should be output on the log printer in the control centre.



## CHAPTER 20: DETECTORS

### 20.1 INTRODUCTION

- 1 Detectors are used extensively at traffic signals to detect the presence of vehicles or pedestrians with the purpose of either adjusting signal timings or providing signal phases.
- 2 A traffic detector will generally comprise:
  - (a) A detection device, e.g. an inductive loop in the roadway.
  - (b) An electronic detector unit to serve the input provided by the detection device.
  - (c) A feeder cable connecting (a) and (b).
- 3 The detector unit is usually located in the controller cabinet and the unit interfaces electrically with the controller to provide the inputs required by the controller.

### 20.2 PEDESTRIAN PUSH BUTTONS

- 1 Pedestrian push buttons can be provided to call pedestrian phases. They are strictly speaking not detectors, as they respond only to action on the part of the pedestrian in pushing the button.
- 2 The push button unit itself must be intrinsically safe electrically and should only be used to complete a low voltage electrical circuit. The push button should be resistant against vandalism, and the button plunger should be designed to minimise the risk of jamming by foreign objects, moisture or corrosion.
- 3 The push button can incorporate a mechanism for providing tactile and audible "feedback" to visually impaired pedestrians (see Chapter 17 of this manual).
- 4 Push button units should be coloured yellow and provided with a black walking-man symbol.

### 20.3 VEHICLE DETECTORS

- 1 A wide range of vehicle detecting devices has been developed for use at traffic signals. These include the following:
  - (a) Ultrasonic detectors, which depend upon the reflection of sound waves from the vehicle.
  - (b) Infrared detectors, which depend upon the reflection of infrared light from the vehicle.
  - (c) Microwave detectors, which depend upon the reflection of very high frequency electromagnetic waves from a vehicle.
  - (d) Magnetometers, which depend upon the change in a magnetic field produced by the metal of a vehicle. These detectors are installed below the road surface.
  - (e) Inductive loop detectors, which depend upon the change in an inductive field produced by the metal of a vehicle.
- 2 The inductive loop detector is currently the most widely used method for the detection of vehicles in modern traffic control systems.

### 20.4 DETECTOR OPERATION

- 1 Modern traffic detectors can provide a variety of functions and can be operated in various modes, irrespective of the means used for the detection of traffic.
- 2 There are two fundamental modes in which detectors can operate:
  - (a) Passage (Pulse) detection - used to indicate that a vehicle has crossed a detector. No indication is given of the time the vehicle has spent while crossing the detector and the pulse is of very short duration. The signal received from the detector is therefore basically a binary "yes" or "no" code. Any extension of green commences when a vehicle reaches the detector.
  - (b) Presence detection - used to indicate that a vehicle is present on a detector. The vehicle is detected for the duration of time it spends on the detector. Any extension of green commences after the vehicle has departed from the detector.
- 3 The majority of detection systems operate in presence mode rather than passage mode. Vehicle-actuated systems in particular require the presence mode. A call is registered, and green is extended, while the presence of a vehicle is detected in such presence mode. Extension detectors will extend a green signal for a short time period when the presence of a vehicle is no longer detected.
- 4 Detectors may also be provided with either latching (locking) or non-latching (non-locking) detector memory circuits. A non-latching detector permits a waiting call to be dropped as soon as a vehicle leaves the detection area. A latching detector, however, will hold the call until it has been satisfied by the provision of green, even if the vehicle leaves the detection area.
- 5 The latching and non-latching circuits can be used for purposes such as improving the capabilities of stop line calling detectors. The locking circuit can, for instance, be used to prevent dropping of calls by vehicles that cross and stop beyond the stop line call detector. On the other hand, this facility will place demands for vehicles that clear the junction, resulting in unnecessary false calls for a green signal. It may therefore be beneficial to address this problem by providing a longer stop line detector and locating the detector in such a position that it will cover the majority of positions where vehicles will stop.
- 6 In addition to the above functions, most modern vehicle detectors are able to ignore the continued presence of a vehicle beyond a predetermined interval. This is to avoid (illegally) parked vehicles continually calling phases that are not legitimately required.

## 20.5 INDUCTIVE LOOP DETECTORS

### 20.5.1 General

- 1 Inductive loop detectors are the most widely used method of detecting vehicles, mainly as a result of their relatively low installation cost. However, when loop detectors are not properly installed and maintained, they could be prone to high rates of failure.
- 2 The inductive loop consists of one or more turns of wire placed in a slot cut into the street surface. The loop works on the principle that an electromagnetic field is generated by an electrical current passing through the loop. Any ferrous metal object passing through the field will disturb the field, and this disturbance can be sensed by the electronic detection unit.

### 20.5.2 Loop shapes and sizes

- 1 Inductive loops have been used in a variety of shapes and sizes. Preference is normally given to small size loops rather than large loops due to improved sensitivity and the lower cost of maintaining smaller loops. Often a number of small loops will be installed rather than one large loop.
- 2 Most loops are in the shape of a rectangle, diamond or parallelogram, as shown in Figure 20.1. The rectangular corners of the different shapes result in "hot spots" where the electromagnetic fields overlap, which are very effective in detecting vehicles. The efficiency of the loop can also be improved by orientating the loop 45 degrees to the kerb, as with the diamond and parallelogram shapes.
- 3 The increased efficiency of the diamond and parallelogram shaped loops is more important at higher speeds. These loops are therefore recommended when it is necessary to detect vehicles travelling at speed.
- 4 The rectangular shaped loop is recommended for the detection of stopped vehicles. The diamond and parallelogram shapes may be more effective in terms of sensitivity, but some areas of the roadway will not be covered by these loops. It is thus possible, for example, that stopped motorcycles will not be detected. The greater efficiency of these loops is also not really required when vehicles are stopped. The most effective shape for the detection of stopped vehicles is therefore the rectangular form.
- 5 A skewed stop line detector is shown in the right-most lane in Figure 20.1. Such detectors are required to prevent false calls being placed by right-turn vehicles from the crossing street encroaching on the wrong side of the road (but only where median islands are not provided).
- 6 In order to reduce false calls being placed by vehicles straddling two lanes, the edge of a loop should not be closer than 0,6 m from the lane line. Such spacing will also reduce the incidence of cross-talk between two adjacent loops.

### 20.5.3 Detector loop and unit requirements

- 1 The operations of loop detectors can be affected by a variety of factors, such as the ambient conditions. Loop detectors should therefore be self-tuning, allowing them to adjust to such conditions, and even to the presence of a parked vehicle within the detection area.
- 2 Particular care must be taken in providing protection against lightning surges. Detector loop input terminals should be electrically isolated.
- 3 A variety of loop wires are used, some more costly than others. The wire should be of a high quality and tough and be resistant to abrasion, heat and moisture. Even when wires have been manufactured according to specifications, it is good practice to pre-test the wire isolation by submerging the wire in water and testing the wire for electrical leaks (a few bends should be made in the wire before it is tested). The wire isolation should also be tested for resistance to heat that may be generated by the slot sealant.
- 4 The number of turns of wire should be calculated according to the recommendations of the manufacturer of the detection unit. The number of turns depend on the size of the loop and the type of vehicles to be detected.
- 5 The loop wire is installed in a slot, cut into the road surface as shown in Figure 20.2. The slot is cut sufficiently deep to accommodate the wire, filling material and the slot sealant. The wire should lay on a bed of suitable material (e.g. silicon sand) to prevent possible damage from an uneven surface. The wire should also be covered by some suitable material (such as silicon sand or a neoprene cord) to reduce the possibility of damage due to heat generated by the slot sealant while curing. Some sealant materials may also induce unwanted stresses in the loop wire after it has cured.
- 6 The slot sealant should be of good quality. It must be flexible to allow for possible movement in and thermal expansion of the pavement, but at the same time be tough enough to withstand vehicle tyre abrasion and the possible penetration of debris which could damage the loop wire. It must also be able to withstand the corrosive effects of road salts, fuel, and other fluids found on road surfaces. The sealant must also be able to adhere properly to both concrete and asphalt road surfaces, preferably without a primer.
- 7 In order to prevent breakage or cracking of the insulation, the loop wire should not be bent to form sharp corners, or even right angles. All corners of the loops should be cut across to reduce the angle of bending, as shown in Figure 20.1.



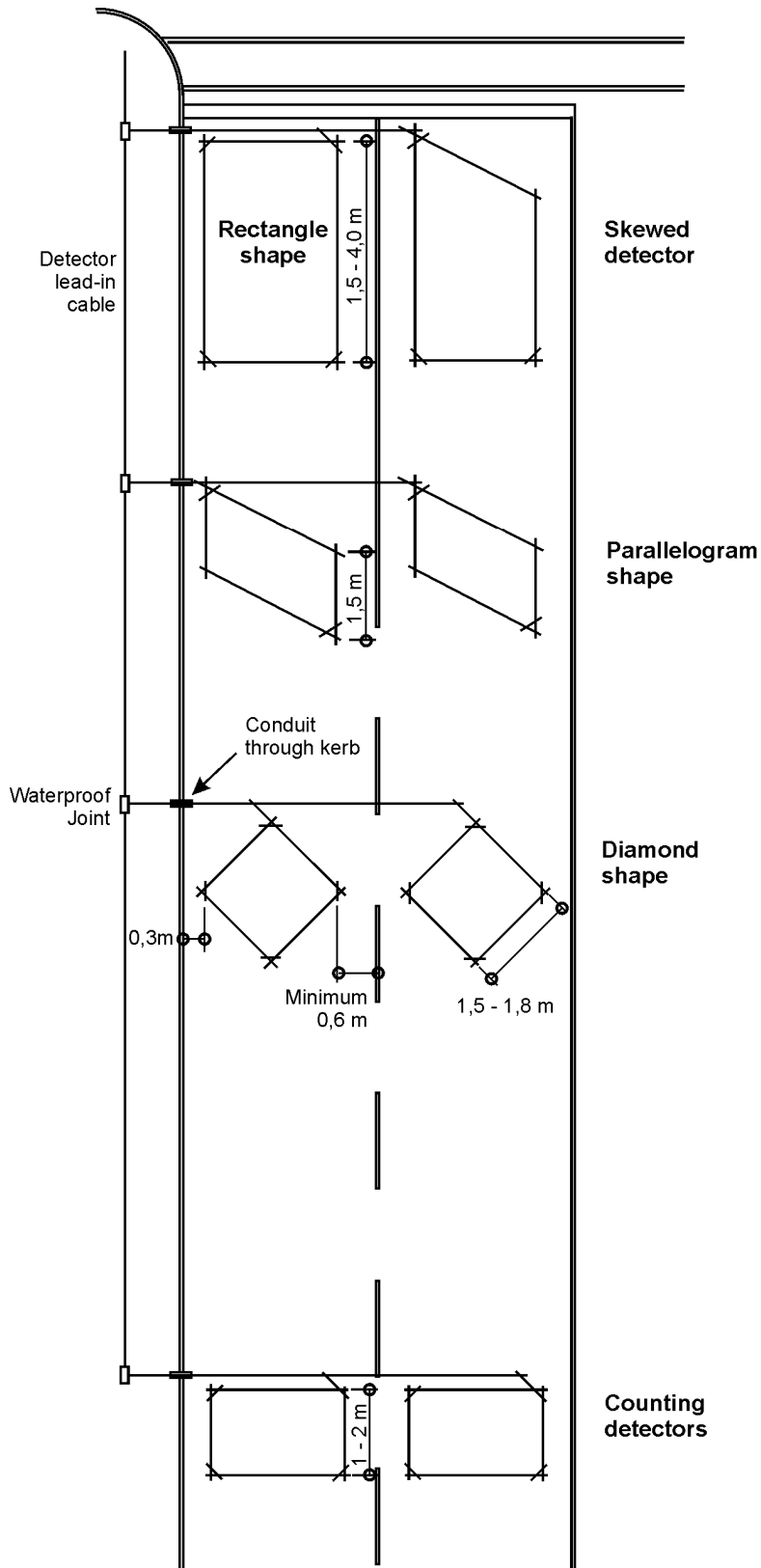

Figure 20.1: Inductive loop shapes and sizes

### 20.5.4 Loop installation procedure

- 1 Loops need to be properly and carefully installed to ensure trouble-free operation. The most common causes of failure are breakage of the wire or breakdown of the insulation, causing ingress of water and variations in resistance to earth and induction.
- 2 Great care should be given to ensuring that the slot is cut properly. The cut must be done at an even depth, particularly at corners where the cut must continue slightly beyond the end of the loop to accommodate the circular shape of the saw.
- 3 Slots should be cut in the road surface, using a diamond saw of suitable width. The slot should be free from any sharp edges that could damage the loop wire insulation and should be clean and dry before laying the loop. The use of compressed air to blow debris from the slot is highly recommended.
- 4 The wire should be laid in the slot without the application of undue pressure or force. Wire should not be pushed into the slot with a screwdriver or any other sharp instrument.
- 5 The loop wires and wire tails from the loop should be one continuous length of wire and joints should not be permitted. The wire tails are joined to the detector lead-in cable (DLC) and the joint should be encapsulated in a waterproof resin compound.
- 6 If there is a kerb, a hole must be drilled through or below the kerb and a conduit provided for the wire tails.
- 7 Loops at the same position from the stop line and connected to the same detector unit can be electrically connected in series (subject to a maximum limit that can be accommodated by the electronic circuit).

### 20.5.5 Prefabricated loops

- 1 Prefabricated loops can be used on roads that are subject to settlement or movement. The loops are prefabricated in a workshop and are installed as a single unit.
- 2 Various methods can be used for constructing such loops. These include the following:
  - (a) Installing loop wires in a 12 mm PVC conduit or pipe. All joints are sealed watertight.
  - (b) Encapsulating the loop wires in fibreglass. The loop is prefabricated on a frame and then wrapped with fibreglass fabric and treated with resin.
  - (c) Installing loop wires in a precast concrete slab of about 1,2 m square and 200 mm deep. An oversize hole is made in the pavement and the precast slab is installed with concrete backfill.
- 3 The slot for the prefabricated loop is made by making two saw cuts and chiselling out material between the two cuts.

### 20.6 BIBLIOGRAPHY

- 1 Institute of Transportation Engineers, 1997, Traffic detector handbook, Washington DC.
- 2 Institute of Transportation Engineers, 1985, Traffic detector field manual, Washington DC.

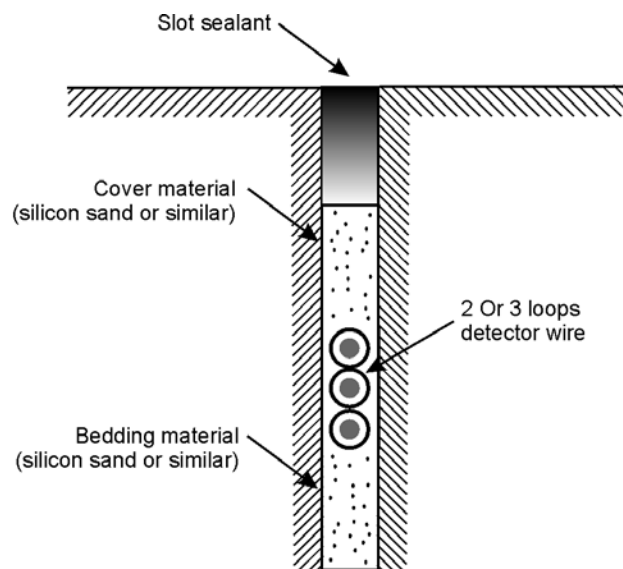

Figure 20.2: Inductive loop wire slot cut into the road surface

## CHAPTER 21: AUTOMATED LAW ENFORCEMENT

### 21.1 INTRODUCTION

- 1 The intention behind traffic law enforcement is to enhance the level of safety experienced by road users. Automated law enforcement can be used to supplement the law enforcement programme of a road authority.
- 2 The technology exists to capture an image in digital format and transmit it to a central computer. The identification of the erring vehicle can be identified by a technique such as number plate recognition. It is also possible to automate the dispatching of legal notices to owners of vehicles.
- 3 Many violations cannot easily be detected by automated detection techniques. These include roadworthiness, alcohol limits, reckless driving, frequent lane changing, etc. Some violations, however, can be detected automatically and some of these can be incorporated as part of the traffic signal system.
- 4 Unfortunately, the very ease with which automated law enforcement can be applied, may tempt traffic officials to abuse or overuse the system and bring it into disrepute, particularly when the automated law enforcement is unbalanced in relation to other, non-automated, law enforcement efforts.

### 21.2 VIOLATIONS AT TRAFFIC SIGNALS

- 1 Violations at junctions include:
  - (a) Turning from the wrong lane, or changing lanes in the junction area.
  - (b) Entering the junction when it is not possible to clear the junction area.
  - (c) Travelling at high speed through the junction.
  - (d) Entering the junction in the face of a red light signal.
- 2 Most automated law enforcement systems are installed for the detection of the last-mentioned violation, namely red light running. This violation is a major problem and is probably one of the major causes of serious accidents at traffic signals.
- 3 It is also possible to install automated law enforcement to detect speeding offences. Excessive speeding at signalised junctions could be dangerous, perhaps more so than on the street sections between the junctions. Red light running and speed enforcement can be combined in the same set of equipment.
- 4 The other violations are more difficult to detect using automatic detection systems.

### 21.3 IMPLEMENTATION

- 1 The development and maintenance of standards for all equipment used for law enforcement in South Africa is the responsibility of the Technical Committee for Standards and Procedures for Law Enforcement. This committee operates under the auspices of the South African National Departments of Transport and Justice.
- 2 Equipment used for automated law enforcement must comply with an appropriate South African Bureau of Standards specification. Information on available specifications can be obtained from the South African Bureau of Standards. The following are a number of examples of standards that are available:
  - (a) South African standard specification SANS 1795-0: *Speed measuring equipment Part 0: General*. Specify mechanical, electrical and operation requirements for speed measuring equipment that is intended for traffic law enforcement and prosecution purposes.
  - (b) South African standard specification SANS 1795-3: *Speed measuring equipment Part 3: Distance-over-time measuring equipment (fixed distance/variable time)*. Specifications that measure speed over a fixed distance.
- 3 The committee also issues prosecution guidelines that should be adhered to in law enforcement actions. Failure to comply with these guidelines could result in the withdrawal of cases.
- 4 The SABS specifications and prosecution guidelines address issues such as the position and type of equipment, and the data required to ensure successful prosecution. For red light running violations, for instance, the photograph of the vehicle must clearly show the position of the vehicle in relation to the stop line, as well as the red light signal. The date and time of the incident should also be captured by the equipment.



## CHAPTER 22: POWER SUPPLY

### 22.1 INTRODUCTION

- 1 Electrical power is essential at traffic signals for powering signal controllers, detectors, light signals and the central control system.
- 2 All electrical equipment in South Africa shall comply with the current requirements of:
  - (a) South African standard specification SANS 10142: *The wiring of premises*. A code of practice that covers general principles for the wiring of premises.
  - (b) South African standard specifications SANS 10199: *Design and installation of an earth electrode*. Covers methods used to earth electrical systems, including design, installation, testing and maintenance.
  - (c) Electricity Supply Commission (ESCOM) regulations and requirements.
  - (d) Any other requirements of the local authority.

### 22.2 ELECTRICAL REQUIREMENTS

- 1 A qualified electrician should properly test all electrical elements of a traffic signal installation. Wiring certificates stating that the tests have been successfully carried out should be signed by the electrician and kept on record.
- 2 All traffic signal components, including signal posts, should be properly earthed to an earth electrode or trench earth. This could even include components such as the door of the controller, by providing earth straps across the hinges. The preferred method of earthing is to run a bare copper conductor with the power supply cable in a trench (of relatively long length). Alternatively, earth spikes can be driven vertically into the ground in the trench bottom.
- 3 It is recommended that central control systems should be provided with an Uninterruptable Power Supply (UPS) unit with suitable capacity to ensure continued operation for a reasonable period, or until such time as emergency generator facilities can commence supply or full power is resumed.
- 4 At least one power socket should be provided within the controller cabinet to facilitate the operation of test equipment.

### 22.3 POWER SUPPLY CABLES

- 1 There are three distinct types of electrical cabling in traffic signal installations. They are:
  - (a) The mains power supply to the installation; the part up to the distribution board is usually provided by the electricity supply authority whilst the road authority is responsible for the part from that point to the controller.
  - (b) Cables connecting the signal lights to the controller. These are usually multi-core cables.
  - (c) Low voltage cables connecting inductive loop detectors to the detector units housed in the controller cabinet. Similar connections are provided for pedestrian push buttons.

- 2 During the installation of cables, provision should be made for some slack in the cables, particularly at the footing of each signal post, gantry, cantilever and the controller. Such slack is not only needed for maintenance purposes, but can also reduce the possibility of damage to the cable should a traffic accident occurs.
- 3 Joints in cables should be avoided as far as it is practically possible. No jointed cable should be pulled or drawn through a cable duct.
- 4 All external cables and wiring should be shaped to provide a drip loop before entry into equipment. An example of such a drip loop is shown in Figure 22.1.
- 5 Multi-core cables are used for connecting light signals to a controller. Each signal group requires separate cores to power the green, yellow and red light signals. Two or three live cores are required per signal face for this purpose (two are required for two-aspect signal faces such as pedestrian signals). One common neutral core can be used for all signals. The total number of cores required at a signal can be calculated by means of the following formula:

$$\text{Number of cores} = 2 + 2 \cdot N_2 + 3 \cdot N_3$$

In which  $N_2$  is the number of signal groups serving two-aspect traffic signal faces (including pedestrian signal faces), and  $N_3$  is the number of signal groups serving three-aspect signal faces.

- 6 The following additional number of cores are required when pedestrian push buttons are provided:

$$\text{Number of cores for push buttons} = 1 + N_p$$

In which  $N_p$  is the number of pedestrian signal groups.

- 7 The first formula given above, allows for one earth wire and one neutral wire in addition to the live wires required for each signal colour. The second formula allows for one neutral wire for push buttons.

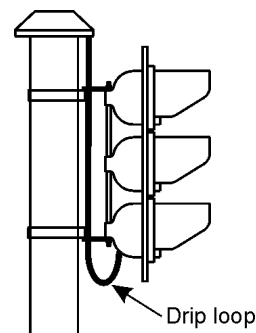

Figure 22.1: Drip loop on a power cable

- 8 Additional cores should be provided to allow for the possible expansion of signal groups in future. Where a turning phase is not currently provided, consideration can be given to providing an additional two or three cores for such purpose. Where pedestrian signals are currently not installed, additional cores may also be provided.
- 9 The method of cabling depends on the cost of cables and the type of cable held in stock by a road authority. Cables come in various sizes, such as 3-core, 4-core, 7-core, 12-core, 19-core, 27-core and 37-core.
- 10 The cabling method also depends on the junction layout as well as the cable ducts available at a junction. When a road is newly constructed, ducts should preferably be provided across all legs of a junction.
- 11 Different cabling methods have been developed and are used, such as the ring and radial systems. In the ring system, only one main core is used for all light aspects of a specific colour in one signal group. The main core is laid in a ring around the junction or crossing, and branch cores are used to provide power to individual light signals. In the radial system, a main core is used for each individual light signal – all branching occurs from the controller.
- 12 The ring system has the disadvantage that damage of the main core could cause the entire installation to be out of operation. The radial system, while more costly to implement initially, has considerable maintenance and functional advantages.

#### 22.4 TRENCHING AND DUCTING

- 1 Cables should be installed underground, for both operational benefits and aesthetic reasons.
- 2 All cables laid across roads and other paved areas should preferably be laid in ducts terminating in draw boxes. One or two ducts should be provided depending on the number of cables to be installed (also taking possible future requirements into account). An example of the provision of ducts and draw boxes at a junction is shown in Figure 22.2.
- 3 Cables should be pulled through the ducts manually and no mechanical means should be used for this purpose. Dry talc may be used to lubricate cables for pulling (grease should not be used).
- 4 A suitably marked yellow PVC or polythene *marker tape* may be laid in all trenches above the cables as a safety measure.

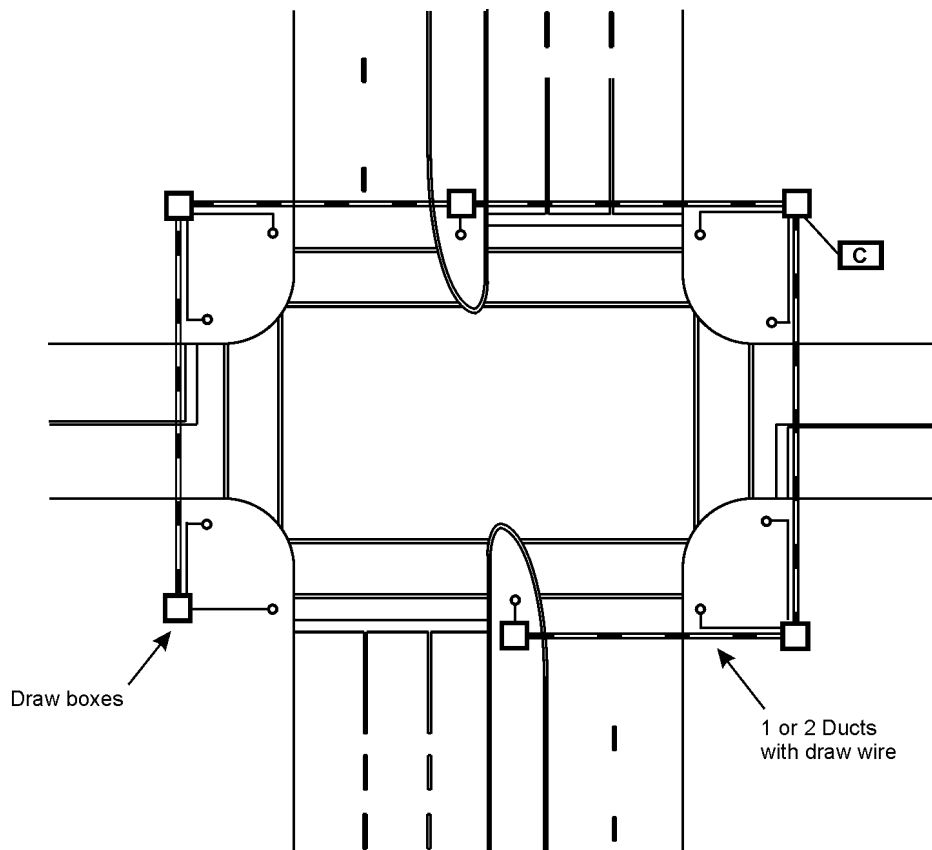

Figure 22.2: Example of duct and draw box layout at a junction

# **SOUTH AFRICAN ROAD TRAFFIC SIGNS MANUAL**

## **VOLUME 3: TRAFFIC SIGNAL DESIGN**

**DIGITISED VERSION – May 2012**

### **PART 3 TRAFFIC SIGNAL MANAGEMENT**

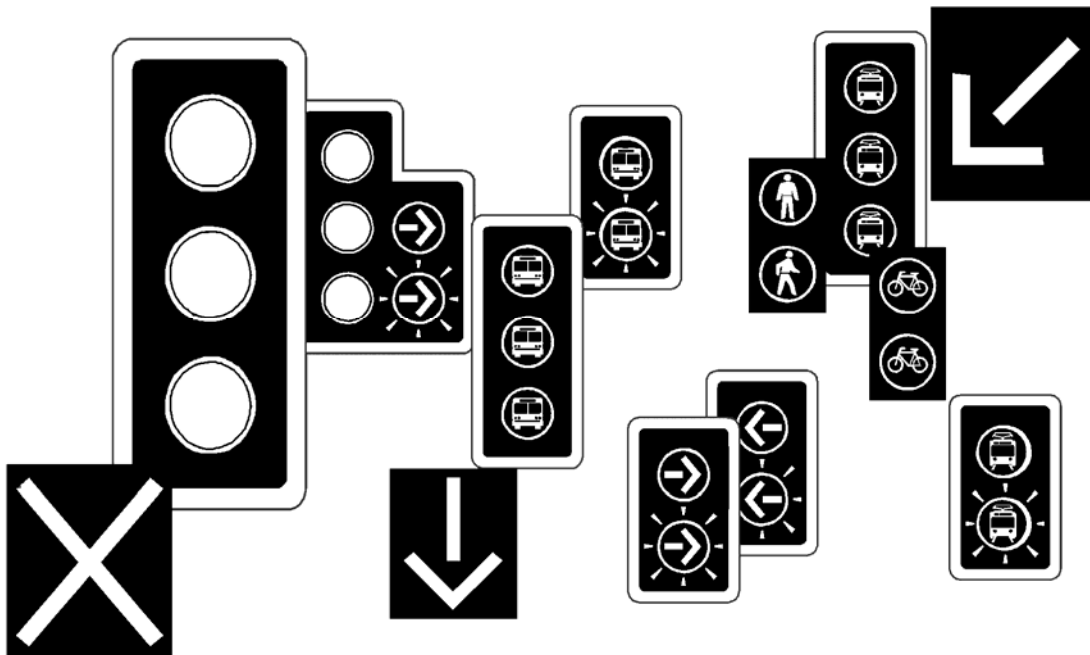





## CHAPTER 23: RESPONSIBILITIES AND DUTIES

### 23.1 INTRODUCTION

- 1 South African road authorities have powers and functions to provide and monitor roads and streets to promote mobility as well as economic development and to ensure efficient and safe operation of the road network. Traffic signals form an integral part of the transportation system and road network and are therefore the responsibility of the relevant road authority, or the designated authority to which the responsibility has been delegated.
- 2 A fundamental responsibility of a road authority is to ensure that traffic signal systems operate as efficiently and safely as possible. Traffic signals that are not properly installed, operated and maintained will severely affect traffic flow and could lead to an increase in traffic accidents.

### 23.2 INSTITUTIONAL RESPONSIBILITY

- 1 Road authorities in South Africa have permissive powers to maintain and repair roads and streets, although there is no specific obligation on an authority to undertake such duties. This, however, does not exempt a road authority, undertaking such duties, from the responsibility to ensure a safe road environment.
- 2 Traffic signals are specifically controlled by the National Road Traffic Regulations as well as the Road Traffic Signs Manual. Non-compliance to these regulations as well as the requirements contained in the manual can increase the risk of litigation in cases of loss of property, or injuries arising from accidents.
- 3 It is particularly important that standards and guidelines must be applied professionally and objectively, without undue influence by outside factors. Changes to standards that cannot objectively be quantified would increase the risk of litigation.
- 4 Road authorities should also introduce risk management programmes with the aim of reducing the possibility of litigation. Such programmes would encompass a variety of actions to ensure that standards are appropriately applied and to identify limitations in a system.
- 5 Road authorities also have the responsibility to ensure that traffic signal installation and maintenance are undertaken and controlled by professionals with appropriate levels of skills and knowledge. Failure to do so would be a failure of the duty of the authority.

### 23.3 INSTITUTIONAL CO-OPERATION

- 1 Traffic signal systems have become highly complex and intricate, requiring increasingly wider and more specialised skills of personnel involved with such systems. The complexity can be expected to evolve even more in the future, which will further increase the required skill levels. Such skill levels can more easily be provided when different road authorities co-operate institutionally, providing an integrated signalisation service.
- 2 In many cases, traffic signal operations can be expected to extend across several jurisdictions, which makes it imperative that different road authorities should co-operate in the field of traffic signalisation. The utility and efficiency of signals can be improved by integrating traffic signal systems.
- 3 **Co-operation is particularly important amongst smaller road authorities. Where road authorities control less than 200 traffic signal installations, it is strongly recommended that, where possible, such road authorities co-operate and fund a combined traffic signal division. Even larger road authorities should co-operate where it is possible to provide an integrated traffic signal system.**
- 4 High priority should be given by all road authorities to institutional co-operation. Such co-operation can easily be achieved, with a minimum of investigation and research.

### 23.4 SIGNAL MANAGEMENT

- 1 Communication within a road authority and with outside entities is an important management function. Good relations with the public are also essential, particularly when problems arise with traffic signalling.
- 2 Each authority should establish an ad-hoc traffic signal committee with the purpose of managing all aspects related to traffic signals, including applications or requests for new traffic signal installations.
- 3 The traffic signal committee should consist of the following members:
  - (a) Manager of the traffic signal division.
  - (b) Representatives of the traffic police.
  - (c) Representatives of road and transportation departments, particularly those involved with the planning and design of roads.
  - (d) Representatives of any other department that provide a service or who may be affected by traffic signals.
- 4 The traffic signal committee would be responsible for overseeing the traffic signal division and to ensure that traffic signals are installed and maintained with the highest level of proficiency and responsibility. The committee may also assist with funding and budget control.
- 5 **The committee should also review the geometric designs of all new road and junction proposals in order to ensure adequate provision is made for possible future signalisation.**



## CHAPTER 24: RISK MANAGEMENT

### 24.1 INTRODUCTION

- 1 Road authorities undertake work that carries a substantial risk of litigation resulting from cases of loss of property and injuries arising from accidents (collisions). It is therefore imperative that risk management procedures should be introduced in order to minimise the potential for accidents, thereby reducing the risk of litigation and being held liable for damages.
- 2 In South Africa, road authorities have permissive duties to provide, maintain and repair roads and related facilities, but are under no obligation to do so. There can thus be no liability for damages occasioned by non-performance of powers which are merely permissive. Where, however, a road authority undertakes such work, it would be liable for any damages caused by its negligence, even where no obligation rests on the authority to undertake such work.
- 3 A road authority has an active duty to guard against introducing a new source of danger when undertaking work on a road or street. The condition after completion of work should not be more dangerous than before the work was undertaken.
- 4 An important consideration is that a road authority cannot ensure absolute safety to the user of the road system. There is a limit to the measures that can be introduced to improve road safety and the road user also has some responsibility in this regard.
- 5 In the United States of America, all liability suits are founded in a particular area of law, called *tort* law. A tort is a private or civil wrong that results in injury or loss caused by the *tortious* acts of a person or a legal body. In South Africa, the delictual liability for damages caused by a person's actions is governed by common law.
- 6 In South Africa, liability suits have thus far been less common than in the United States. The outcome of liability cases in South Africa depends on the facts of each case and cannot be predicted with certainty as applicable laws and principles develop and change over time. However, although cases to date have not been unreasonable in their verdicts, it is apparent that a road authority that does not adhere to legislation and guidelines leaves itself open to expensive liability suits.

### 24.2 STANDARDS AND GUIDELINES

- 1 Traffic signals are specifically controlled by National Road Traffic Regulations as well as the Road Traffic Signs Manual. Non-compliance to these regulations as well as the requirements contained in the manual will increase the risk of litigation and the possibility that the road authority will be found in neglect of its duty.
- 2 Non-compliance with the National Road Traffic Regulations is a criminal offence and may lead to criminal prosecution being instituted against a road authority.
- 3 Standards and guidelines must be applied professionally and objectively, without undue interference by outside influences. It is unlikely that the standards and guidelines will be questioned, as well as deviations that were justified objectively. Arbitrary deviations that cannot be justified objectively, however, would increase the likelihood of an authority being found in neglect. On the other hand, "going by the book" may not be sufficient and additional consideration may be required to ensure safety over and above that provided by the minimum prescribed standards.
- 4 A particularly important requirement of the National Road Traffic Regulations is that a professional engineer or technologist must approve traffic signal installations. It must furthermore be designed in accordance with the regulations and the Road Traffic Signs Manual. Non-compliance with the regulations could be interpreted as an abuse of the duty of the road authority and could create liability.
- 5 A road authority can use its discretion in selecting amongst alternative solutions, as long as all the alternatives meet the required standards and guidelines.
- 6 Even if the standards and guidelines have been properly followed when the traffic signal was installed, it is the duty of road authorities to ensure that a design does not become manifestly dangerous following its adoption. Road authorities may not have an ostrich-like approach in which problems are ignored with the hope that they will disappear.
- 7 At traffic signals, it is imperative that operations should be reviewed immediately after installation, or after any changes that materially alter the operations of signals, to determine if the changed conditions have not inadvertently resulted in dangerous conditions. Failure to do so would increase the risk of liability.

### 24.3 NOTICES OF DEFECT

- 1 Knowing about a problem means that a road authority has been given notice that a problem exists. A notice of a problem creates the duty for the road authority to remedy a defect or face liability risk when operations are continued without addressing the problem. Negligence stems from notice of a defect and the subsequent failure to safeguard against the consequences of the defect.
- 2 A road authority may receive *actual* or *constructive* notices of a defect. An *actual* notice occurs when an authority has received communications from the public or its own employees. A *constructive* notice occurs when the authority should have known of a defect.
- 3 A particularly important constructive notice is an actual notice that was given to an authority, but which was not handed over to the traffic signal division. It is unlikely that internal communication problems would be treated as a mitigating consideration - it is the responsibility of authorities to ensure that such communication problems do not exist amongst departments or divisions. A local authority is treated as a legal entity, but not its internal departments. Passing blame from one department to another will not assist a case – in most cases, it will aggravate the matter as it shows the lack of proper management and care.
- 4 A constructive notice would also occur when an employee of the traffic signal division has been in a position to observe a problem. In such a case, it would not even be necessary for the employee to have notified the road authority about the problem, since this would be treated as an internal communication problem that should have been addressed by the authority.
- 5 Constructive notice can also arise if the road authority has allowed a problem to exist for an unreasonable period of time without taking action. It may be found that the road authority had sufficient time to discover the problem if they were acting in a reasonable prudent manner. An unreasonable period of time would among other things, depend on the nature of the problem, the extent of the danger to the public and the financial situation of the authority.
- 6 Constructive notice also occurs when the road authority did not follow required standards and guidelines, even if they were not aware of the existence of such standards and guidelines. It is incumbent on a road authority that it is aware of the latest standards and guidelines. The authority has created the problem, therefore they have constructive notice and they could be negligent in this regard.
- 7 *Repeat accidents*, particularly if of a similar nature, can also be construed as constructive notice of a defect at a traffic signal installation. Accident statistics should be reviewed on a regular basis with the purpose of identifying signal installations where such repeat accidents occur.

### 24.4 CONSTRUCTION AND REPAIR

- 1 The construction and repair of a facility are considered to be a simpler operation than design, and it is therefore more likely that a road authority will be found in neglect for deficiencies during the construction or repair of a signal installation, even if the driver was mostly to blame for an accident.
- 2 Lapses in the provision of appropriate protective measures during the construction or repair of a traffic signal installation would probably result in a relatively simple negligence suit. It would be simple because the elements of the suit would be easy to prove, particularly that the breach of duty owed to the road user by a road authority, was the proximate cause of the accident, even if a driver had some duty to take due care.
- 3 Road authorities should be aware that in the employment of contractors, their basic responsibility to maintain roads in a reasonably safe condition can not be contracted away. The road authority should implement appropriate procedures to ensure that contractors abide by safety requirements. Contractors should be treated as if they are contracted employees.

### 24.5 RISK MANAGEMENT STRATEGY

- 1 A risk management strategy should address possible risks of failure resulting from all phases over the full life cycle of a project (planning, construction, maintenance and operations). It is particularly important that appropriate standards and guidelines be complied to, while steps should be instituted to ensure that faults and defects are speedily attended to.
- 2 **The most important method of reducing the risk of litigation is by employing personnel with the required skills and knowledge to ensure the safe operation of traffic signals.**
- 3 Good records are the foundation of any good risk management programme as they can provide a good defence for actions against a road authority. However, the same records can be used against the road authority when appropriate responses have not been taken or when notice of a defect is observed in the records. Such notice would indicate that the authority had knowledge of a defect, and that it failed to eliminate a known defect.
- 4 A good risk management programme would include appropriate preventative procedures for the identification of possible defects, either in the design or in the operation of traffic signals. The preferred procedure is one which seeks out problems by inspection and which does not rely entirely on complaints from the public or the police. This programme should not only seek out the problems, but should also address the need to rectify the problems.
- 5 Where there is a priority list for repairs or improvements, it is important that a road authority should not deviate from this list when there is no rational reason for such deviation. The priority list should also be established using rational and objective criteria.

- 6 Provision should be made for a 24-hour response to rectify emergency faults. It is not necessary to repair a fault immediately, as long as steps have been taken to safeguard a situation or to erect adequate warning signs. It must, however, be understood that temporary measures cannot be left indefinitely and that permanent repairs should be completed within a reasonable period of time. An authority leaving a traffic signal in flashing mode for days on end could find itself open to claims in the event of accidents.
- 7 An essential aspect of fault response procedures is to institute procedures whereby complaints are received and passed through appropriate channels. Appropriate records should be kept of such complaints as well as the responses to the complaints.

#### **24.6 PERSONAL LIABILITY**

- 1 Employees of road authorities are normally protected against liability suits while working within the scope of their employment. However, where gross negligence can be proven, it may be possible that such protection will fall away, or that the road authority itself could institute litigation against the individual concerned.
- 2 In the private sector, consulting engineers and contractors are most vulnerable. They have none of the protection available to employees of the public sector. Under these circumstances, there is a definite need for consulting engineers and contractors to obtain liability and professional indemnity insurance. A road authority should, in fact, insist on such insurance as part of the contract between the authority and the consultant or contractor.
- 3 Alternatively, a road authority can agree to indemnify consultants and contractors from any claims once traffic signals have been commissioned and approved by the responsible engineer or technologist of the road authority. Such indemnity should be part of the contract between the road authority and the consultant or contractor.



## CHAPTER 25: MANPOWER REQUIREMENTS

### 25.1 INTRODUCTION

- 1 The availability of knowledgeable and skilled professionals and technicians is an important prerequisite for effective and safe traffic signalisation. Traffic signal installations have become highly complex and their impact can impede traffic operations substantially. It is therefore important that priority should be given to ensuring that the highest levels of skill be employed by road authorities.
  - 2 In this chapter, minimum skill levels and educational requirements are discussed for professionals involved with traffic signals. Attention is also given to minimum staffing requirements and the utilisation of consulting engineers and contractors.
  - 3 Differentiation is made between the two main professional disciplines involved with traffic signals, namely traffic and electrical/electronic engineering. The traffic engineering discipline is involved with traffic operations and the setting of traffic signals, while the electrical and electronic engineering discipline is more involved with the installation, wiring and maintenance of the signals.
  - 4 A third discipline not covered in this chapter is the civil engineering discipline. At a signalised junction, this discipline would be involved with all work related to aspects such as the provision and construction of the road pavement, drainage structures, earth works, road signs, etc.
  - 5 The traffic and electrical/electronic disciplines directly involved with traffic signalisation should preferably be located within one traffic signal division. There is a definite need for a close relationship between the two groups.
  - 6 Larger road authorities are probably in a position where they can employ some of the professionals required from both professional disciplines, although they may have to supplement their own staff levels by appointing consulting engineers or contractors. Smaller road authorities, however, would not have sufficient numbers of traffic signals in operation to warrant the employment of such a range of professionals, and would therefore have to rely on consulting engineers and contractors to supply the necessary services.
- 2 Distinction can be made between the following three levels of professionals involved with traffic engineering work:
    - (a) Professional engineers.
    - (b) Professional engineering technologists.
    - (c) Support personnel such as technicians, computer programmers, CAD (computer aided design) operators and administrative staff.
  - 3 Both the professional engineers and the professional engineering technologists should have received specialist training specifically in the discipline of transportation and traffic engineering, and should preferably have postgraduate qualifications in this discipline.
  - 4 Professional engineers would normally be responsible for functions such as:
    - (a) Management and control of the traffic signal department or division (including the electrical and electronic section).
    - (b) Development of methods, procedures and standards and the investigation of new or alternative traffic signalisation techniques.
    - (c) Overall control of functions such as signal design, intersection layout, traffic data collection, etc.
    - (d) Provide guidance in the design of more complex signal installations, central control, signal co-ordination, non-standard intersection layouts, etc.
    - (e) Prepare and review traffic management plans, including traffic impact studies.
  - 5 Professional engineering technologists would normally be involved with the functions of signal design, intersection layout, traffic data collection, traffic signal configuration, etc. In addition to these, technologists can also become involved with the other functions identified above.
  - 6 The work of the traffic signal division would include tasks such as:
    - (a) Overall management of the traffic signal division, including budget control and reporting.
    - (b) Traffic data collection, including traffic volumes, speeds, saturation flows, accident rates, etc.
    - (c) Conceptual design and layout of signalised junctions.
    - (d) Design of traffic signal layouts, timings, phasing, and the co-ordination of traffic signals.
    - (e) Warrant studies for the installation of new traffic signals.
    - (f) Prioritisation of new installations and upgrading of existing installations.
    - (g) Investigations into new traffic signal control systems.
    - (h) Development of methods, procedures and standards.

### 25.2 TRAFFIC ENGINEERING

- 1 Traffic engineering professionals are those skilled in ensuring the safe and efficient flow of traffic through a signalised junction or crossing. These professionals would normally be involved with tasks such as warranting signal installations, the design and layout of signalised junctions and crossings, establishing traffic signal timing and phasing, signal co-ordination, and the collection of traffic data.

### 25.3 ELECTRICAL AND ELECTRONIC ENGINEERING

- 1 Electrical and electronic engineering professionals are those skilled in the electrical and electronic aspects of traffic signals. Most modern traffic signals involve the use of digital electronic devices and advanced telecommunication and data transmission systems; the installation, maintenance and repair of which require specialist knowledge in the discipline of electronics. All electrical work at a signal should also only be carried out by a qualified electrician.
- 2 It would normally not be necessary to involve professional engineers in the electrical or electronic side of signals. The following skill levels would typically be required for this purpose:
  - (a) Professional engineering technologists.
  - (b) Qualified electricians.
  - (c) Electronic technicians.
  - (d) Line workers.
  - (e) Worker assistants.
  - (f) Administrative staff.
- 3 The professional engineering technologists should be qualified in the disciplines of electrical and electronic engineering. The technologists will be responsible for the management and control of the electrical and electronic side of traffic signals.
- 4 The electricians will be responsible for the maintenance and repair of electrical components while electronic technicians will be responsible for electronic components of traffic signals. Line workers will undertake tasks such as lamp replacement, cleaning of lenses, painting of posts and alignment of signals. All three groups may be assisted by worker assistants.
- 5 The task of the electrical and electronic section includes:
  - (a) Management, supervision and control of all aspects related to the electrical and electronic side of traffic signals.
  - (b) Management and control of personnel, material, spares and tools.
  - (c) Keeping of records of all activities and inventory controls.
  - (d) Budgeting for new installations, maintenance and repair as well as controlling such budgets.
  - (e) Installation, maintenance and repair of all traffic signal equipment, including controllers and computers.
  - (f) Planning and scheduling of traffic signal installation, upgrading, modification, maintenance and repair.
  - (g) Management, supervision and control of installation and maintenance contracts undertaken by private contractors.
  - (h) Inspection of installations during various stages of completion and final acceptance on contract completion.
  - (i) Investigations into new developments in the discipline of signalisation.
  - (j) Providing advice to traffic engineers on the capabilities and limitations of traffic signal equipment.

- (k) Planning and implementing maintenance and upgrading programmes. Developing procedures for the establishment of maintenance and upgrading priorities.
- (l) Training of personnel in all electrical and electronic related aspects of traffic signals.
- (m) Appearing as expert witnesses in litigation involving the electrical and electronic aspects regarding operation and maintenance of traffic signals.

### 25.4 STAFFING LEVELS

- 1 In this section, broad guidelines are provided on staffing levels required to run a traffic signal division. Exact and detailed guidelines cannot be provided since the required staffing levels depend on a variety of factors, such as the number and age of traffic signal installations, the utilisation of Area Traffic Control (ATC) systems, the complexity of traffic patterns in an area as well as skill levels of available personnel. It is thus not possible to compare staffing levels of two road authorities, even if they control exactly the same number of signalised junctions.
- 2 A general indication of desirable staffing levels is given in Table 25.1 in terms of work-hours per signalised junction or crossing. The staffing levels for a particular road authority can be estimated by means of the following formula (in which it is assumed that a person works 1 760 hours per annum):
 
$$\text{Staffing level} = \frac{\text{Work hours} \times \text{No of Signals}}{1760}$$
- 3 A road authority does not have to employ all the personnel indicated in Table 25.1, but can opt to appoint consulting engineers and contractors on a contractual basis.

**TABLE 25.1: DESIRABLE STAFFING LEVELS**

| Qualification  | Work-hours per signal |
|--|-----------------------|
| <b>Traffic engineering discipline</b>                                |                       |
| Manager/ Professional traffic engineers                              | 8,0                   |
| Professional traffic engineering technologists and technicians       | 24,0                  |
| Traffic engineering administrative staff                             | 4,0                   |
| <b>Electronic and electrical engineering discipline</b>              |                       |
| Manager/Foremen  | 6,0                   |
| Qualified electricians   | 20,0                  |
| Electronic technicians   | 6,0                   |
| Line workers   | 12,0                  |
| Worker assistants  | 40,0                  |
| Administrative staff (including operators of fault report telephone) | 6,0                   |



- 4 **Road authorities controlling 200 or more signal installations should have a traffic signal division and employ the full complement of staff, including at least one professional traffic engineer and one professional electronic and/or electrical engineering technologist.**
- 5 **Smaller road authorities should where possible co-operate with each other and form a combined traffic signal division, with the full complement of staff as discussed above. Even larger road authorities may co-operate and provide a combined traffic signal division with the purpose of sharing resources.**
- 6 Where it is not possible to combine resources, small road authorities controlling 50 signal installations or less, may utilise a qualified electrician for general low-level maintenance of traffic signals. Such road authorities would rely on consulting engineers and contractors to provide the other required services.
- 7 Road authorities controlling between 50 and 200 signal installations should employ at least one professional traffic engineering technologist and one qualified electrician with specialist knowledge of traffic signals.
- 8 Even if a road authority has an adequate staffing level, it is recommended that traffic engineering consultants be employed to provide expert advice. Authorities should always be aware of the danger of stagnation within the signal divisions, and should implement measures that would ensure that personnel are always informed of the latest available methods and technology.

## **25.5 EDUCATION AND TECHNOLOGY TRANSFER**

- 1 The continued education and transfer of skills and knowledge to personnel involved with traffic signals are of fundamental importance to ensure efficient and safe signal operations, and to allow personnel to be aware of the rapid development in the discipline of signalisation. Very high priority should be given to education and technology transfer.
- 2 Road authorities must be made aware of the levels of knowledge and skills necessary to perform the broad range of functions required and the consequence of not providing the requisite training and technology transfer programmes.
- 3 It is also the responsibility of road authorities to ensure that adequate training and technology transfer programmes are available to their personnel, consultants and contractors. Where necessary, road authorities can fund educational or other institutions for the development of such courses.



## CHAPTER 26: TRAFFIC SIGNAL INSTALLATION

### 26.1 INTRODUCTION

- 1 The installation of traffic signals requires a significant amount of planning and design by skilled and knowledgeable professionals. A high degree of attention to detail is required. Often, the cost of planning and design is high, compared with the cost of the traffic signal installation itself, but the benefits far exceed such cost.
- 2 Warrants for the installation of traffic signals are given in Chapter 2 of this manual. The installation is warranted when the traffic signals can a) meet all the *minimum requirements* as described in this manual, b) no viable and feasible *alternative solution* is available which, when implemented, would obviate the need for traffic signals and c) the traffic signals meet the minimum *queue length warrants*.
- 3 The investigation of signal sites and installation of traffic signals require the following tasks:
  - (a) Candidate site identification.
  - (b) Warrant study.
  - (c) Signal design.
  - (d) Signal installation.
  - (e) Commissioning.The road authority accepts responsibility for traffic signal operations during the commissioning phase of the project.
- 4 Checklists are given in Appendix C to this manual that can be used for checking signal designs and for approving of traffic signals. The checklists should be signed by the responsible registered professional engineer or technologist of the road authority.

### 26.2 CANDIDATE SITE IDENTIFICATION

- 1 Candidate locations for the installation of traffic signals can be identified by means of a variety of methods. Many locations are identified following requests from the public or decision-makers. Traffic engineers and technologists in the employment of a road authority can also contribute in this regard.
- 2 The queue length warrant used for justifying the installation of traffic signals is a simple method of identifying possible locations for signalisation. Observations over a short period of time during peak hours at a junction or a pedestrian crossing would indicate the presence of long queues of vehicles.
- 3 A site should initially be inspected visually to establish whether it is likely that the installation of traffic signals would not be warranted. During this inspection, attention should be given to the minimum requirements for the installation of signals.

### 26.3 WARRANT STUDY

- 1 Once a candidate site for signalisation has been identified, a study should be undertaken to establish whether the installation of traffic signals would be warranted according to the requirements of Chapter 2 of this manual.
- 2 The study must start off by establishing whether a traffic signal can be installed without violating the minimum requirements for traffic signal installations as set out in this manual. The installation of traffic signals would not be warranted when any of the minimum requirements cannot be met.
- 3 The next step in the warrant study is to establish whether no viable and feasible alternative solution other than traffic signals is available which, when implemented, would obviate the need for traffic signals. Traffic signals would not be warranted if such a solution is available.
- 4 The final step in the study is to undertake a queue length study to establish whether the queue length warrants given in Chapter 2 will be met. A traffic signal installation would be warranted if the site passes this final test.
- 5 When a traffic signal is warranted, the site can be placed on a priority list until funds become available for the installation of the signal. Priority should be given to those locations with the longest queues (as measured during the warrant study).

### 26.4 SIGNAL DESIGN

- 1 Once a traffic signal has been warranted at a junction or crossing, the design of the signal can proceed. Traffic studies should be undertaken, the site must be surveyed and the traffic signal designed. Contract documents and specifications will also be required if a contractor undertakes the work.
- 2 A proper land survey should be made of the site showing all relevant information such as:
  - (a) Property boundaries and fences.
  - (b) Carriageways, kerbs, shoulders, islands, medians, existing road markings.
  - (c) Paved sidewalks, driveways.
  - (d) Drainage structures.
  - (e) Plants and vegetation (including location, size and spread of larger trees).
  - (f) Engineering services (telephone, electricity, water, sanitation, etc).
  - (g) Roadside furniture such as bus shelters, telephone booths, retaining walls, guard rails and light poles.
  - (h) Adjacent buildings together with any awnings, height above the kerb and distance back from the kerb face.
  - (i) Any other structures such as bridges, retaining walls, fills and cuts, etc.

- 3 It is important that attention should be given to the possible geometric improvement of a junction during the design phase. Particular attention should be given to the provision of auxiliary turning lanes, particularly right-turn lanes, but also possibly left-turn lanes. Auxiliary straight-through lanes may also be required.
- 4 The site should be regularly visited and inspected during the design stage to ensure that the plan will be satisfactory. Checks should be made during such visits to ensure that the survey included all relevant information. **It is the responsibility of the design engineer or technologist to ensure that the survey was undertaken correctly.**
- 5 During the site visits, attention should be given to possible problems such as:
  - (a) Inadequate space for traffic signal placement.
  - (b) Available sight distances on all approaches and for all turning movements.
  - (c) Distance to adjacent traffic signal sites.
  - (d) Location of any nearby emergency services that may require priority.
  - (e) Most appropriate location for the controller.
  - (f) Condition of road pavement for installation of loop detectors.
  - (g) Source of supply of power.
  - (h) Parking spaces for signal maintenance vehicles.
- 6 It would be beneficial if a qualified electrician could also inspect the site to identify any possible electrical problems that may occur. The actual source and availability of power must be confirmed.
- 7 Proposed designs should be discussed with all parties with an interest in the design to ensure agreement. This includes the electronic and electrical engineers and other departments of the road authority. Where other authorities are also affected, it is particularly important that they should form part of the process from the outset of the project.
- 8 Design plans should contain full information on all details related to the traffic signal. Fewer problems can be expected during installation if sufficient care has been taken during the design phase. Designs should also take future maintenance needs into account. It may be possible to introduce a number of relatively simple design features that could reduce maintenance costs substantially.
- 9 The following design plans would normally be required:
  - (a) Junction or crossing design showing the geometric design, road signs and markings.
  - (b) Traffic signal layout plan showing the location of traffic signal faces, signal posts, overhead gantries of cantilevers, loop detectors and the controller.
  - (c) Duct diagram, indicating the position of ducts and draw boxes.
  - (d) Existing engineering services plan, indicating which services have to be relocated.
  - (e) Traffic signal timing and phasing diagrams.

## 26.5 SIGNAL INSTALLATION

- 1 Successful traffic signal installation depends on effective supervision and control during installation. A high degree of supervision is required to ensure that the signal is installed according to specifications.
- 2 Installation can either be done by the road authority or by private contractors. Larger road authorities that install traffic signals regularly would probably install signals departmentally. Smaller road authorities would need to appoint private contractors for such work.
- 3 The utilisation of qualified and experienced contractors can significantly reduce the possibility of installation faults. The possibility of future liability resulting from such faults should be an important consideration when selecting contractors. Preference should be given to contractors with the required experience, skills, knowledge and resources to complete a project.
- 4 A suitably qualified person should be assigned by the road authority to be responsible for direct supervision of signal installation contracts. Electrical work should be inspected and approved by a qualified electrician.
- 5 Before commencing with installation, the contractor should submit a detailed timetable or schedule in advance for approval by the project engineer or technologist. The typical installation sequence for traffic signal installations is:
  - (a) Civil engineering work
  - (b) Underground.
    - (i) Footings.
    - (ii) Ducts and draw boxes.
    - (iii) Cables, earthing and wiring.
    - (iv) Detector loops.
  - (c) Above ground.
    - (i) Signal posts and overhead installations.
    - (ii) Traffic signal heads.
    - (iii) Electrical wiring and conduits.
    - (iv) Cabinet and control equipment.
    - (v) Electrical connection.
  - (d) Testing of installed signals.
- 6 Particular attention must also be given to the **accommodation of traffic** during the installation. Traffic signal faces should be masked, and existing controls maintained at the junction. The possibility of liability claims resulting from accidents should always be a prime concern.
- 7 During the contract, adequate records must be kept of the progress with the installation of the signals. Any delays must be carefully documented and reported. A daily diary should be kept in which all events and relevant information are logged. The information can be summarised in a number of status reports.
- 8 Any changes to the initial design should be properly authorised and logged (using variation orders). Changes may cover such items such as increased or decreased quantities, design alterations, equipment substitution, etc.

## 26.6 COMMISSIONING

- 1 Before a traffic signal is finally commissioned, it is imperative that the installation be properly checked and inspected, and traffic signal operations reviewed.
- 2 During this check, all signal plans should be tested and light signals inspected for proper operation. Once the proper operation of traffic signal equipment has been ascertained, traffic operations should be tested for a short period of time for possible serious traffic conflicts. A traffic officer should be present during the testing period.
- 3 A commissioning checklist is provided in Appendix C to assist with the commissioning of a signal. The checklist should be used as a supplement to, and not as a replacement for, the contract specifications and specific instructions of product manufacturers and suppliers. The checklist should be signed by the responsible registered professional engineer or technologist of the road authority.
- 4 It is important that the traffic signal should be monitored after it has been brought into operation. Traffic patterns may change as a result of the signal installation, while drivers may not respond to signals as anticipated.
- 5 Changed traffic patterns will require updating of traffic signal timings once traffic patterns have stabilised. At least one month should be allowed for traffic to stabilise. Traffic may then have to be recounted and new traffic signal timings and phasing determined. The provision of turning phases may even require modifications to the traffic signal face layout.



## CHAPTER 27: REMOVAL OF TRAFFIC SIGNALS

### 27.1 INTRODUCTION

- 1 Traffic operations at traffic signals should be periodically reviewed to establish whether the signal still meets the objectives of providing safe, convenient and affordable traffic control with a minimum of environmental side effects. This includes ensuring that the level of control at any junction is appropriate to the circumstances prevailing at that junction. For example, vehicles standing in queues at a junction without any cross flow are needlessly consuming energy, polluting the atmosphere with exhaust emissions and wasting time.
- 2 Warrants for the removal of a traffic signal are given in Chapter 2 of this manual (Volume 3). The traffic signal should be replaced by another more appropriate form of control such as a traffic circle when the removal of the signal is warranted.
- 3 In this chapter, attention is given to procedures that should be followed in removing traffic signals. It is important to note that, where design and signage would typically be geared to the needs of a driver unfamiliar with an area, removal of traffic signals would typically require attention being given to the needs of the familiar driver. The unfamiliar driver will respond to whatever circumstance confronts him or her at a junction, whereas the familiar driver is more likely to respond to whatever used to be the situation and not necessarily the changed situation.

### 27.2 IDENTIFICATION OF SIGNALS REQUIRING REMOVAL

- 1 The identification of signals requiring removal is more complex than the identification of locations where new signals are required. The reason for this is that signals will still operate fairly efficiently, even if they are no longer warranted.
- 2 It is possible to undertake regular comprehensive studies of all the junctions and crossings in the network to establish whether signals are still warranted. The cost of such studies, however, is high and such detailed studies are not required.
- 3 The queue length warrant used for justifying the removal of traffic signals is a relatively simple method of identifying possible locations for signalisation. If queues are generally short at a traffic signal, it may indicate that the signals are no longer warranted. It is, however, important to note that long queues at signals are not necessarily an indication that the signals are warranted – the long queues may be caused by poor traffic signal settings.
- 4 It is unlikely that signals on arterial roads carrying high volumes of traffic would have to be removed. It may be necessary to upgrade traffic signal settings to allow for increases in flows and changes in turning patterns.

- 5 The likely candidates for removal would be those on local roads carrying low volumes of traffic. In many cases, such signals were not warranted in the first place, or were only marginally warranted.
- 6 It is important to note that the removal of a traffic signal does not constitute an admittance that poor planning practices were applied, but rather that circumstances have changed. Urban areas are dynamic and control measures cannot remain static in time. Changes to the road network, in particular, can contribute significantly to such changes.

### 27.3 REMOVAL PROCEDURE

- 1 The removal of traffic signals should be undertaken with care. Drivers tend to be inattentive, and the sudden removal of traffic signals can result in traffic accidents. It is therefore essential that such drivers be made sufficiently aware of impending change.
- 2 The following procedure should be followed when removing traffic signals:
  - (a) Provide information to the public over a period of about 2 weeks. Install information road traffic signs containing information on the intended removal of the signals.
  - (b) Place signals in flashing mode for 1 or 2 days.
  - (c) Implement new form of control and mask traffic signals for a period of at least 7 days. A warrant study can be undertaken during this time to reconfirm whether signals are actually no longer required at the junction.
  - (d) Remove traffic signals together with any road and information signs.
- 3 Use should be made of all available avenues for informing the public of the impending removal of a traffic signal. These include press releases and radio announcements. Information signs should also be installed on each approach leg to a traffic signal. The date of removal should be given, possibly together with a countdown in days to the date of the intended removal.
- 4 It is essential that proper record be kept of the change process. This includes dated and properly annotated photographs of the junction throughout the process, commencing with the date at which the information signs were installed. Such records will be required in cases of accidents to indicate that due diligence and care have been taken.
- 5 The removal procedure provides for a warrant study as an additional measure of reconfirmation that existing signals are indeed no longer warranted. When it is found that the signals are indeed still warranted, alternative means of improving or upgrading the junction should, however, be explored before the signals are reinstalled.





## CHAPTER 28: TRAFFIC SIGNAL MAINTENANCE

### 28.1 INTRODUCTION

- 1 Adequate maintenance of traffic signals is essential for proper operation. Neglect can lead to danger to road users and additional costs to the public and the road authority responsible for the traffic signals.
- 2 This chapter provides an overview only of aspects related to the *management* of traffic signal maintenance. Technical procedures and methods of maintaining traffic signals are not discussed – such information can be obtained from the manufacturers of signal equipment. Some information in this regard can also be obtained from the references given in the bibliography.
- 3 The chapter is further restricted to the management of traffic signal components only, and does not cover other work such as the road pavement, road markings, road signs, etc. Remedying defects that occur during the contractual defects liability period and which are covered under the implementation contract, is also not covered in this chapter.

### 28.2 CONSEQUENCES OF MAINTENANCE DEFICIENCIES

- 1 The cost-effectiveness of good signal maintenance is beyond question. The traffic safety implications of malfunctioning traffic signals alone can justify the cost of keeping signals in proper working order.
- 2 The possibility of liability judgements against a road authority is also an important consideration in signal maintenance. Proper maintenance of traffic signals is of vital importance if liability is to be minimised.
- 3 It is particularly important that appropriate maintenance procedures should be in place AND strictly adhered to by personnel. These maintenance procedures must demonstrate a thoroughness, and must reflect a duty to care and to report defects. The maintenance procedure can be used as evidence regarding the standard of care taken by the road authority concerned.
- 4 It is also particularly important that proper maintenance records be kept so that in the event of litigation there will be no doubt, as to the nature and extent of the maintenance actions taken, and when such actions were taken. Many litigation actions would tend to shift the blame for an accident onto some aspect of the traffic signal.

### 28.3 REDUCING MAINTENANCE REQUIREMENTS

- 1 The maintenance of traffic signals can require a significant expenditure on manpower and material. An effort should therefore be made during the design and installation stages to implement systems that would contribute to minimising maintenance costs.
- 2 The following are a number of the factors that can contribute to high maintenance costs:
  - (a) Inappropriate selection of technology and highly sophisticated systems without due consideration of available skills and maintenance funds.

- (b) Inadequate inspection during installation is often an important reason for maintenance problems. Some deficiencies are of such a nature that they cannot be detected, even with proper inspection. It is therefore important that responsible and experienced persons should undertake signal installations.
  - (c) The use of poor quality or non-standard equipment will require more skills and greater inventories of spare parts. Different types of equipment may require different maintenance procedures, which increase the management effort.
  - (d) Not providing adequately for maintenance in the design of traffic signal components.
- 3 An important factor in the design of signals is the provision for resistance against damage due to power surges, such as those resulting from lightning. Power surges can result in the destruction of all electronic components at a traffic signal, which will then have to be replaced at high cost.

### 28.4 TYPES OF MAINTENANCE

- 1 Maintenance falls into two broad categories: **routine** and **repair** maintenance. The term "maintenance" is generally taken to mean both these operations.
- 2 Routine maintenance consists of a periodic inspection and servicing of traffic signals.
- 3 Repair maintenance is undertaken in direct response to reported failures at traffic signals.

### 28.5 ROUTINE MAINTENANCE

#### 28.5.1 General

- 1 Routine maintenance should primarily be aimed at those components where pro-active intervention is required. It is not cost-effective to service all signal components regularly while they are still in operating condition. It is more important that attention should be given during routine maintenance to the identification of signal components that are faulty.
- 2 Routine maintenance actions would normally include those recommended by the manufacturer of the traffic signal equipment. Different manufacturers may have diverse maintenance requirements for their equipment. Information on these requirements must be obtained from the manufacturer.
- 3 Other routine maintenance actions are summarised in Table 28.1. The actions listed in the table are discussed in following subsections.
- 4 The intervals at which routine maintenance actions are undertaken depend on a variety of factors, such as the availability of a remote monitoring system. One possible method is to implement a regular inspection system and to undertake routine maintenance only when required.

### 28.5.2 Routine controller cabinet maintenance

- 1 The maintenance of the controller cabinet involves checking of the cabinet door for proper operation and ensuring that the cabinet is not damaged or dirty. Weatherproof seals must be in a good condition to prevent moisture entering the cabinet. The cabinet must be kept clean, and particular attention must be given to possible insect infestations.
- 2 Infestations by insects, especially ants, and other pests can be a serious problem at traffic signal installations. Special insecticides should be used that do not damage the electrical and electronic components. Infestations are also indicative that the cabinet or enclosure is not adequately sealed against elements.

### 28.5.3 Routine signal head maintenance

- 1 The maintenance of signal heads includes activities such as lamp replacement, cleaning of lenses and reflectors, alignment of the signal heads and inspection for damage.
- 2 It is important that lenses should be fitted and sealed properly to prevent the ingress of moisture and dust. Ingress of moisture or excessive condensation within the signal head housing may cause oxidation of metal parts and problems with electrical connections and transformers for quartz-halogen lamps.

### 28.5.4 Routine signal post maintenance

- 1 Signal post maintenance covers aspects such as checking for accident and other damage as well as the repainting of the posts.
- 2 Posts can usually not be repaired when damaged in an accident, and are then replaced with new posts.

### 28.5.5 Routine push button maintenance

- 1 Push button maintenance is required to ensure that push buttons are operating properly and that they are not damaged.
- 2 The maintenance action may have to be extended to also include special devices provided for disabled pedestrians.

### 28.5.6 Routine detector loop maintenance

- 1 The vehicle detector loop is one of the more vulnerable components of a traffic signal system. They can be a frequent source of trouble if they not correctly installed. The normal movement of a flexible road pavement, together with the ingress of material into the loop slots, can cause abrasion with eventual breakdown of the insulation on the loop wires.
- 2 The reliability of detector loops can be significantly improved by following proper installation procedures. These procedures are described in Chapter 20 of this manual (Volume 3).

**TABLE 28.1: ROUTINE MAINTENANCE**

| Maintenance task  |
|---|
| <b>Controller cabinet (including pedestal)</b>                            |
| Door, hinges and locks  |
| Weatherproof seal (gasket)  |
| Damage, rust, dirt, insect infestation, etc.                              |
| <b>Signal heads (lenses, reflectors, visors, background screen, etc.)</b> |
| Clean signal heads (particularly lenses)                                  |
| Signal head alignment   |
| Damage to signal heads and lamps  |
| Damage includes broken lenses, faded colours                              |
| <b>Signal posts (including anchor bolts)</b>                              |
| Repainting of posts   |
| Damage and rust   |
| Post support and anchors  |
| <b>Other road signs</b>   |
| Damage and rust   |
| Anchoring of signs  |
| <b>Push buttons</b>   |
| Push button operation   |
| Damage and rust   |
| <b>Loop detectors</b>   |
| Visual inspection of loops  |
| Verify detector operation   |
| <b>Pull-boxes and manholes</b>  |
| Damage to covers and installations  |
| Excessive water, dirt, insect infestation                                 |
| <b>Cables and other electrical</b>  |
| Cable joints (those that are visible)                                     |
| Circuit breakers  |
| Earthing  |
| <b>Controllers</b>  |
| Electromechanical assemblies  |
| Relays, Flashers, Switches, Connectors                                    |
| Lamp and fault monitor  |
| Conflict monitor  |
| Communication devices   |
| Lightning protection unit (if testable)                                   |
| Backup batteries (if provided)  |
| Other as per manufacturer requirements                                    |

**28.5.7 Routine maintenance of draw boxes and manholes**

- 1 The maintenance of draw boxes and manholes involves checking them for damage and cleanliness. Checks should also be made for infestations by insects and other pests.
- 2 Theft of metal manhole covers may be a problem in certain areas. Consideration should then be given to using covers made of concrete or similar material.

**28.5.8 Routine maintenance of electrical cables and other electrical components**

- 1 Maintenance is required for all electronic components, including cables, cable connections, circuit breakers and earthing.
- 2 Cables can be vulnerable to damage during traffic accidents, and be a source of great danger when exposed. Maintenance efforts can be minimised if adequate provision is made for fail-safe designs or the easy replacement of cables.

**28.5.9 Routine controller maintenance**

- 1 The maintenance of a signal controller is a complex task and must be undertaken by skilled personnel. Routine maintenance may include tasks such as running diagnostic tests, replacing defective or damaged modules as well as printed circuit boards.
- 2 The advice and instructions of the manufacturer on maintenance and repair procedures, including testing and diagnostic procedures, should be closely followed. Where special tools or testing equipment are necessary, these should be made available to the maintenance and repair personnel and should be kept in good working condition.
- 3 Faults in electromechanical controllers can often readily be detected by visual inspection. Reasons for breakdowns include blown fuses, in-operative motors, contact points burnt or welded together, and camshaft lugs broken. Repair of electromechanical units is often relatively simple, provided spares are readily available.
- 4 Electronic controllers may be repaired by replacing defective circuit boards or modules. A controller will usually comprise several separate and independently replaceable boards or modules mounted on a motherboard or back plate.
- 5 Where a backup battery is provided in the controller, it is important that such battery be checked occasionally and replaced according to manufacturer's recommendations.
- 6 Where possible, lightning protection units should also be checked regularly and be replaced when defective.

**28.5.10 Routine maintenance of road signs and road markings**

- 1 The routine maintenance of road signs and markings provided at traffic signals is necessary when they are faded, damaged or not properly anchored to posts.
- 2 The maintenance of road signs and markings would usually not be undertaken by the signal maintenance team, and a separate team would normally be assigned for such work. It is, however, important that this team be informed of defects when they occur.

**28.6 REPAIR MAINTENANCE****28.6.1 Introduction**

- 1 Repair maintenance is aimed at repairing reported malfunctions in traffic signals. Such malfunctions occur due to reasons such as:
  - (a) Signal components reaching functional obsolescence.
  - (b) Poor construction techniques or substandard quality products.
  - (c) Traffic accidents, vandalism and natural causes, such as lightning, heavy winds, ingress of moisture, insects, etc.
  - (d) Environmental (dirt and dust).
- 2 Many malfunctions are caused by traffic accidents, but poor routine maintenance could also be contributing to a high incidence of signal faults.

**28.6.2 Fault detection**

- 1 Faults in signal operations can be detected in a number of ways. These include the following:
  - (a) Police reports of damage as a result of accidents.
  - (b) Complaints received from the public, the police or other departments of the road authority.
  - (c) Computer based detection of malfunctions.
  - (d) Routine inspections by a maintenance team.
- 2 Due to the high incidence of damage resulting from traffic accidents, standard procedures should be put in place according to which police can report such damage.
- 3 The public also plays an important role in reporting malfunctions. It is particularly important that an easy reporting procedure should be implemented which is widely publicised. A central fault reporting telephone number used for all types of municipal problems is a very effective method of allowing the public to report any faults.
- 4 The availability of a central computer (remote monitoring system) can simplify the detection of malfunctioning equipment significantly. A variety of diagnostic tests can be undertaken of the various electronic components in a signal system, and possible errors logged for further attention by a maintenance team.
- 5 The maintenance teams themselves can be utilised to undertake routine inspections when they are not attending to emergencies. These teams can undertake the routine repairs themselves, or work orders may be issued for more specialised repair work.

### 28.6.3 Response to malfunctions

- 1 Responding to a malfunction requires a formal system whereby a maintenance team can be instructed to undertake the required repair work.
- 2 Certain malfunctions require a more urgent response than others. Malfunctions that pose a public danger should receive priority.
- 3 Emergency malfunctions are those that create an immediate danger to the public or traffic, and should be attended to immediately. A 24-hour standby service should be available to handle such malfunctions. The following are examples of malfunctions that should be considered as emergencies:
  - (a) Any malfunction causing all red signal aspects failing on one or more approaches at a signalised junction.
  - (b) Displaced signal aspects resulting in the display of green signals to conflicting traffic streams.
  - (c) Signal posts and other components creating a hazard on the roadway.
  - (d) Exposed electrical cables that could result in life-threatening situations or in short-circuits.
  - (e) Opened or damaged controller cabinets resulting in exposed electronic or electrical components.
- 4 Other malfunctions that do not create immediate dangerous situations do not have to be treated as emergencies, and can be attended to at a more opportune time. Priority should, however, be given to those malfunctions that have the most disruptive effect on traffic flow, or which result in the highest levels of congestion.
- 5 The following response times, between the time that the maintenance team was informed of a malfunction and the time of arrival of the team at the site, are generally recommended:
  - (a) Emergency malfunctions that may have safety implications – The response time should not exceed two hours for 24 hours of the day, seven days of the week. Maintenance work undertaken in response to these malfunctions can be restricted to emergency repairs only.
  - (b) Major malfunctions that could seriously effect traffic flow, but not road safety – These types of malfunctions do not need immediate response, particularly if such malfunctions occur at night or over weekends. During weekdays, a response should be required on the same day if the malfunction is reported before 12:00. When reported after 12:00, or over the weekend or a public holiday, a response should be required before 12:00 on the next available workday.
  - (c) Minor malfunctions that would not seriously affect both traffic flow and road safety – A response time of longer than one day can be given, depending on the type of the malfunction.
- 6 Responding to malfunctions does not mean that a fault must be repaired immediately and at any cost. Maintenance work can be restricted to emergency repairs to make the signal safe, and the permanent repair work can be done at a more opportune time when manpower and materials are available for the work.

- 7 **A signal can be made safe by placing it in flashing mode, but where this is not possible the signals may be switched off. In cases where repair will take some time, consideration may be given to masking the signals out, and using temporary stop signs for the control of the junction or crossing.**

## 28.7 MAINTENANCE RECORDS

- 1 Detailed recording of fault reports and maintenance activities is an essential part of traffic signal maintenance. Such records are not only required for litigation purposes, but also form an important part of the management process. A file should be opened for each signal installation and record kept of each action taken at the installation.
- 2 An effective recording system is also essential where maintenance is contracted out and there are maximum time limits prescribed for action by the contractor, with commensurate penalties for failing to meet them.
- 3 Additional information on maintenance records is provided in Chapter 30 of this manual (Volume 3).

## 28.8 MAINTENANCE PERSONNEL

- 1 Required maintenance personnel levels and skills are discussed in Chapter 25 of this manual (Volume 3). A maintenance team should consist of qualified electricians, line workers and worker assistants.
- 2 Electricians are responsible for the maintenance of the electrical and electronic components of traffic signals. Line workers are responsible for tasks such as lamp replacement, cleaning of lenses, painting of posts and alignment of signals.
- 3 At least one emergency response team should always be on standby, 24 hours of the day, even if the team has limited capabilities. This team should be able to undertake emergency repairs.
- 4 **IMPORTANT NOTE:** All electrical work may only be carried out by a qualified electrician and under no circumstances should anyone else open a cabinet or enclosure containing electrical apparatus, live cables or exposed electrical terminals where there is a danger of electric shock.

## 28.9 MAINTENANCE RESOURCES

- 1 Adequate resources and spare parts should be available to allow maintenance personnel to undertake and complete maintenance work.
- 2 It is important that an administration facility be provided from where the maintenance activities can be managed and where malfunctions can be reported.
- 3 Teams should be provided with service vehicles equipped with all the required tools, spares and consumables required for the maintenance of traffic signals. Radios or cellular telephones should be provided for on-street communication. At least one truck must also be available that will allow personnel access to overhead signals.
- 4 Larger road authorities may also provide a workshop facility where signal components can be repaired. Smaller authorities would probably employ contractors for such maintenance duties.

### 28.10 CONTRACT MAINTENANCE

- 1 Traffic signal maintenance can readily be undertaken on a contractual basis. Smaller road authorities can probably not justify employing a full-time staff complement for maintaining signals. For larger road authorities, however, there could also be advantages in employing a contractor to undertake the signal maintenance.
- 2 Two types of contract maintenance can be considered. Firstly, the contract is between two separate road authorities with adjoining jurisdictions. Under this arrangement, the one road authority can maintain traffic signals on behalf of the other road authority. Payment for the service is usually a flat annual amount.
- 3 The second type of maintenance contract is with a private contractor. The contract should normally include only those tasks that are well defined, such as group replacement of signal lamps, painting of posts, etc. Where new installations are constructed by private contractors, a period of contract maintenance may be a part of the installation contract.
- 4 Provision should be made in the contract for two types of maintenance. The one type relates to routine inspections and maintenance, including the repair of defects other than those caused by damage. The other type will cover the repair of damage resulting from collision, explosion, earthquake, flood, riot and other incidents.
- 5 An essential element in any maintenance contract is the establishment of an effective system for recording the details of defects and damage as they are reported, and of subsequent repair work when it is completed. The records should clearly indicate the category of work, for payment purposes. Dates and times of these events should always be carefully recorded.
- 6 To ensure timely performance by the contractor, it is important to specify maximum time limits for the response to a reported malfunction, and for effecting repairs (see Section 28.6.3). If the contractor fails to meet a stipulated deadline for a single call-out, a penalty should be specified, usually in the form of a rebate to the road authority, per hour or other period by which he exceeds the time limit. The response times can be negotiated with contractors with the aim of reducing costs, as long as road safety is not compromised.

### 28.11 BIBLIOGRAPHY

- 1 Babamia, M. 1999, *Determination of strategies towards the optimum maintenance of the traffic signal system in Pretoria given specific funding levels*, University of Pretoria.
- 2 Institute of Transportation Engineers (ITE), 1989, *Traffic signal installation and maintenance manual*, Prentice-Hall, Englewood Cliffs, New Jersey.
- 3 Institute of Transportation Engineers (ITE), 1995, *Operation and maintenance of electronic traffic control systems*, Washington DC.
- 4 Parsonson, PS, 1979, *Management of traffic signal maintenance*, NCHRP Report 114, National Co-operative Highway Research Program, Transportation Research Board (TRB), Washington DC.
- 5 Kraft, WH, 1997, *Traffic Signal Control Systems Maintenance Management Practices*, Synthesis of Highway Practice 245, National Co-operative Highway Research Program, Transportation Research Board (TRB), Washington DC.



## CHAPTER 29: SIGNAL TIMING UPDATING

### 29.1 INTRODUCTION

- 1 The timing and phasing of traffic signals will inevitably become outdated due to changes in traffic demand or improvements to the road network. Traffic signal settings therefore need to be reviewed periodically to ensure that the traffic operations are optimal.
- 2 Methods for timing and phasing traffic signals are described in Chapter 5 of this manual (Volume 3). The purpose of this chapter is to discuss a management system that would ensure that traffic signals are updated when needed.

### 29.2 NEED FOR UPDATING

- 1 Traffic signal timings only need to be updated when changes have occurred. In situations where the road network is unchanged and traffic patterns do not vary much, regular updates are not required. The management system should therefore be orientated towards identifying those signals where changes have occurred since the previous timing update and establishing whether the signals require updating.
- 2 Generally, priority will be given to updating traffic signal timings when new traffic signals have been installed or where physical changes have been made to a junction:
  - (a) The installation of new traffic signals often affects traffic patterns in an area. This will require updating of traffic signal timings once the traffic patterns have been stabilised. At least one month should be allowed for traffic to stabilise.
  - (b) Traffic signal timings will have to be updated when the geometry of a junction has been improved or the allocation of lanes to turning movements has been changed. If such changes are likely to affect traffic patterns in the area, it would be preferable to allow at least one month for traffic to stabilise.
- 3 At other junctions, priority would be given to junctions that are operating at high levels of saturation AND where high levels of traffic growth are being experienced. Junctions are less in need for updating when they are operating at lower levels of saturation OR where traffic growth is low.

- 4 An indication of the required signal timing updating cycle is given in Table 29.1. According to this table, signal timings should be updated every 1 or 2 years when traffic growth rates are high or when the signals are operating at a high degree of saturation. When traffic growth rates are average or when traffic signals are not operating at a high degree of saturation, signal timings should be updated every 2 or 3 years. A 3 to 5 year updating cycle would be acceptable when traffic growth rates are low or when the signals are operating at lower degrees of saturation.
- 5 The signal updating cycles given in Table 29.1 are not precise and can be adjusted according to specific circumstances and the availability of funds.
- 6 The table also presupposes that there is information available on traffic growth rates and degrees of saturation at signals. Other approaches and other updating cycles may be required when such information is not available or cannot readily be estimated.

### 29.3 DATA REQUIREMENTS

- 1 A traffic signal timing update management system should be based on a properly structured information collection and record keeping system. This system should, at a minimum, provide for the following basic information requirements:
  - (a) Record keeping of the date on which a traffic signal was last updated, the traffic counts used for such an update and the maximum degree of saturation calculated for the signal.
  - (b) A procedure should be instituted within an authority whereby the traffic signal design division is informed i) of any changes to the road network and ii) any new developments that could affect traffic patterns in an area. In fact, the division should form part of all decision making processes related to road network improvements and new developments.
  - (c) Traffic information is also required whereby changes in traffic patterns and volumes can be identified or growth rates estimated.

**TABLE 29.1: SIGNAL TIMING UPDATING CYCLE (YEARS)**

| Traffic growth rates per annum |        | Degree of saturation |             |        |
|--------------------------------|--------|----------------------|-------------|--------|
|                                |        | < 0,60               | 0,60 - 0,80 | > 0,80 |
| Low                            | 0 - 3% | 3 - 5                | 3 - 5       | 2 - 3  |
| Average                        | 3 - 5% | 3 - 5                | 2 - 3       | 2 - 3  |
| High                           | 5 - 8% | 2 - 3                | 2 - 3       | 1 - 2  |
| Exceptionally high             | > 8%   | 2 - 3                | 1 - 2       | 1 - 2  |

- 2 The collection of traffic information is an important component of the signal timing updating management system. Such traffic information collection can be orientated towards the updating of signal timings only, but often it forms part of a broader traffic information system.
- 3 Once a signal has been identified for updating, the signal should first be inspected during peak hours and a visual check made to establish whether the changes cannot be made by slight timing adjustments (using fine tuning techniques), or whether a full update is required. If a full update is required, traffic counts will be required for the updating.
- 3 Coverage automatic traffic counts are taken over a period of seven *normal* days of the week. These counts are used to supplement counts obtained from permanent counting stations to establish typical weekly traffic patterns and traffic growth rates in an area. In a traffic signal timing updating management system, they would be used to assist with the identification of traffic signals that require updating.
- 4 It is not necessary to count traffic annually at all coverage stations. On roads with low growth rates, traffic can be recounted once every two or three years. On roads with a high traffic growth, counts may have to be taken annually. A shorter counting cycle would also be required on the higher classes of roads, while lower classes of roads can be recounted less often.

## 29.4 TRAFFIC COUNTING SYSTEMS

### 29.4.1 General

- 1 The cost of traffic counts can be relatively high, particularly when it is necessary to update a number of traffic signal plans operating on different days of the week. The system described below can reduce the cost of traffic counts while maintaining a relatively high quality of information. The system uses a combination of automatic and manual traffic counts. Automatic traffic counts are taken on road links while manual traffic counts are taken at junctions.
- 2 The automatic traffic counts are used to establish broader traffic patterns and for the identification of areas where traffic patterns have changed significantly. Traffic growth rates can also be established from the counts and used in the estimation of signal timing updating cycles. Manual counts are required for establishing the traffic signal settings.
- 3 An advantage of the automatic traffic counts is that the counts normally cover the seven days (and nights) of the week. It is thus possible to identify changes that may occur only during particular days of the week. For instance, traffic patterns may be changing on Saturdays due to the development of shopping centres, while patterns may remain constant for the rest of the week.
- 4 The seven-day counts can also be used to identify design periods for each traffic signal timing plan. Manual counts can then be limited only to these periods, thus reducing the cost of such counts.

### 29.4.2 Automatic traffic counts

- 1 Automatic traffic counts are undertaken on road links rather than at junctions. The counts are taken at either permanent or coverage counting stations.
- 2 At permanent automatic counting stations, traffic is counted for 365 days of a year. These long-term counts are used primarily for the estimation of expansion factors that is used for expanding short-term traffic counts to an Annual Average Daily Traffic (AADT). The counts can also be used for the identification of exceptional traffic patterns caused by incidents that disrupted traffic flow in an area. Only a few counting stations, however, are normally required for these purposes since additional information can also be obtained from coverage counting stations.

### 29.4.3 Manual traffic counts

- 1 The manual counting method is used for counting traffic at junctions. Although significant developments have occurred in the field of automatic traffic counts, turning movement counts cannot readily be counted automatically.
- 2 Manual counts can be taken by using simple tally sheets, or by means of tally counters. Traffic counts are collected in 15-minute intervals (or shorter) and recorded on count forms. The counts can further be processed manually by means of a computer spreadsheet program or specialised computer software.
- 3 The disadvantage of manual traffic counts is that they become costly when undertaken over extended periods of time. At signals where counts are required for a number of timing plans, counting periods should be carefully selected to reduce the extent of the counts. The counting periods are often selected based on traffic patterns obtained from automatic counting stations.
- 4 The following are a number of practical aspects that need to be considered when manual traffic counts are conducted:
  - (a) Traffic counts should not proceed on those days when exceptional events occur. One of the counting team members (preferably the supervisor) should be on the lookout for such events. Counts should be discontinued if such exceptional events occur.
  - (b) At heavily congested junctions, it may also be necessary to observe queue lengths with the purpose of adjusting the traffic counts to account for growth or decay in queue lengths.
  - (c) A system of quality control is essential. A supervisor should be available to undertake spot checks on a regular basis.
  - (d) Recording of traffic counts at the end of each interval requires a finite amount of time. During this time, vehicles entering a junction may not be counted.



- 5 The recording of traffic counts at the end of each interval may result in the under-reporting of traffic volumes. This is not a major problem when traffic volumes are low, but it could become an issue during peak hours. The problem can be addressed by employing more personnel. An alternative method is to provide for a short break of about one minute at the end of each 15 minute counting period for the recording of the counts (counts are then only taken over 14 minutes).

#### 29.4.4 Queue length adjustments

- 1 A traffic count is not always an indication of traffic demand. A low traffic volume could indicate congested conditions rather than a low demand. If this occurs, queues of vehicles at traffic signals should be observed and the traffic counts adjusted for changes in the queue lengths. These queues may be forming at the signal or signals being investigated or at other upstream bottlenecks in the system. In such cases, the traffic demand should be estimated at such bottlenecks and projected through the road network.
- 2 Queues at a bottleneck may rapidly build up during congested conditions. During saturated conditions, vehicles cannot move through the bottleneck during the 15-minute counting interval, resulting in a residual queue at the interval. The traffic count should therefore be adjusted accordingly.
- 3 The traffic demand can be estimated by observing this increase in the residual queue. For example, suppose the queue length at the start of a 15-minute interval is 25 vehicles, and this increases to 65 vehicles at the end of the interval. In such a case, the traffic demand is increased by the difference in the queue lengths, or by 40 vehicles in 15 minutes. This increase in demand should be projected through the entire signal network.
- 4 The converse is also true when a queue length decreases. If the queue length was 65 vehicles at the start of the interval and this reduces to 25 vehicles, the traffic demand is reduced by the difference, namely 40 vehicles.
- 5 When queue length adjustments are made at traffic signals, it is important that the queue length observations should be taken at one particular time in the signal cycle, preferably at the end of a green period. Queue lengths at signals can vary significantly over one cycle, and taking queue lengths at different times of the cycle could lead to the erroneous adjustment of traffic volumes.
- 6 The above adjustments would still probably under- or overestimate actual traffic demand due to traffic diverting to other routes in the network. Improvements of the road network and traffic signal settings may result in the traffic again redistributing throughout the network.

#### 29.4.5 Normal and exceptional days

- 1 The issue of normal and exceptional days is an important consideration when traffic is counted. Normal days occur most often during the year, and traffic volumes are more constant and show fewer fluctuations than traffic on exceptional days.
- 2 The possibility of large counting errors can be reduced if traffic is counted on normal days when the traffic flow is relatively stable, unaffected by events such as traffic accidents, road closure, construction and inclement weather, and during schools terms. Exceptional days include public and school holidays, as well as days on which traffic patterns are abnormal due to events such as traffic accidents, road closures, road construction, inclement weather, special sporting events, etc.
- 3 Exceptional days may be either unpredictable or predictable. The unpredictable days are days that cannot be predetermined and are typically caused by traffic accidents, construction and inclement weather. Predictable exceptional days are that can be predetermined and are known in advance, such as school and other holidays. Unpredictable exceptional days typically occur less often than predictable days.
- 4 Predictable exceptional days include public and school holidays, as well as other days which may be influenced by such holidays. A single public holiday in a week can affect traffic patterns during all the other days of the week, while a school holiday may affect traffic patterns for the full duration of the holiday as well as periods before and after the holiday.
- 5 It is more difficult to identify unpredictable exceptional days, with the result that counts taken on such days are probably the cause for some inappropriate traffic signal settings. It is therefore important that an effort should be made to establish whether an exceptional event occurs on the day traffic is being counted. If such an event occurs, the count is terminated and retaken on another day.
- 6 The following are examples of events that may result in exceptional traffic patterns:
  - (a) Road accidents at a junction, or at nearby junctions.
  - (b) Traffic signals out of order, either at the junction being counted or at a nearby junction.
  - (c) Rainfall that has a disruptive affect on traffic flow. Traffic flows are not likely to be affected when light rain occurs over a relatively short period of time, but flows can be affected during heavy thunderstorms.
  - (d) Road construction or the temporary closure of roads in the area.
  - (e) Special events, such as cultural, sport and political events.



## CHAPTER 30: TRAFFIC SIGNAL RECORDS

### 30.1 INTRODUCTION

- 1 An essential component of any management system is its inventory of assets and the keeping of various types of records. Such information should be kept in a well-organised record system.
- 2 A variety of traffic signal records may be kept, depending on the purpose for which the records are required. The following are the minimum that should be kept by a road authority:
  - (a) Installation records.
  - (b) Fault log and advice records.
  - (c) Maintenance records.
  - (d) Controller logs.More details of the above records are given in the following sections.
- 3 The traffic signal record keeping system can be either operated manually or it can be computerised (or both). Computerised record systems have the advantage that they can also be used for purposes such as the automatic scheduling of routine work and maintenance and the provision of statistics on a variety of aspects (such as the number of signals, maintenance response and repair times, etc). It is important that computerised systems be kept up to date and regularly backed up.

### 30.2 INSTALLATION RECORDS

- 1 According to the National Road Traffic Regulations, a record SHALL be kept for each traffic signal containing at least the following installation information:
  - (a) Scaled drawing of the layout of the junction or crossing, indicating lane markings and road layout.
  - (b) Number, type and location of traffic signal faces
  - (c) Number, type and location of pedestrian and pedal cyclist facilities, including pedestrian push buttons.
  - (d) Phasing, time plans and offset settings.
  - (e) Date of implementation.
  - (f) Name and registration number of the engineer or technologist (engineering) who approved the signal, and date of signature.
- 2 The above record should be that of the signal installation as it currently exists. Where a traffic signal installation has been modified or changed, a completely new record should be issued, and the older record archived for future reference.

- 3 Care should be taken to ensure that the installation record is a true reflection of the actual current traffic signal installation. It is relatively simple to check physical components of the installation, but it is more difficult to check traffic signal timings. It is therefore recommended that a record be kept of some unique code generated by computer software when timing plans are downloaded to a controller. Such a code could be a version number generated, or a checksum calculated by the computer.

### 30.3 FAULT LOG AND ADVICE RECORDS

- 1 *Fault log and advice records* contain information on all reported faults as well as the action taken in response to such reports.
- 2 Records should be kept of all faults and malfunctions reported by any person, including the public and the police. Records should also be kept of all faults reported by a remote monitoring system, if such a system is available.
- 3 The information recorded may contain the following:
  - (a) Dates and times of fault report and advice.
  - (b) Name of person handling fault report.
  - (c) Source of information.
  - (d) Location of the fault.
  - (e) Apparent nature of the fault.
  - (f) Description of action taken, including name of person requested to attend to fault.
  - (g) If police were contacted, the name, rank and number of the police officer.

### 30.4 MAINTENANCE RECORDS

- 1 A record should be kept of all maintenance and repair work undertaken by the road authority or a contractor. A maintenance record should be created for each separate signal installation.
- 2 The following information should be recorded in the maintenance records:
  - (a) Junction or crossing description and number.
  - (b) Date and time of repair.
  - (c) Maintenance team identification.
  - (d) Nature of fault or malfunction.
  - (e) Repairs and maintenance undertaken.
  - (f) Details of further work required.

### 30.5 CONTROLLER LOGS

- 1 Controller logs are kept in controller cabinets as a running record of all routine inspections, repair work, modifications as well as changes to the signal timing and phasing.
- 2 Provision should be made for the entry of the following information in the controller logs:
  - (a) Junction or crossing description and number.
  - (b) Date and time.
  - (c) Name and initials of person undertaking maintenance.
  - (d) Brief description of the modification or work undertaken.
  - (e) An indication if the work is complete or whether further action is needed.
- 3 Where signal timing plans are not downloaded from a central control system, a separate log should be kept of the dates and times timing plans were changed on a controller. The log should contain a version number (or checksum) of the latest timing plan installed on the controller. This log is particularly important where different maintenance personnel have access to the controller, and there is a possibility that an older timing plan may inadvertently be reinstalled.

### 30.6 ARCHIVING OF RECORDS

- 1 The responsible road authority should keep the current installation record of each traffic signal for as long as the traffic signal is in operation.
- 2 All other records described above, including older installation records that have been superseded by a new installation record, should be archived for a period of at least **5 years**.
- 3 When a traffic signal is removed, all records pertaining to the traffic signal should also be archived for a period of at least **5 years** after removal.

### 30.7 REFERENCING SYSTEMS

- 1 Traffic signal records require a relatively simple referencing system. A simple junction or pedestrian crossing number would normally be adequate for this purpose.
- 2 One method for numbering junctions or pedestrian crossings (nodes) is to subdivide an area into smaller zones. These zones could simply be the individual pages of a map book, or it could be the suburbs of a large city. Each zone is given an alphanumeric number, normally consisting of two or three letters. Each street in a zone is also numbered, also using a two or three letter alphanumeric code.
- 3 The junction number is determined as a combination of the zone number and two street numbers. Pedestrian crossings are numbered as a combination of the zone number and one street number, followed by a sequence number (to allow for the possibility of more than one crossing on the street).

## CHAPTER 31: CONTRACTS

### 31.1 INTRODUCTION

- 1 Road authorities may elect to outsource the design, installation and maintenance of traffic signals. The extent and nature of the projects can vary significantly, and may range from the installation of a single traffic signal to that of an advanced central control system.
- 2 Regardless of the scope of the projects, there are features common to all. The outstanding feature is that a contract between the road authority and a consultant or contractor is brought into being. A further feature is that the road authority is finally responsible for the provision and operation of a safe and efficient traffic signal system.

### 31.2 CONTENT OF CONTRACT DOCUMENTS

- 1 The intent behind the drafting of any contract is that there should be a clear, unambiguous and shared understanding between the contracting parties of items such as the following:
  - (a) The exact extent of the work to be undertaken in terms of the contract (with extent implying both a quantity and quality of specified activities).
  - (b) The responsibility of the contracting parties to each other.
  - (c) The time frame within which the work is to be completed.
  - (d) The total cost of the work.
- 2 It is often said that a contract document is not necessary until relations between the contracting parties become soured. To allow for this eventuality, contracts should always include clauses defining what constitutes disputes and the methods to be employed in their resolution.
- 3 Contracts also include clauses setting out the grounds and methods for termination of the contract. The preferred termination is simply that the work has been completed and paid for to the satisfaction of both parties. It is also possible that non-performance by either of the parties may force a premature termination as the only option.

### 31.3 STRUCTURE OF CONTRACT DOCUMENTS

- 1 An important principle in drawing up contract documents is the need for standardisation. Insistence on unique contract documents for each project will require contractors to study each tender document in detail prior to calculating and submitting a bid. Bid submissions are usually made under tight time constraints and contractors will price accordingly, usually with a margin of safety to allow for contingencies they may have been overlooked. Insistence on unique documents will thus carry an implicit cost penalty. A further penalty involves the fact that the continuous development and updating of any document, whether by the road authority or some other body can be a costly exercise. Furthermore, unique documents can inadvertently contain loopholes that can result in problems.

- 2 Standardisation of documents will allow for improvement over time by introducing amendments making individual clauses more readily understandable, and simultaneously removing loopholes that have presented themselves. Many bodies, such as SAICE and FIDIC, have developed standard documents that are a solid basis for any contract. It is also possible to refer to other documents such as the SABS standard specifications, Acts of Parliament, Provincial Ordinances and local by-laws. It is not necessary to repeat the content of these documents in the contract documents, and references to them would be adequate.
- 3 The contract documents should include the following:
  - (a) General Conditions of Contract, which spell out the typical relationship between client and contractor.
  - (b) Standard specifications being descriptions of the work to be done and that do not vary from project to project.
  - (c) Project specifications describing the specific project.
  - (d) A list of quantities, which may either be a Bill of Quantities or a Schedule.
  - (e) Drawings, which may include standard drawings.
- 4 In order to tailor the standard documentation to a specific project, it may be necessary to include the following in the contract:
  - (a) Special Conditions, which take precedence over the General Conditions and further define the contractual obligations of the two parties; and
  - (b) Special Provisions, which modify the Standard Specifications.
- 5 Contract documentation typically requires that the contractor provides performance guarantees in the form of insurance policies. In the event of non-performance by the contractor, it may be possible to recover losses sustained as a result of this non-performance.
- 6 A Tender Bid becomes a Contract on signature by both parties of a Letter of Agreement. The contract documentation normally includes a pro-forma Letter of Agreement for the information of the tenderer.
- 7 Tenders can be fixed price or allow for escalation, the latter being more equitable in times of high inflation or where the project may span over more than one year. In this case, the basis on which escalation of the contract price is calculated is defined in the contract documentation.
- 8 For a variety of reasons, it seldom happens that a project is built exactly as detailed in the original drawings. As the work progresses, it will be necessary to issue instructions or revised drawings (referred to as Variation Orders) to the contractor. These typically are grounds for the contractor to revise a price quoted for an item or to quote a new price for the work. Once agreed to by both parties, Variation Orders are signed by both and thereafter become part of the Contract Documentation.

- 9 Very often, a Dayworks Schedule is also included to allow for abnormal circumstances not necessarily forming part of the contract but where it is convenient to have these additional activities undertaken by the contractor. The Dayworks Schedule is, however, not considered as part of the contract for adjudication purposes.
- 10 Because of the issue of Variation Orders, it is necessary at completion of the project for "As Built" drawings to be submitted to the client. In the event of any subsequent dispute, reference is made to the "As Built" and not to the original design drawings.
- 11 Many contracts also provide for a period of maintenance, usually with a duration of twelve months, to ensure that there are no latent defects in the work as delivered. Any defects revealed during this maintenance period are repaired by the contractor at his own expense.

### 31.4 TENDER PROCESS

- 1 The client issues a Call for Tenders by advertising it in gazettes as well as newspapers. This advertisement typically includes:
  - (a) The name of the client.
  - (b) The number and name of the project being tendered for.
  - (c) A brief description of its content.
  - (d) The closing date for submission of bids.
  - (e) The source from which tender documents can be obtained, including reference to any payment that must be made for these documents, specifying whether this is a refundable deposit or not.
- 2 The tender documents are, in fact, the contract documents and include a list of quantities against which the tenderer can quote rates for each item billed.
- 3 If the client considers a Tenderers' Site Visit desirable, details of the date and venue will be included in the Call for Tenders. The Site Visit may be compulsory, in which case the client will issue Certificates of Attendance to tenderers. These should then be bound into the submitted bids. Failure to return a certificate could be deemed adequate grounds for rejection of the associated bid.
- 4 At the Site Visit, the client will describe the full extent of the works and draw attention to any points of particular concern as well as clarifying any uncertainties that would-be tenderers may have.
- 5 Tender submissions can take many forms. One method that can be followed consists of first requesting the tenderer to submit information illustrating an ability to undertake the intended project. This can be followed by a request for a technical proposal, which in turn may be followed by a request for the final bid.
- 6 A second method is the two-envelope process in which a tenderer submits a technical proposal (as well as information on the ability of the tenderer to undertake the intended project) in one envelope and a bid in the other envelope. Tenderers are then first adjudicated on the submitted technical proposals, followed by a second round of adjudication based on submitted bids.

- 7 The two-envelope method has fallen into disfavour because, particularly on large projects, pricing a tender is usually not a trivial task and pricing strategies can, in fact, be quite complex. It is considered inequitable to require a tenderer to devote significant amounts of time and money to deriving a bid when, in the opinion of the client, he or she is not competent to undertake the project. On relatively small and straightforward projects, it does however have the advantage of shortening the time span between advertisement and award of contract.

### 31.5 PROCUREMENT

- 1 A somewhat different form of contract involves the procurement of supplies outside the scope of normal design, construction and maintenance contracts. It would be patently ridiculous for an authority to have to call for tenders every time a light bulb had to be replaced. As a public body, the road authority must, however, be able to account for all funds disbursed.
- 2 In effect, procurement contracts amount to the creation of a panel of preferred suppliers for specified products with prices agreed to for a finite period, usually one year in duration.
- 3 Apart from the benefit of the creation of a system whereby public accountability is subject to audit, a properly structured procurement contract relieves the client of the necessity for maintaining a large stores department carrying a variety of capital and consumable items.

### 31.6 SERVICE LEVEL AGREEMENTS

- 1 Service Level Agreements are another specialised form of contract. They are brought into play when a road authority elects to outsource one or other of the activities that would normally be carried out in-house. A case in point would be the maintenance of all its traffic signalisation equipment.
- 2 All the normal conditions of the contract previously described apply equally to the Service Level Agreement. What is additionally specified, is the extent and quality of service required. For example, the maximum acceptable time elapsed between a request for service and arrival on site would be defined in the agreement.

### 31.7 BIBLIOGRAPHY

- 1 SAICE, 1982, General Conditions of Contract, South African Institution of Civil Engineering, Johannesburg.
- 2 FIDIC, 1987, Conditions of contract for electrical and mechanical works including erection on site, with Forms of Tender and Agreement, International Federation of Consulting Engineers, Lausanne.

## CHAPTER 32: ANNUAL REPORTS

### 32.1 INTRODUCTION

- 1 The annual report is an important function of a traffic signal division. The purpose of the annual report is to provide information on the work of the division and to indicate that the work was undertaken responsibly and in the best interest of the community and the road user.
- 2 Performance management and the assessment of key performance indices are mechanisms to ensure that the goals and objectives of providing traffic signals are achieved. The annual report should provide information on the degree to which these goals and objectives have been reached.

### 32.2 CONTENTS OF THE ANNUAL REPORT

#### 32.2.1 General

- 1 The annual report should provide information on aspects such as the following:
  - (a) Institutional.
  - (b) Special projects.
  - (c) Routine projects.
  - (d) Training and technology transfer.
  - (e) Programme and budget.
  - (f) Statistics.
- 2 Throughout the report there should be an emphasis on achievements and the degree to which key performance indices have been achieved.

#### 32.2.2 Institutional

- 1 The annual report should contain information on the institutional and organisational structure as well as staff composition of the traffic signal division. Staff shortages and vacancies should also be indicated.
- 2 The facilities available in the traffic division should also be described, together with an indication of the traffic control system in use.
- 3 Information should also be given on the utilisation of consulting engineers and contractors, as well as the projects on which they were utilised.
- 4 Details should also be provided on co-operation with other authorities as well as duties undertaken on behalf of such authorities.

#### 32.2.3 Special projects

- 1 The annual report should provide short summaries of special projects that have been undertaken by the traffic signal division.
- 2 Special projects would, for example, include upgrading to a new traffic signal system, installation of an operations control centre, installation of new traffic signals, etc. A special project is one that is not routinely undertaken each year.

#### 32.2.4 Routine projects

- 1 Routine projects are those routinely undertaken each year. These include the upgrading of traffic signal settings, maintenance activities, etc.
- 2 A short description should be given in the report of all the routine activities of the signal division.

#### 32.2.5 Training and technology transfer

- 1 The development of skills and knowledge in the traffic signal division is of such importance that it warrants a special section in the annual report. The signal division should be proud of any efforts made to provide training and to provide opportunities to personnel to improve their knowledge of traffic signalisation.
- 2 The report should highlight the importance of continued skill development and may refer to this manual to indicate the responsibility of road authorities to institute specific programmes at improving skills and knowledge.

#### 32.2.6 Programme and budget

- 1 One of the essential elements of the report is the work programme and budget of the traffic signal division, for the current year as well as the future year.
- 2 Proper account must be given of all work and expenses undertaken by the traffic signal division. Any new proposed projects should be well motivated and their benefits to the community and the road user explained.

#### 32.2.7 Statistics

- 1 Detailed statistics should be given in the report on all the activities of the traffic signal division. These statistics must cover the work of all personnel as well as consulting engineers and contractors.
- 2 Statistics should be given on aspects such as the following:
  - (a) Staff levels, subdivided according to function and qualifications.
  - (b) Traffic signal installations and other facilities.
  - (c) New traffic signal installations.
  - (d) Upgraded traffic signal installations.
  - (e) Traffic studies and accident statistics.
  - (f) Maintenance activities.
  - (g) Reported malfunctions, subdivided into classes of malfunctions.





# **SOUTH AFRICAN ROAD TRAFFIC SIGNS MANUAL**

## **VOLUME 3: TRAFFIC SIGNAL DESIGN**

**DIGITISED VERSION – May 2012**

### **APPENDICES**

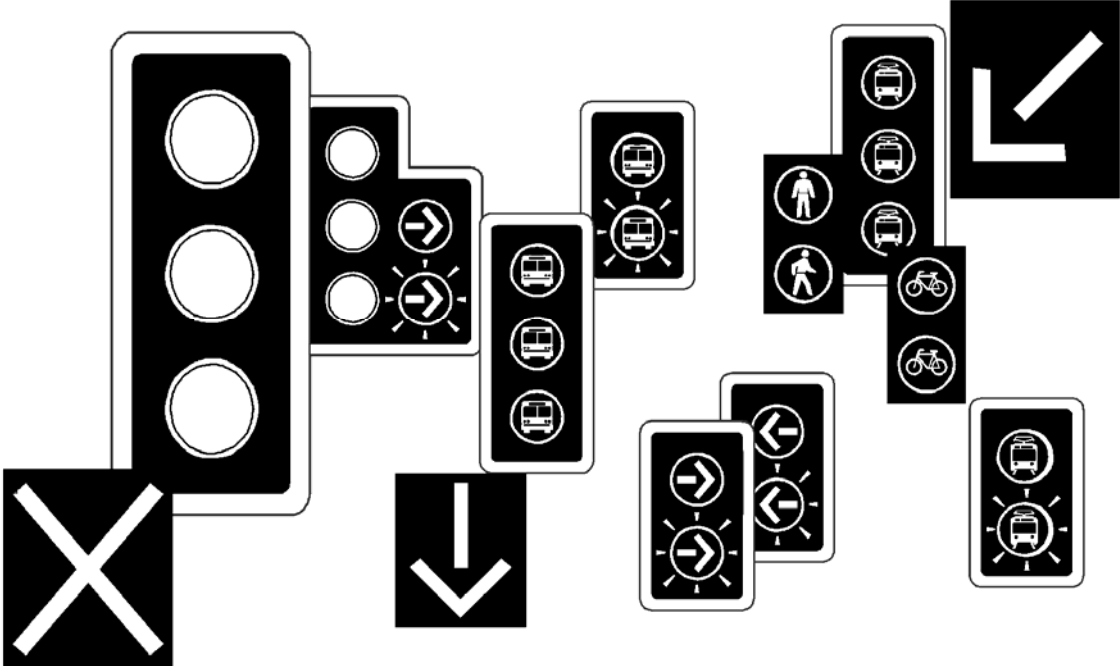



## APPENDIX A: GLOSSARY OF TERMS

### A.1 INTRODUCTION

- 1 This glossary of terms provides the terminology, abbreviations, and expressions used in traffic signal control. It includes terminology from the fields of traffic, electrical and electronic engineering which the practising traffic signal designer may come across from time to time.
- 2 The term defined is given in bold at the head of each definition. Where necessary, optional alternative terms and abbreviations are also given.

### A.2 GLOSSARY OF TERMS

- 1 **actuation** – The operation of a detector in registering the presence or passage of a vehicle or pedestrian.
- 2 **all-red (interval)** A condition (part of the cycle) when red light signals are displayed simultaneously to conflicting movements.
- 3 **amber light signal/interval** See yellow light signal/interval.
- 4 **area traffic control/ATC** The co-ordination of a number of signals in a road network by means of a central controller.
- 5 **aspect** A single lamp unit of a traffic signal which is one of the prescribed colours and which is capable of being internally illuminated. An illuminated aspect is called a *light signal*.
- 6 **bus light signal** A light signal for the control of minibuses and buses in a reserved bus lane.
- 7 **cabinet** An outdoor enclosure for housing the controller and associated equipment.
- 8 **cabless linking** A method of coordinating signals without use of a cable.
- 9 **call** See demand.
- 10 **cantilever** A supporting beam (for a signal light) fixed at one end only to a vertical post, similar to an inverted "L".
- 11 **capacity** In terms of traffic, the maximum number of vehicles that can pass across the stop line of an approach road to a signal, or a traffic lane, or make a particular movement (e.g. right turn capacity) in a given time period, expressed as vehicles or passenger car units per hour (veh/h or pcu/h).
- 12 **checksum** A check using the arithmetic sum of binary coded information.
- 13 **clearance interval** Any interval needed or provided to allow any traffic stream that has its right of way terminated to clear the conflict zone before a conflicting traffic stream gains right of way.
- 14 **command message** In a computerised traffic control system, a message sent from the control centre to the controller, via the communications system, giving the controller and connected devices an instruction or providing data.
- 15 **conflict monitor** A device, being part of a controller, that continually checks for the presence of conflicting signal light signals and that provides an output to the controller in response to its detecting a conflict condition, thus enabling the controller to respond accordingly, usually by switching immediately to flashing mode.
- 16 **control centre (instation)** The central control system and the place where the system is located.
- 17 **controller** An apparatus for controlling the operation of a traffic signal.
- 18 **co-ordination** The synchronous operation of two or more traffic signals to facilitate progressive movement of vehicles by means of a continuous green band.
- 19 **cycle length** The time taken to complete a full cycle of light signals.
- 20 **cycle** One complete sequence of traffic light signals for a given signal timing plan.
- 21 **degree of saturation** The traffic demand volume as a proportion of the capacity of a particular turning movement, during a particular time of the day.
- 22 **demand** A request for right of way by traffic as registered by a vehicle detector, pedestrian push button or control centre.
- 23 **demand-dependent phase** A phase which is provided upon a demand being registered through a vehicle detector or pedestrian push button.
- 24 **detector** A device comprising a detector unit and a sensing device such as a detector loop or a pedestrian push button, that detects the passage or presence of vehicles or pedestrians, whereupon it generates an appropriate output signal.
- 25 **detector lead-in cable** The cable connecting a detector loop to the detector unit.
- 26 **detector loop** An inductive loop, embedded in or laid on the road surface, which is connected to a detector unit, for sensing the passage or presence of vehicles.
- 27 **detector unit** A device that receives or detects a signal from a sensing device in the road, upon the passage or presence of vehicles, and provides an output signal. In an inductive loop detector the detector unit generates an inductive field in the detector loop and senses changes in induction caused by the passage or presence of vehicles.
- 28 **early cut-off** See lagging turning phase.
- 29 **electromechanical controller** A controller which uses motors, relays, step switches etc. to control a signal.
- 30 **exclusive pedestrian phase** See scramble pedestrian phase.
- 31 **fault monitoring** A system used for the detection and reporting of controller and other faults in a traffic signal.
- 32 **filter green arrow** Use left-turn phase.
- 33 **fixed time control** A mode of signal operation in which the sequence and duration of stages and the cycle time are fixed for a given signal timing plan.

- 34 **fully-actuated control** A mode of vehicle-actuated control in which all stages are actuated.
- 35 **gap change** In vehicle-actuated control, the termination of right of way to a phase on account of the vehicle extension interval having timed out (due to a gap in the traffic stream).
- 36 **green band/wave** The appearance of green light signals in succession at signals along a route, allowing the progressive flow of vehicles through and between successive signals along the route.
- 37 **green split** The proportion of time allocated to a green light signal in a cycle, calculated as the green time divided by the cycle length.
- 38 **hurry call** A request from an external device to a controller that a change to a specific stage be given priority. Used to give preferential right of way to emergency service vehicles, transit vehicles etc.
- 39 **indication** Use light signal.
- 40 **inductive loop detector** A vehicle detector which functions by induction and comprising a detector loop and appropriate detector unit.
- 41 **instation** see control centre.
- 42 **intergreen** The interval provided between conflicting green light signals and comprising the yellow light signal followed by a clearance or all-red signal.
- 43 **intersection** Legally defined as the area contained in the prolongation of the lateral boundary lines of two or more public roads, open to vehicular traffic, that join one another at any angle, whether or not one such public road crosses the other. In traffic engineering terms also used for a junction with four approach legs.
- 44 **interstage** Part of the signal cycle between any two consecutive stages.
- 45 **interval** Any part of the cycle during which the light signals do not change. Also used, when qualified, to describe the period of time during which a given light signal is displayed, e.g. yellow interval.
- 46 **isolated control** The operation of a traffic signal that is not co-ordinated with any other signal(s).
- 47 **junction** Legally defined as that portion of an intersection contained within the prolongation of the lateral limits of the intersecting roadways and include any portion of the roadway between such lateral limits, and any stop or yield line marking which is painted at such intersection. In traffic engineering terms used only for junctions with three approach legs (T-junctions).
- 48 **lagging turn phase** A turning phase that is provided after, or with, the termination of the main signal phase.
- 49 **lamp fault monitoring unit** A device that monitors the electrical characteristics of a signal circuit and detects signal lamp failures.
- 50 **latching** A feature of a controller that permits the registration of a detector demand to be retained - even if the detector output is not sustained - until cancelled internally by the controller e.g. upon the associated demand dependent phase green appearing.
- 51 **late release** See leading turning phase.
- 52 **leading turn phase** A turning phase that is provided before, or with, the start of the main signal phase.
- 53 **left-turn phase** A phase permitting traffic to turn left while conflicting traffic receives red light signals.
- 54 **level of service** Level of service is a measure of how effectively traffic demand is met by the available supply.
- 55 **light signal** A single illuminated aspect that has a particular meaning depending upon its colour, symbol (if any) and whether it is a steady or flashing signal. Examples include the red light signal, flashing green arrow light signal and a pedestrian red man light signal.
- 56 **locking** See latching.
- 57 **main signal phase** The main phase for an approach gives right of way to the main traffic stream(s), normally the straight-through traffic stream.
- 58 **major street** The roadway at a junction that normally carries the major volume of vehicular traffic.
- 59 **manual control** A mode of signal control where the controller is advanced manually to another condition or stage by the activation of a switch on a special manual control panel or police panel. See stage advance.
- 60 **master controller** A controller that co-ordinates the operation and synchronises signal timing plan changes in a number of (slave) controllers.
- 61 **maximum green (interval)** In vehicle-actuated control, the maximum time (the interval) that a given phase green is permitted to run.
- 62 **microprocessor** An integrated circuit that executes logical and arithmetical processes.
- 63 **microprocessor controllers** use integrated electronic circuits and solid state lamp signals for the control of a signal.
- 64 **minimum green (interval)** The shortest time a phase green will always run, irrespective of traffic conditions or external influences.
- 65 **minor street** The roadway at a junction that normally carries the minor volume of vehicular traffic.
- 66 **mode of control** The manner in which a controller operates, such as fixed time, co-ordinated fixed time, fully-actuated, semi-actuated, co-ordinated, manual, etc. A given controller may be able to operate in more than one mode, but it will operate under only one mode at any one time.
- 67 **non-latching** A feature of a controller whereby a detector demand registers only for as long as there is an output from the detector unit.
- 68 **non-locking** See non-latching.
- 69 **offset** In co-ordinated control, the difference in time between the start of a signal stage at one traffic signal to the start of a signal stage at another signal, or some common time base. Sometimes also measured to the end of a signal stage.

- 70 **parallel phases** Two or more non-conflicting phases that run together for part of the cycle.
- 71 **passage detection** A vehicle detection mode where the detector unit emits a single, short pulse signal at the instant a vehicle enters the detection loop. Sometimes called pulse detection.
- 72 **pedal cyclist light signal** A light signal for the control of pedal cyclists.
- 73 **pedestrian clearance time** The period of time needed for pedestrians to be able to clear the conflict zone before the onset of a conflicting vehicular signal.
- 74 **pedestrian crossing** Legally defined as a) any portion of a public road designated as a pedestrian crossing by appropriate road traffic signs or b) that portion of a public road at an intersection included within the prolongation or connection of the kerb line and adjacent boundary line of such road, when no pedestrian crossing has been designated by appropriate road traffic signs.
- 75 **pedestrian light signal** A light signal for the control of pedestrians.
- 76 **pedestrian phase** A phase for the control of pedestrian traffic.
- 77 **pedestrian push button** A push button device pressed by pedestrians to demand a pedestrian phase.
- 78 **permissive right turn** See permitted right turn.
- 79 **permitted right turn** A right turn that is made by the turning vehicle crossing through gaps in the opposing flow during the main phase.
- 80 **permitted-only right turn** A right turn movement that is permitted, but no exclusive turning signal phase is provided.
- 81 **phase** An interval of the signal cycle during which a particular green signal is displayed. The phase starts when the particular green signal is first displayed and ends as soon as this same green signal is terminated. Equivalent to a green signal.
- 82 **platoon dispersion diagram** A graphical representation of the dispersion of platoons of traffic on a distance-time diagram.
- 83 **police panel** A panel in a controller, for manual control/ a lockable, small, door giving access to the manual control panel.
- 84 **pre-emption** Use hurry call.
- 85 **presence detection** A vehicle detection mode where the detector unit emits a signal while the detection area (the loop of an inductive detector) is occupied by a vehicle.
- 86 **pre-timed control** See fixed time control.
- 87 **principal traffic signal faces** Signal faces provided to meet the minimum legal requirements.
- 88 **progression diagram** A graphical representation of the spatial disposition of signals and their timings relative to one another.
- 89 **progression** Of vehicular traffic, the uninterrupted or near uninterrupted flow of traffic through and between adjacent signals, as a result of co-ordination.
- 90 **prohibited turn** A turning movement that is not permitted.
- 91 **protected turn** A turn made by a vehicle during an exclusive turning phase, when conflicting traffic is stopped by a red light signal. Use turning phase.
- 92 **protected/permitted turn** A turn than can be made either as a protected or permitted turn.
- 93 **protected-only turn** A turn that can ONLY be made during a protected turning phase.
- 94 **remote monitoring systems (RMS)** Central control systems used for the remote monitoring of faults and the synchronisation of timing equipment at local traffic signal controllers.
- 95 **revert** In vehicle-actuated control, for the controller to automatically return to a pre-selected stage once conflicting stages have been serviced, and in the absence of any demands.
- 96 **right of way** The condition that applies when a green light signal is displayed to traffic, permitting it to proceed if the way is clear and subject to the rules of priority on the road with regard to turning vehicular traffic and pedestrians.
- 97 **right-turn phase** A phase for traffic turning right from an approach, where right of way is signalled by a flashing green right arrow light signal and traffic approaching from the opposite direction is stopped by a red light signal.
- 98 **saturation flow** The maximum rate at which vehicles are able to cross the stop line under the prevailing conditions at a signalised road junction or pedestrian crossing when a green light signal is displayed, assuming unending demand and no lost time.
- 99 **scramble pedestrian phase** One phase that includes all the pedestrian movements at a road junction simultaneously, to the exclusion of any vehicular phase.
- 100 **semi-actuated control** A mode of signal operation in which the appearance and duration of some, but not all, stages (usually those in which side-road phases appear) depend upon demands and extensions registered by vehicle detectors and pedestrian push button actuations.
- 101 **semi-actuated control** A mode of vehicle-actuated control in which only a subset of stages are actuated.
- 102 **serial pedestrian phase** See scramble pedestrian phase.
- 103 **signal group** A group of traffic signal faces that always display exactly the same sequence of light signals at the same time. These traffic signal faces are electrically interconnected and can therefore not display different signal times at any time.
- 104 **signal timing plan** The predetermined sequence of stages and their timings applicable to a particular mode of operation.
- 105 **slipway** A roadway that passes to the left (or in the instance of one-way systems, to the right) of the main junction without intersecting the main junction.
- 106 **solid-state electronic controllers** use relatively basic transistorised electronic circuitry to control a signal.
- 107 **space-time diagram** See progression diagram.

- 108 **stage** An interval of the signal cycle during which any combination of vehicular green signals is displayed (pedestrian or pedal cyclist green signals excluded). A stage starts when any vehicular green signal is first displayed and ends as soon as any of the vehicular green signals being displayed are terminated.
- 109 **starting lost time** The time lost during the start of a green phase due to reaction time and acceleration of vehicles.
- 110 **start-up sequence** The order of appearance of light signals, and their duration, when the controller and lamps are powered up.
- 111 **start-up stage** The stage that always follows the start-up sequence.
- 112 **supplementary traffic signal faces** Additional traffic signal faces, not being principal traffic signal faces, provided to meet requirements in respect of visibility and conspicuity or improved traffic operations.
- 113 **traffic adaptive control** A method of control whereby traffic signal timings are adjusted based real-time traffic demands registered at traffic detectors, and using a relatively simple model of traffic flows.
- 114 **traffic responsive control** A method of control whereby traffic signal timings are adjusted based real-time traffic demands registered at traffic detectors, and using a relatively complex model of traffic flows.
- 115 **traffic signal** A complete installation comprising a set of traffic lights, a controller and associated equipment for the control of traffic on all road approaches and on all pedestrian crossing points (if appropriate) at a particular site.
- 116 **traffic signal face** A single arrangement of signal aspects that is intended for warning and regulating traffic from one direction.
- 117 **traffic signal head** An assembly consisting of one or more traffic signal aspects together with the associated signal housing.
- 118 **traffic stream/movement** Traffic on one approach or crossing that moves in the same direction on having right of way.
- 119 **traffic** All road users, including vehicles, pedestrians and/or pedal cyclists.
- 120 **tram light signal** A light signal used for the control of trams.
- 121 **vehicle-actuated control** A mode of signal control in which the appearance and duration of stages depend upon demands and extensions registered by vehicle detectors and pedestrian push button actuations.
- 122 **vehicular light signal** A light signal dedicated to the control of vehicular traffic (as opposed to pedestrian traffic).
- 123 **yellow effective green** The portion of a yellow interval which is effectively used by traffic as green time.

## APPENDIX B: EXAMPLE TRAFFIC SIGNAL LAYOUTS

### B.1 EXAMPLE LAYOUTS

- 1 Minimum required principal traffic signal faces are shown for a variety of typical junctions in the diagrams given in this appendix. Principal signal faces are any faces provided to meet the minimum legal requirements of the National Road Traffic Regulations.
- 2 A number of additional supplementary traffic signal faces are also shown on some of the diagrams. A supplementary traffic signal face is any additional traffic signal face, not being a principal traffic signal face, provided to meet the requirements in respect of visibility and conspicuity or improved traffic operations.
- 3 The diagrams provided are schematic only, indicating the signal faces required for various junction and pedestrian crossing configurations. The symbols used in the diagrams are shown in the legend below.
- 4 The purpose of the diagrams is to show the required number and positions of traffic signal faces and NOT to indicate ideal junction layouts. In fact, some of the example layouts have been selected because they are not ideal. The intention is to indicate the position of signal faces even when junction layouts are not ideal.

### B.2 PEDESTRIAN SIGNALS

- 1 Pedestrian signals are also shown on most of the diagrams. Pedestrian signals will normally be provided where a significant number of pedestrians experience difficulty and/or delay in crossing a road at certain times during the day.
- 2 The pedestrian signals shown on the diagrams have been installed on posts where they are approximately in line with the pedestrian crossing, and where their view will not be obstructed by queued vehicles. The signal faces may, however, also be installed on the other posts shown in the drawings if their visibility at such posts will not be obstructed by such vehicles.

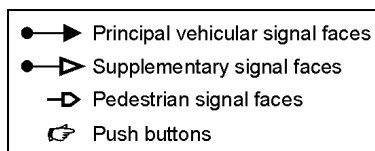

Legend of symbols used in layout diagrams

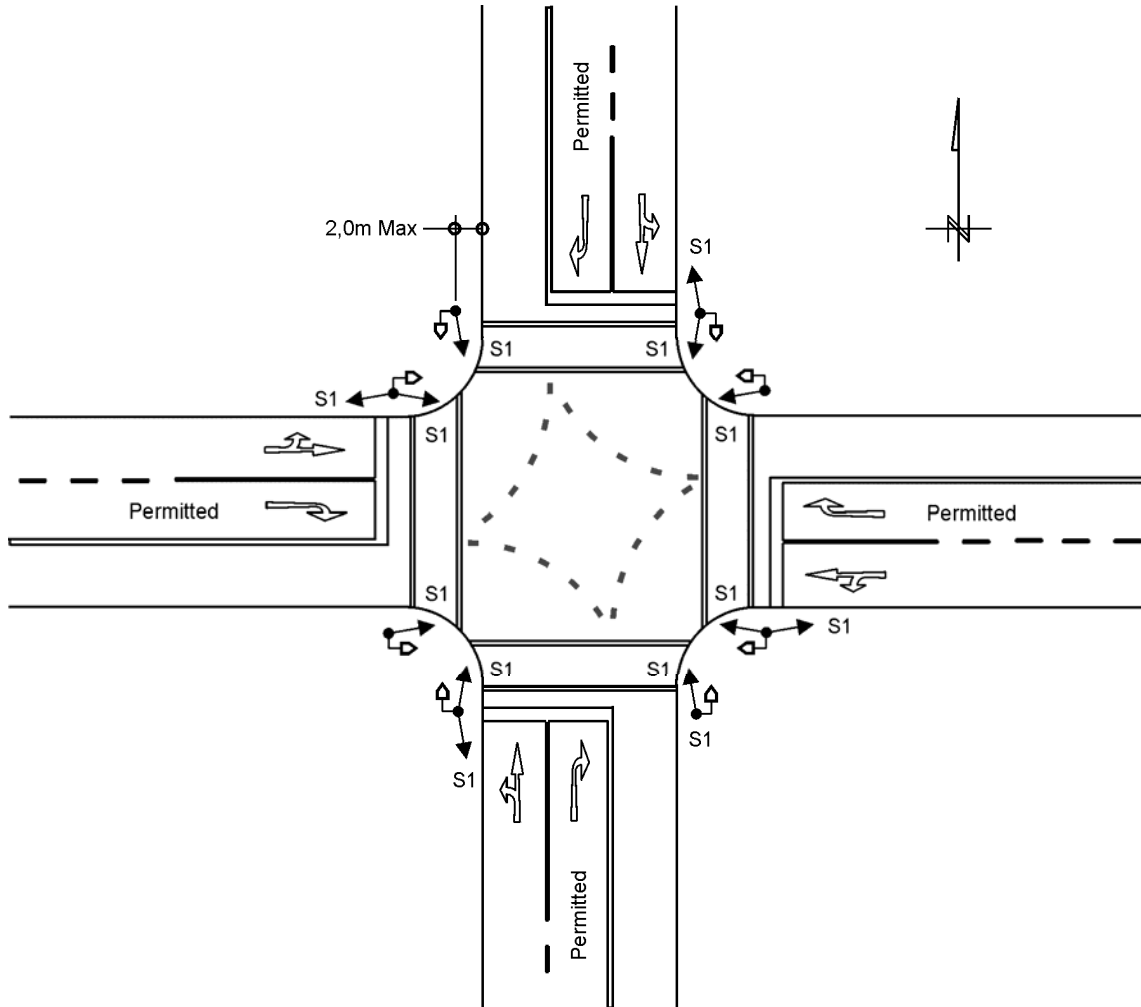

## NOTES

- 1 No protected right-turn phases are provided and S1 signal faces control all movements. Two principal S1 signal faces are provided on the far side and one principal S1 face on the near side of each approach.
- 2 None of the principal signal faces are further than 20 m apart (preferably 16 m), and no additional overhead faces are required on this account. Overhead faces, however, should be provided on high-speed approaches or when overhead signals have been provided at other junctions on the streets.
- 3 A minimum lateral clearance of 0,5 m should be provided from the kerb face or the edge of roadway and any post or part of a signal head, including the backboard. If there is a significant tipping of vehicles on the road, or where vehicles tend to cut corners, it is preferable to increase the clearance to 1,0 m or more.
- 4 The left-hand principal traffic signal face should generally be located not more than 2 m to the left of the continuation of the left-hand edge of the approach roadway, measured parallel to the road centre line.

**Diagram B.01: Example of a four-way junction with no right-turn phases**



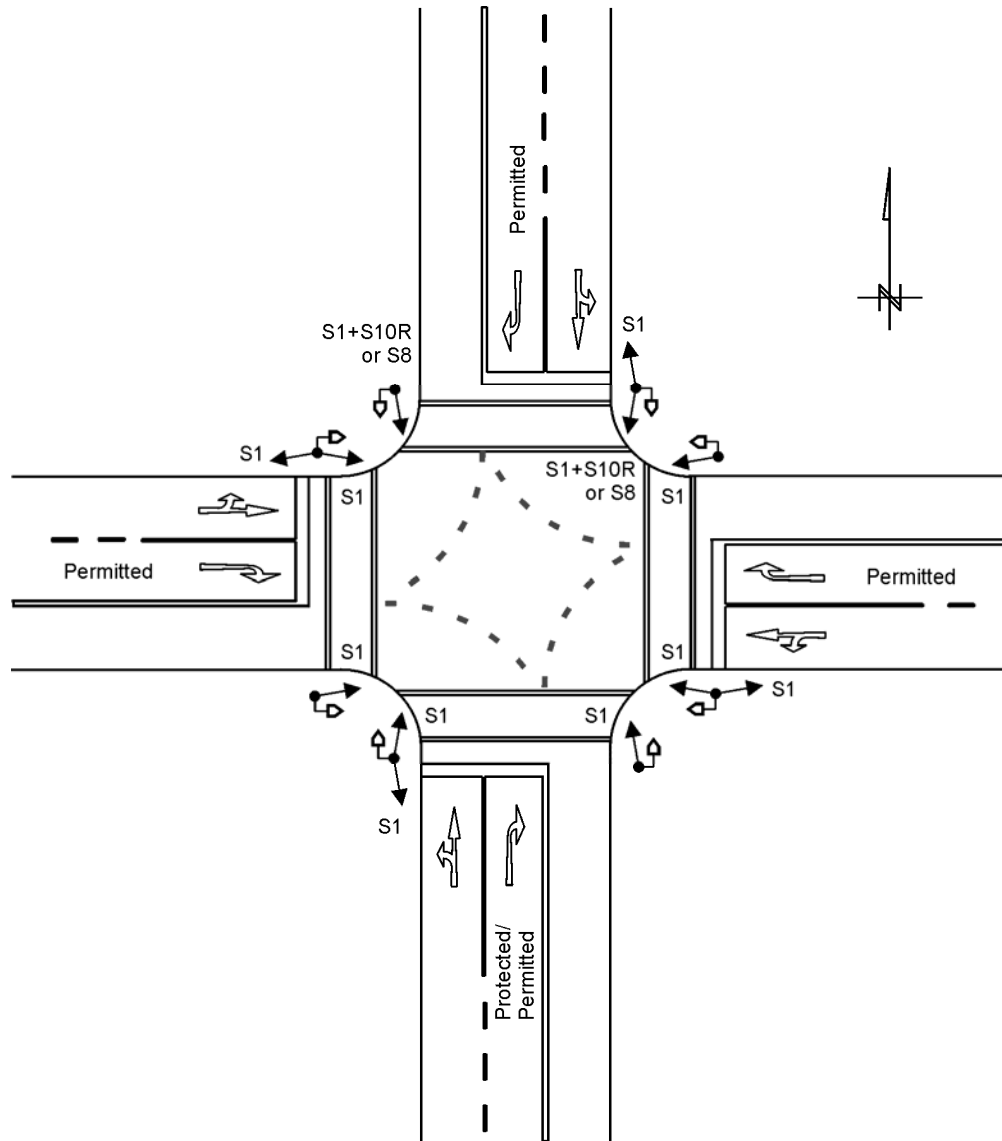

NOTES

- 1 A protected/permitted right-turn phase is provided on the southern approach. This phase is controlled by two principal S10R signal faces on the far side. One of the two S10R signal faces can be provided on the near side, but in this example it is not advisable. The signal faces S1 and S10R can be replaced by single S8 faces.
- 2 No protected right-turn phases are provided on the other approaches and S1 signal faces control all movements. Two principal S1 signal faces are provided on the far side and one principal S1 face on the near side of each of these approaches.
- 3 None of the principal signal faces are further than 20 m apart (preferably 16 m), and no additional overhead faces are required on this account. Overhead faces, however, should be provided on high-speed approaches or when overhead signals have been provided at other junctions on the two streets.

Diagram B.02: Example of a four-way junction with a protected/permitted right-turn phase

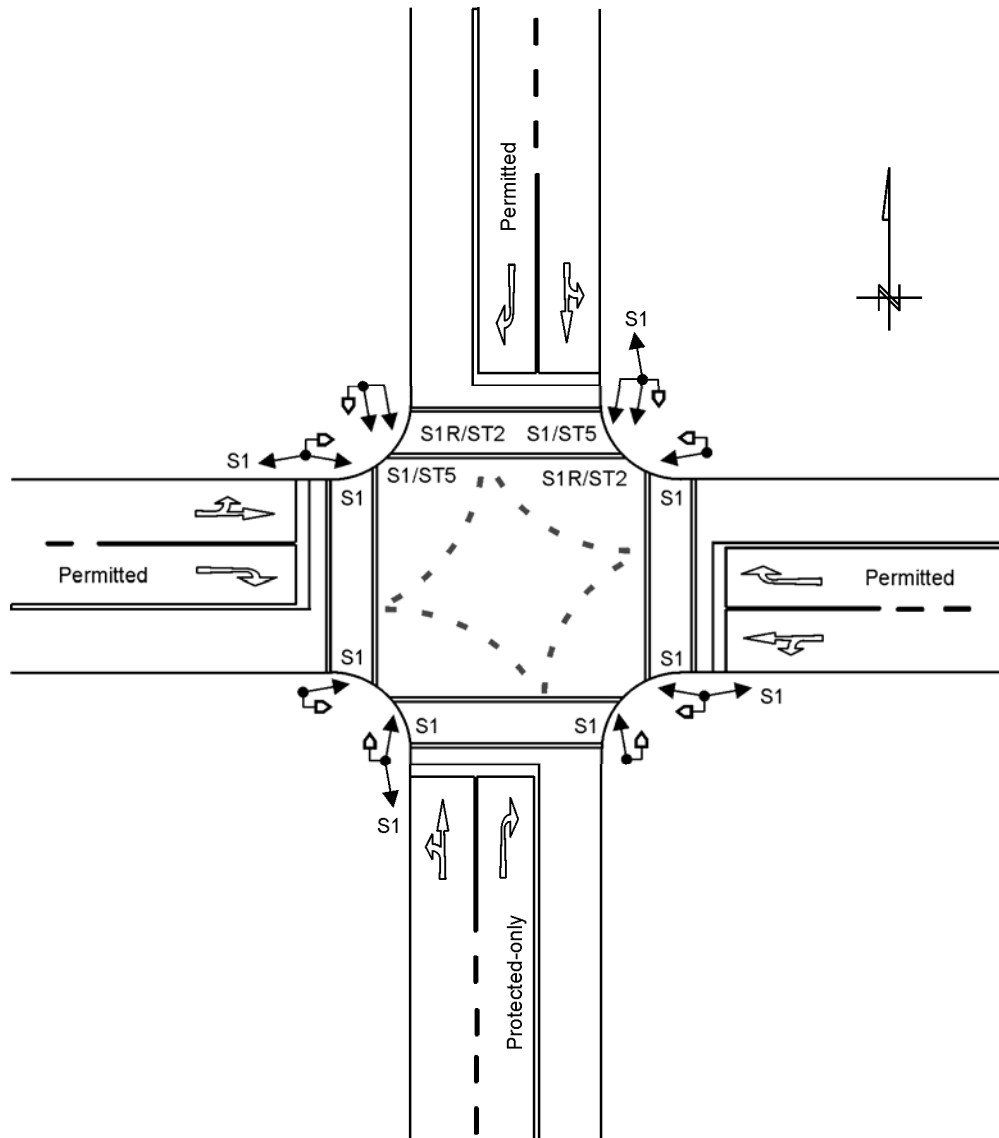

## NOTES

- 1 A protected-only right-turn phase is provided on the southern approach. This phase is controlled by two principal S1R faces combined with ST2 traffic signal arrow signs on the far side. Two of the far side S1 signal faces have been combined with ST5 traffic signal arrow signs. This combination is optional, but recommended when the S1 and S1R signal faces are erected immediately adjacent to each other.
- 2 No protected right-turn phases are provided on the other approaches and S1 signal faces control all movements. Two principal S1 signal faces are provided on the far side and one principal S1 face on the near side of each of these approaches.
- 3 None of the principal signal faces are further than 20 m apart (preferably 16 m), and no additional overhead faces are required on this account. Overhead faces, however, should be provided on high-speed approaches or when overhead signals have been provided at other junctions on the two streets.

Diagram B.03: Example of a four-way junction with a protected-only right-turn phase

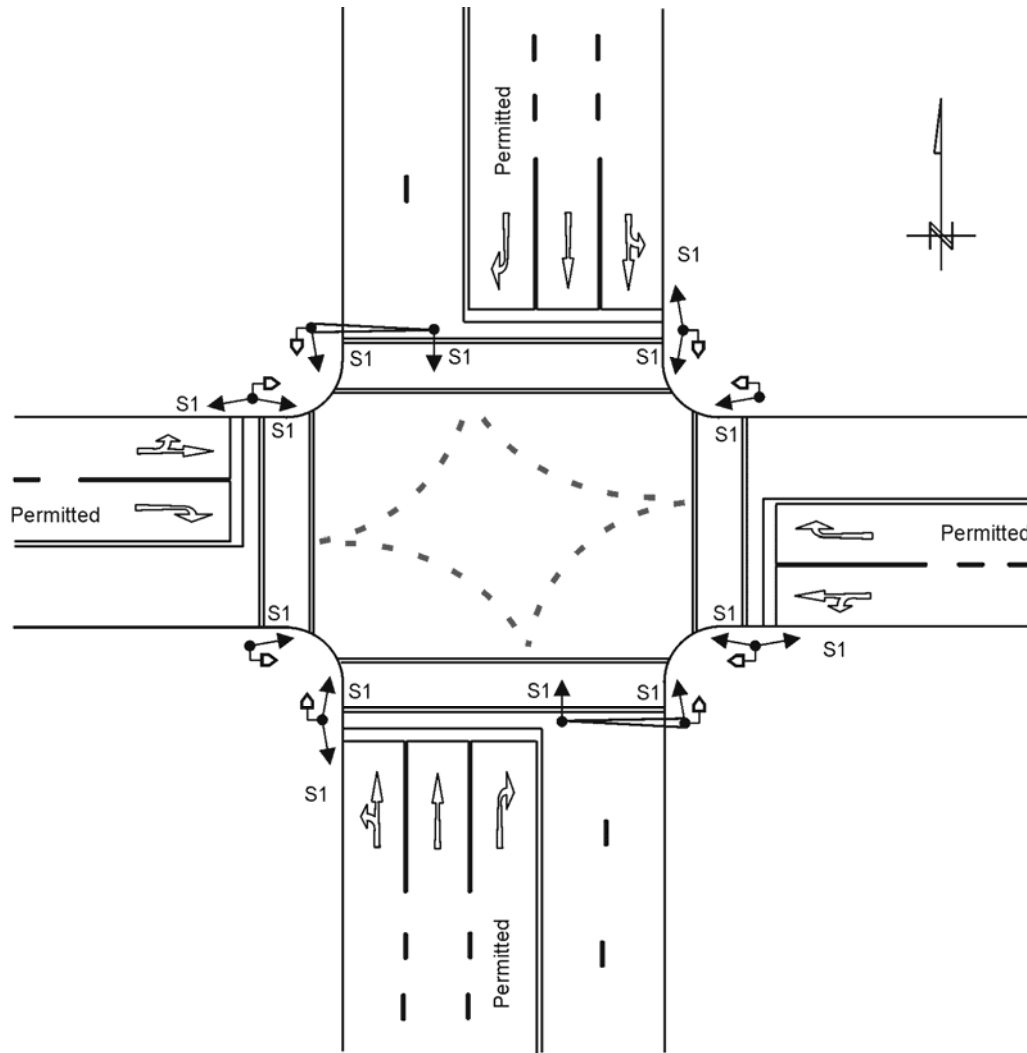

NOTES

- 1 No protected right-turn phases are provided and S1 signal faces control all movements. All approaches have two principal S1 signal faces on the far side and one principal S1 on the near side.
- 2 The northern and southern approaches have a third additional principal signal face S1 mounted overhead on the far side. This signal face has been provided to meet the requirement that signal faces may not be further than 20 m apart (preferably 16 m).
- 3 The eastern and western approaches have not been provided with overhead signal faces since none of the principal signal faces are further than 20 m apart (preferably 16 m). Such faces, however, should be provided on high-speed approaches or when overhead signals have been provided at other junctions on the street.

Diagram B.04: Example of a wide four-way junction with no protected right-turn phases

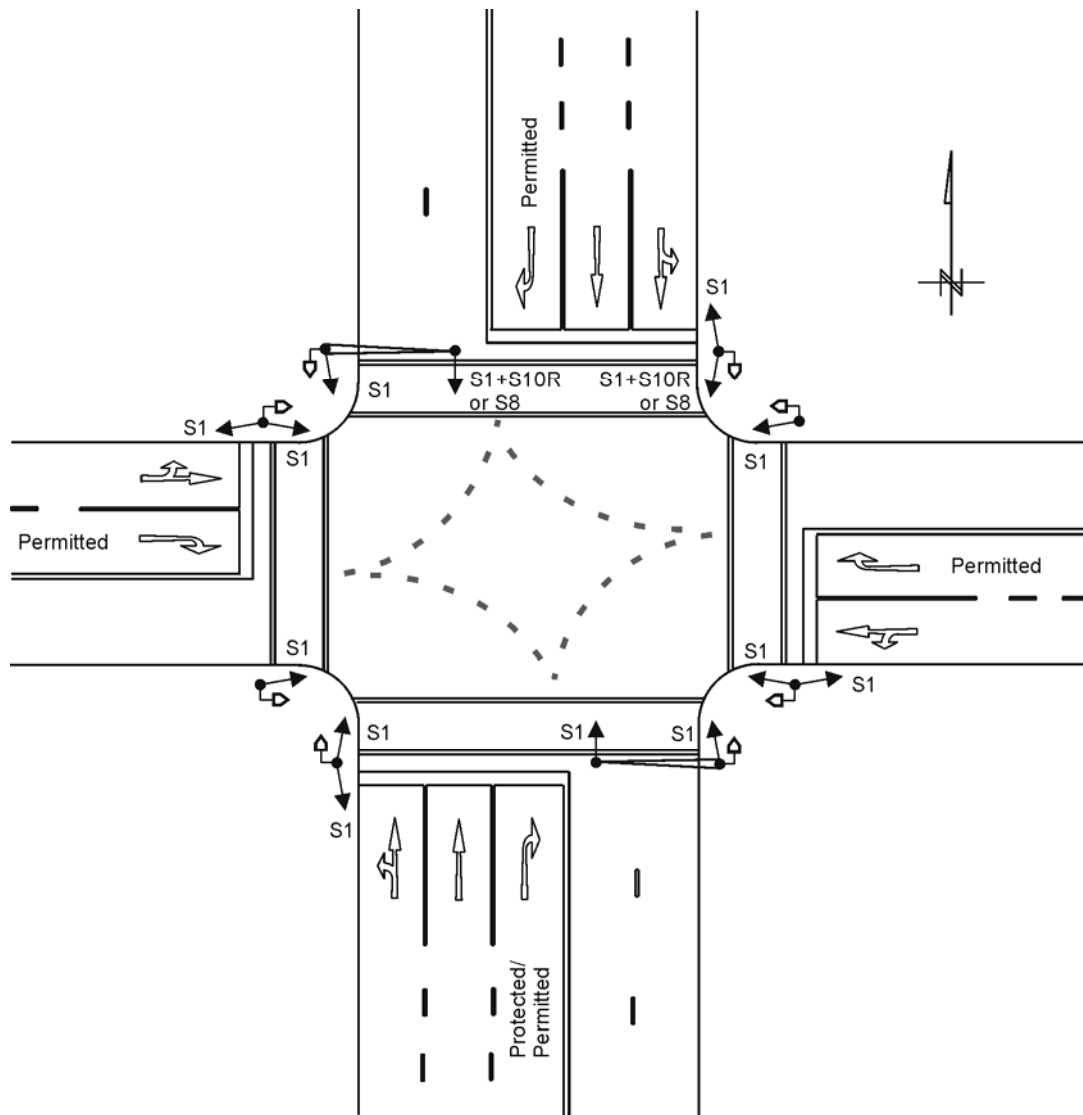

## NOTES

- 1 A protected/permitted right-turn phase is provided on the southern approach. This phase is controlled by two principal S10R signal faces on the far side (one of the two S10R signal faces can be provided on the near side, but in this example it is not advisable). The left-hand signal face S10R has been mounted overhead together with a principal S1 signal face. Both the far-side signal faces S1 and S10R can be replaced by single S8 signal faces.
- 2 No protected right-turn phases are provided on the other approaches and S1 signal faces control all movements. Two principal S1 signal faces are provided on the far side and one principal S1 face on the near side of each of these approaches. The northern approach has a third additional principal signal face S1 mounted overhead on the far side due to the width of the junction.
- 3 The eastern and western approaches have not been provided with overhead signal faces since none of the principal signal faces are further than 20 m apart (preferably 16 m). Such faces, however, should be provided on high-speed approaches or when overhead signals have been provided at other junctions on the street.

Diagram B.05: Example of a wide four-way junction with a protected/permitted right-turn phase

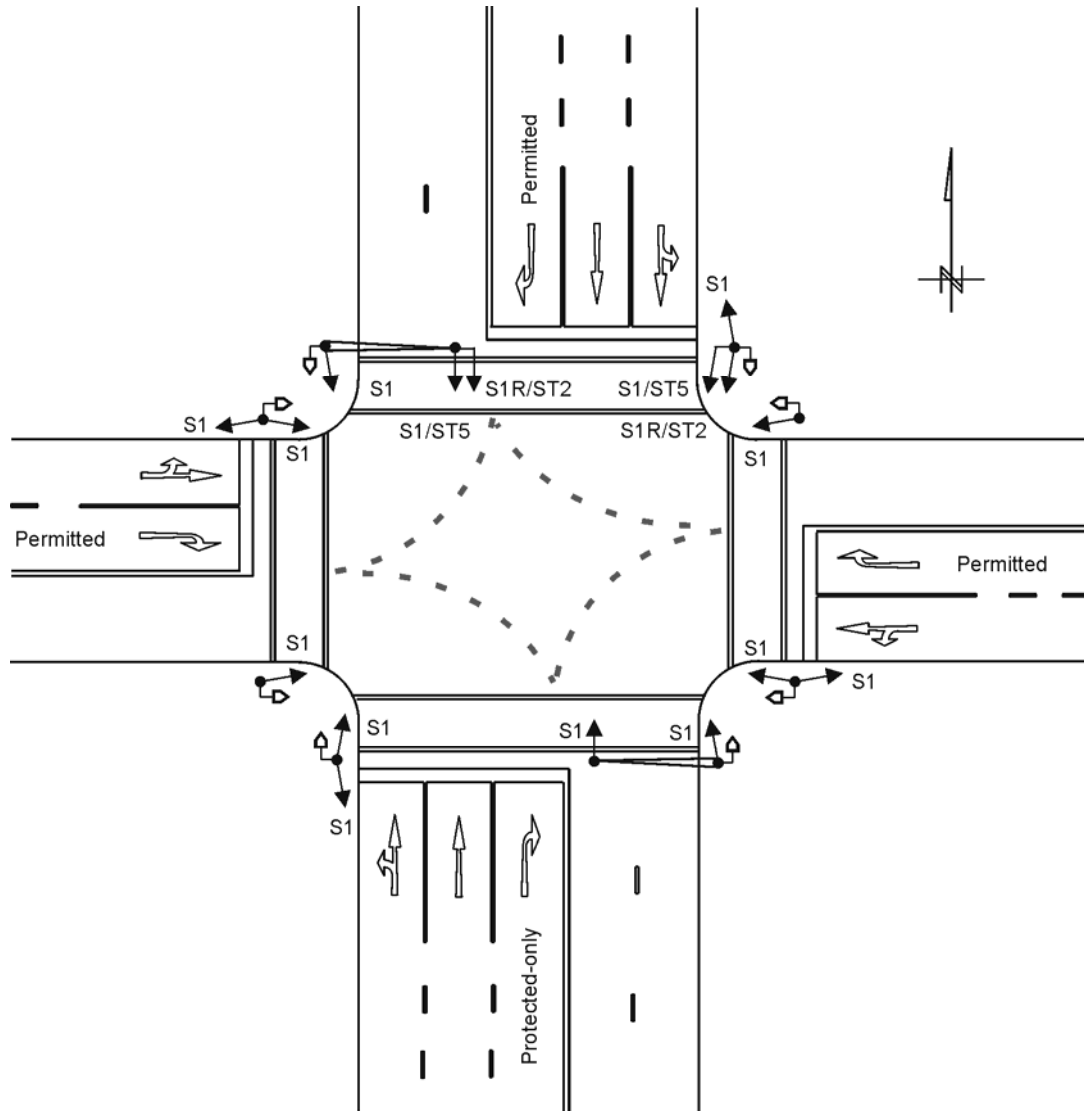

NOTES

- 1 A protected-only right-turn phase is provided on the southern approach. This phase is controlled by two principal S1R faces combined with ST2 traffic signal arrow signs on the far side. Two of the far side S1 signal faces have been combined with ST5 traffic signal arrow signs. This combination is optional, but recommended when the S1 and S1R signal faces are erected immediately adjacent to each other.
- 2 The left-hand signal face S1R/ST2 has been mounted overhead together with a S1/ST5 signal face. Care must be taken to ensure that the cantilever structure will be able to cope with the additional wind forces resulting from the larger size of the signal faces and arrow signs.
- 3 No protected right-turn phases are provided on the other approaches and S1 signal faces control all movements. Two principal S1 signal faces are provided on the far side and one principal S1 face on the near side of each of these approaches. The northern approach has a third additional principal signal face S1 mounted overhead on the far side due to the width of the junction.
- 4 The eastern and western approaches have not been provided with overhead signal faces since none of the principal signal faces are further than 20 m apart (preferably 16 m). Such faces, however, should be provided on high-speed approaches or when overhead signals have been provided at other junctions on the street.

Diagram B.06: Example of a wide four-way junction with a protected-only right-turn phase

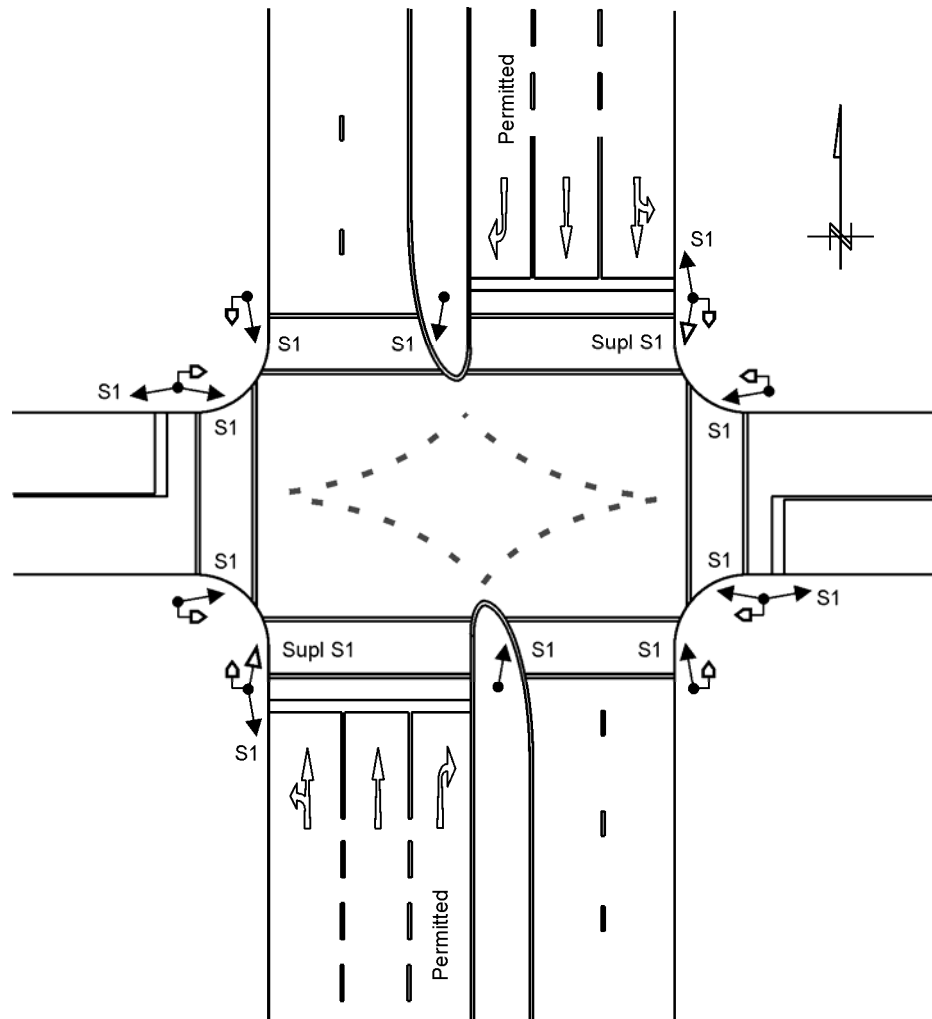

## NOTES

- 1 No protected right-turn phases are provided and S1 signal faces control all movements. All approaches have two principal S1 signal faces on the far side and one principal S1 signal face on the near side.
- 2 When a median is provided with adequate space, the principal S1 signal face on the far right-hand side must be placed on this median. This has been done in the above example for the northern and southern approaches.
- 3 The northern and southern approaches have also been provided with supplementary S1 signal faces on the far right-hand side to assist right-turning vehicles. These supplementary signal faces are not prescribed but are recommended when the signal face on the median can be blocked by heavy vehicles or buses turning right from the opposite approach.
- 4 None of the principal signal faces are further than 20 m apart (preferably 16 m), and no additional overhead faces are required on this account. Overhead faces, however, should be provided on high-speed approaches or when overhead signals have been provided at other junctions on the two streets.

**Diagram B.07: Example of a four-way junction with a median and no protected right-turn phases**

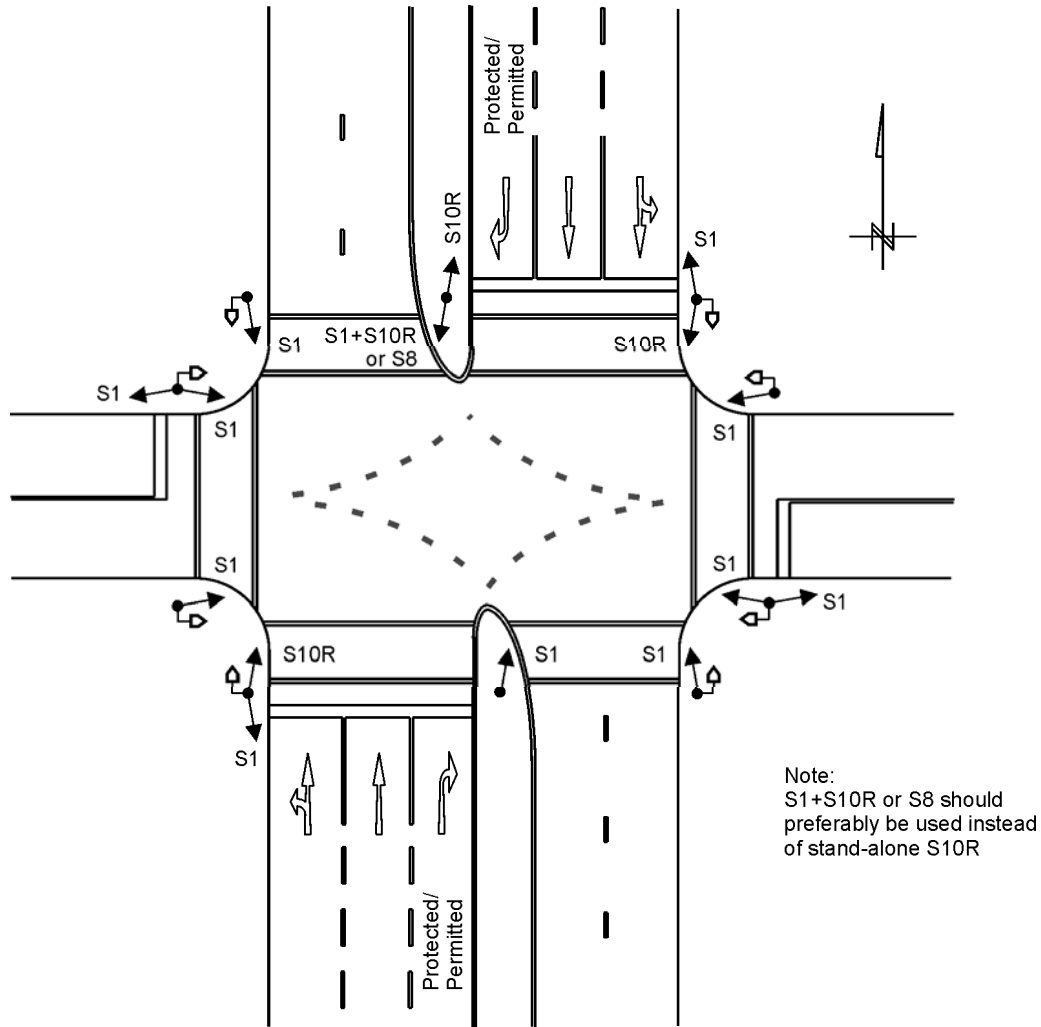

NOTES

- 1 Protected/permitted right-turn phases are provided on the northern and southern approaches. Two different methods for providing the principal signal phases are allowed, as shown for the two approaches. The southern approach is controlled by two principal S10R signal faces on the far side, while the northern approach is controlled by one principal S10R signal face on the far side and one on the near side. Both methods are allowed.
- 2 The stand-alone far-right signal face S10R should preferably be combined with an S1 signal face since no red signal is available in the S10R face. A single S8 signal face can also be used in stead of signal faces S1 and S10R.
- 3 The median in the north/south direction has adequate space, and the principal S1 signal face on the far right-hand side has therefore been placed on the median.
- 4 No protected right-turn phases are provided on the eastern and western approaches and S1 signal faces control all movements. Two principal S1 signal faces are provided on the far side and one principal S1 face on the near side of each of these approaches.
- 5 None of the principal signal faces are further than 20 m apart (preferably 16 m), and no additional overhead faces are required on this account. Overhead faces, however, should be provided on high-speed approaches or when overhead signals have been provided at other junctions on the two streets.

Diagram B.08: Example of a four-way junction with median and protected/permitted right-turn phases

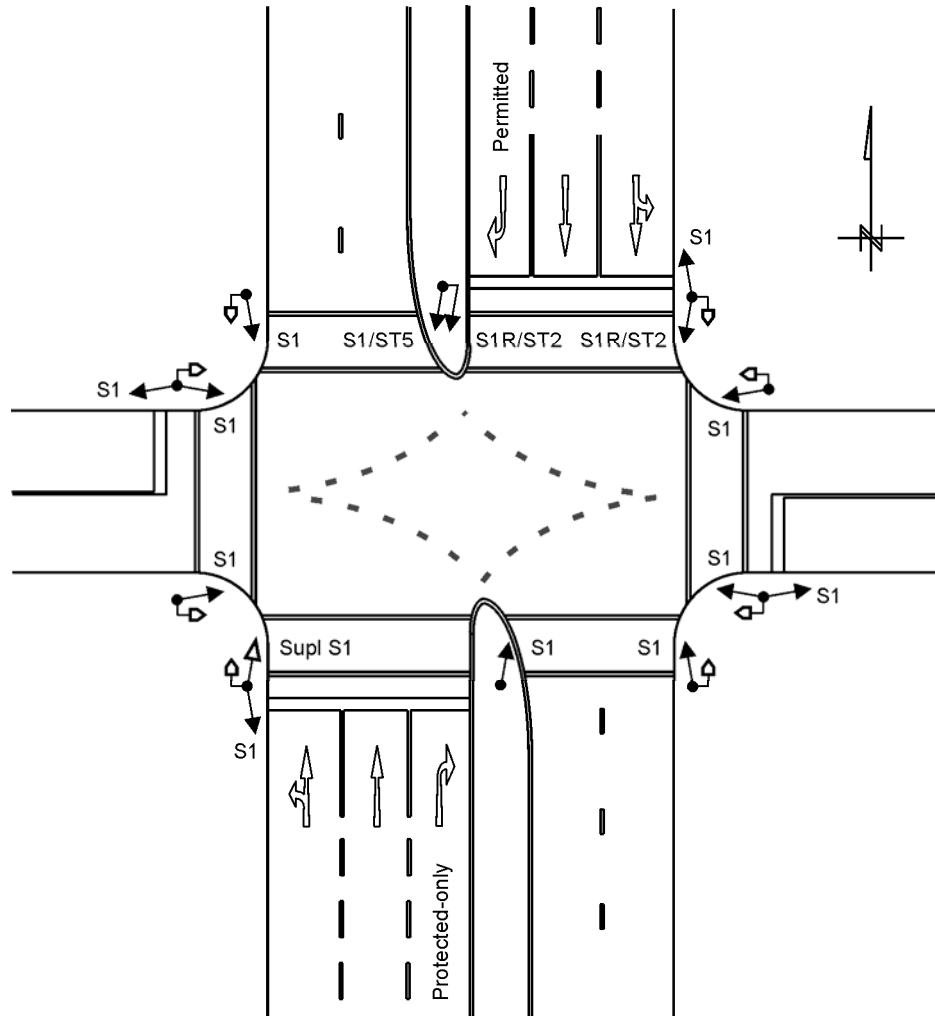

## NOTES

- 1 A protected-only right-turn phase is provided on the southern approach. This phase is controlled by two principal S1R faces combined with ST2 traffic signal arrow signs on the far side. One of the far-side S1 signal faces have been combined with a ST5 traffic signal arrow sign. This combination is optional, but recommended when the S1 and S1R signal faces are erected immediately adjacent to each other.
- 2 The median in the north/south direction has adequate space, and the principal S1 signal face on the far right-hand side has therefore been placed on the median.
- 3 No protected right-turn phases are provided on the other approaches and S1 signal faces control all movements. Two principal S1 signal faces are provided on the far side and one principal S1 face on the near side of each of these approaches.
- 4 The northern approach has been provided with a supplementary S1 signal face on the far right-hand side to assist right-turning vehicles. This supplementary signal face is not prescribed but is recommended when the signal face on the median can be blocked by heavy vehicles or buses turning right from the opposite (southern) approach.
- 5 None of the principal signal faces are further than 20 m apart (preferably 16 m), and no additional overhead faces are required on this account. Overhead faces, however, should be provided on high-speed approaches or when overhead signals have been provided at other junctions on the two streets.

**Diagram B.09: Example of a four-way junction with a median and a protected-only right-turn phase**



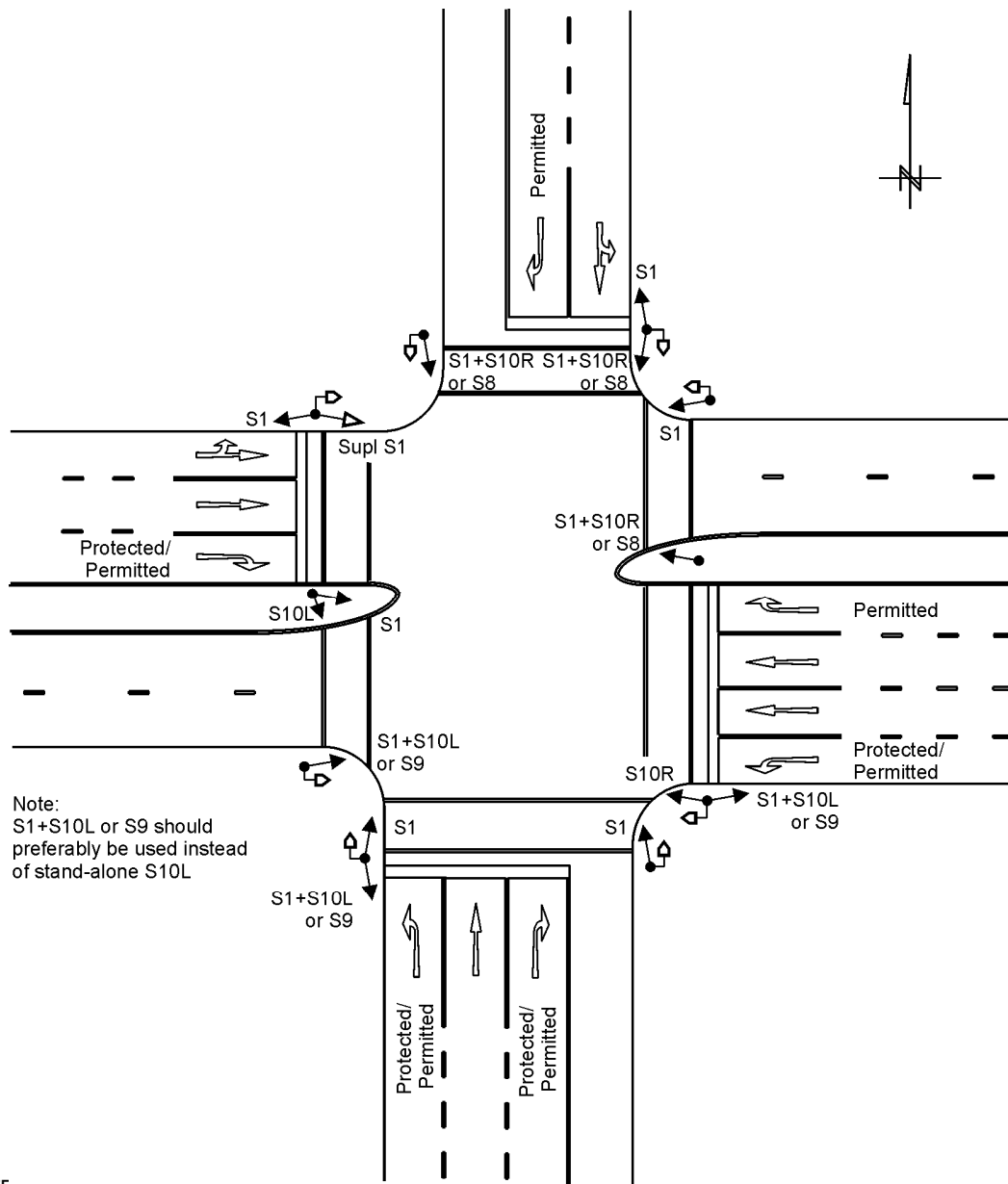

NOTES

- 1 Protected/permitted left-turn phases are provided on the southern and eastern approaches. These phases are controlled by two principal S10L signal faces, one on the near side and the second on the far side of the stop line. For the southern approach, the second principal S1L signal face has been provided on the median (this face could also have been provided on the far left-hand side of the junction).
- 2 Protected/permitted right-turn phases are provided on the southern and western approaches. The left-turn phase on the southern approach and the right-turn phase on the western approach operate at the same time, while the left-turn phase on the eastern approach and the right-turn phase on the southern approach operate together. The right-turn phases are controlled by two principal S10R signal faces. Some of the S1 and S10R signal faces can be replaced by single S8 signal faces.
- 3 The median in the east/west direction has adequate space, and the principal S1 signal faces on the far right-hand side have therefore been placed on the median.
- 4 The eastern approach has been provided with a supplementary S1 signal face on the far right-hand side to assist right-turning vehicles. This supplementary signal face is not prescribed but is recommended when the signal face on the median can be blocked by heavy vehicles or buses turning right from the opposite (western) approach.

Diagram B.10: Example of a four-way junction with protected left-turn phases

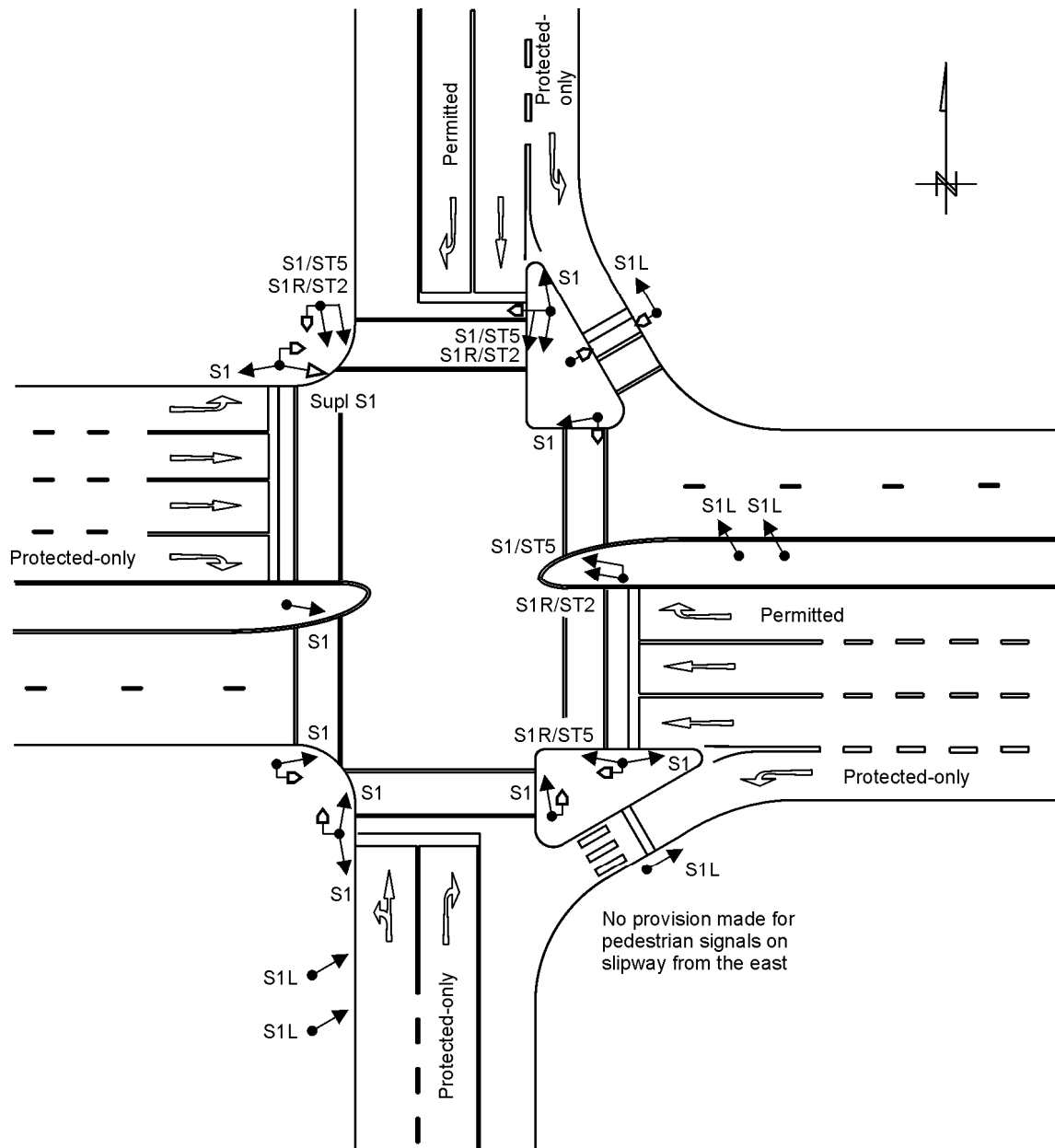

## NOTES

- 1 Signalised left-turn slipways are provided on the northern and eastern approaches. Pedestrian signals have been provided on the northern slipway, but not on the eastern approach slipway.
- 2 All the slipways are controlled by three principal S1L signal faces, two on the far side and one on the near side. The far-side signals on the northern approach are provided on the median.
- 3 Protected-only right-turn phases are required on the southern and western approaches to also protect vehicles turning left on the northern and eastern approaches respectively. These phases are controlled by two principal S1R faces combined with ST2 traffic signal arrow signs on the far side. Some of the far-side S1 signal faces have been combined with a ST5 traffic signal arrow sign (such a combination is optional, but recommended when the S1 and S1R signal faces are erected immediately adjacent to each other).
- 4 None of the principal signal faces are further than 20 m apart (preferably 16 m), and no additional overhead faces are required on this account. Overhead faces, however, should be provided on high-speed approaches or when overhead signals have been provided at other junctions on the two streets.

Diagram B.11: Example of a four-way junction with signalised left-turn slipways

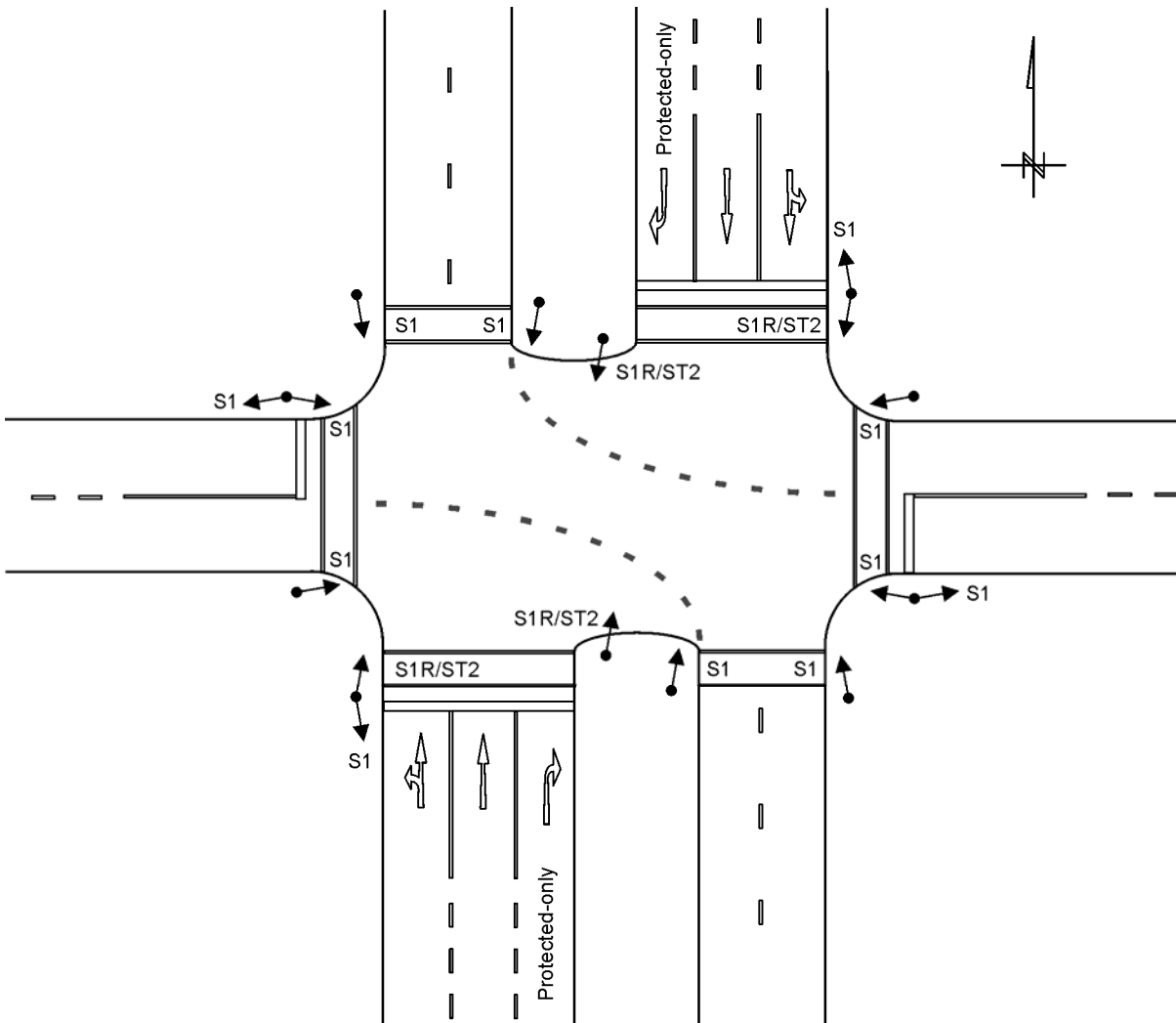

NOTES

- 1 Due to the wide median, sight distance for right-turn movements can be obstructed by queues of right-turning vehicles. Where possible, this problem should preferably be addressed by geometric improvements (an example of which is shown in the next diagram B.13). The problem can, however, also be addressed by providing protected-only right-turn phases (for the southern and northern approaches in the example).
- 2 The protected-only right-turn phases on the southern and northern approaches are controlled by two principal S1R signal faces combined with ST2 traffic signal arrow signs on the far side.
- 3 The median in the north/south direction has adequate space, and the principal S1 signal faces on the far right-hand side have therefore been placed on the median. None of these S1 signal faces have been combined with a ST5 traffic signal arrow sign. Such a combination is only recommended when the S1 and S1R signal faces are erected immediately adjacent to each other. Due to the width of the medians, the two signal faces have been erected on different signal posts.
- 4 No protected right-turn phases are provided on the eastern and western approaches and S1 signal faces control all movements. Two principal S1 signal faces are provided on the far side and one principal S1 face on the near side of each of these approaches.
- 5 None of the principal signal faces are further than 20 m apart (preferably 16 m), and no additional overhead faces are required on this account. Overhead faces, however, should be provided on high-speed approaches or when overhead signals have been provided at other junctions on the two streets.

Diagram B.12: Example of a four-way junction with very wide medians

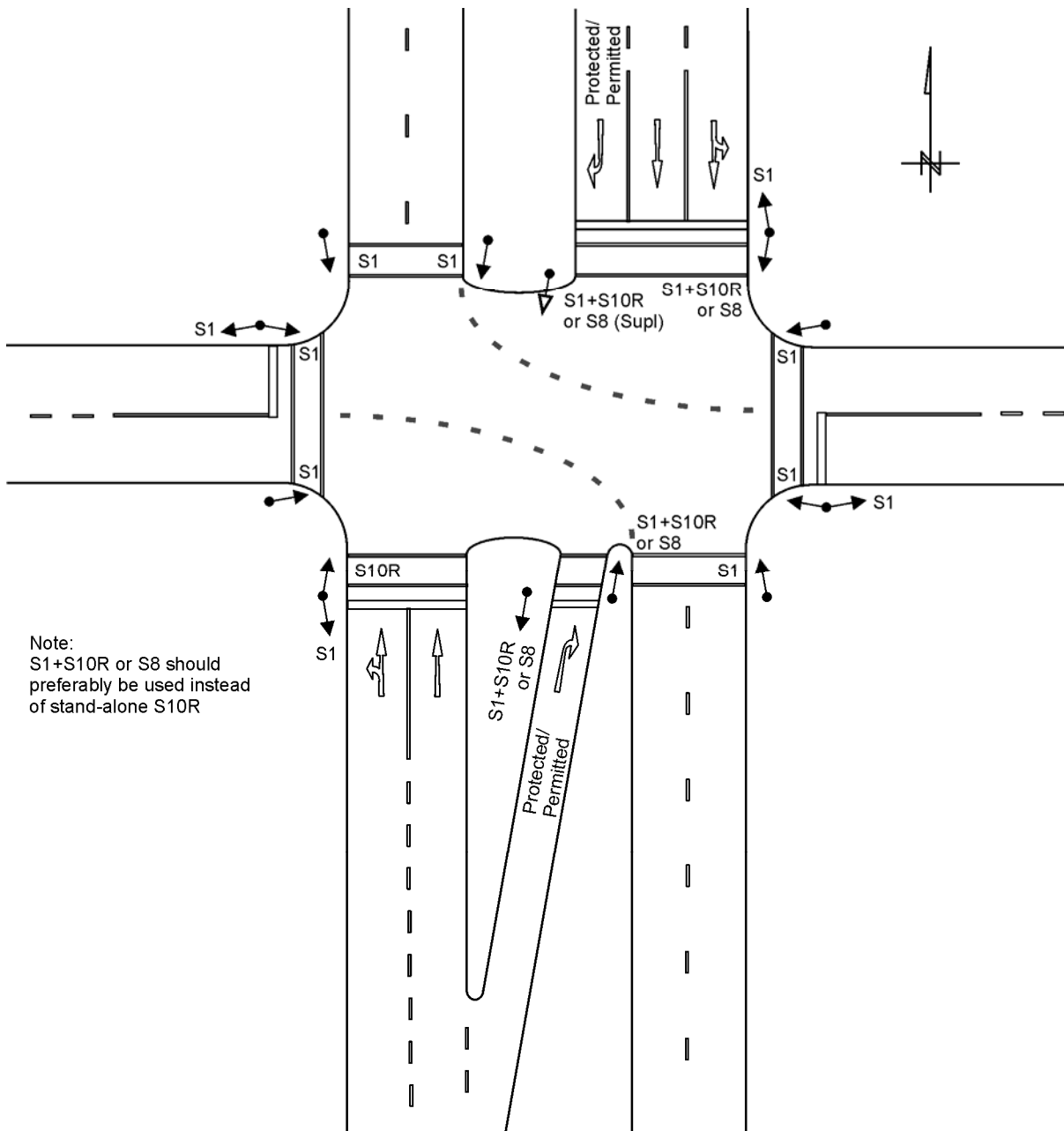

NOTES

- 1 Sight distances for right-turn movements can be obstructed due to the wide median and queues of right-turn vehicles. This problem can be addressed by providing protected-only right-turn phases, but the preferred method of improvement is by providing a right-turn lane within the median as shown above.
- 2 The right-turn movements can be controlled as permitted movements, or by providing either protected/permitted or protected-only right-turn phases. In the example above, protected/permitted right-turn phases are provided on both the southern and northern approaches.
- 3 Two permissible methods for controlling the right-turn movements are shown for the southern and northern approaches. The northern approach is controlled by two principal S10R signal faces on the far side, while the southern approach is controlled by one principal S10R signal face on the far side and one on the near side. A supplementary S10R traffic signal face (together with a S1R face) is provided on the far side to improve visibility.
- 4 The stand-alone far-right signal face S10R should preferably be combined with an S1 signal face since no red signal is available in the S10R face. A single S8 signal face can also be used in stead of signal faces S1 and S10R.

Diagram B.13: Example of a four-way junction with a right-turn lane provided in the median

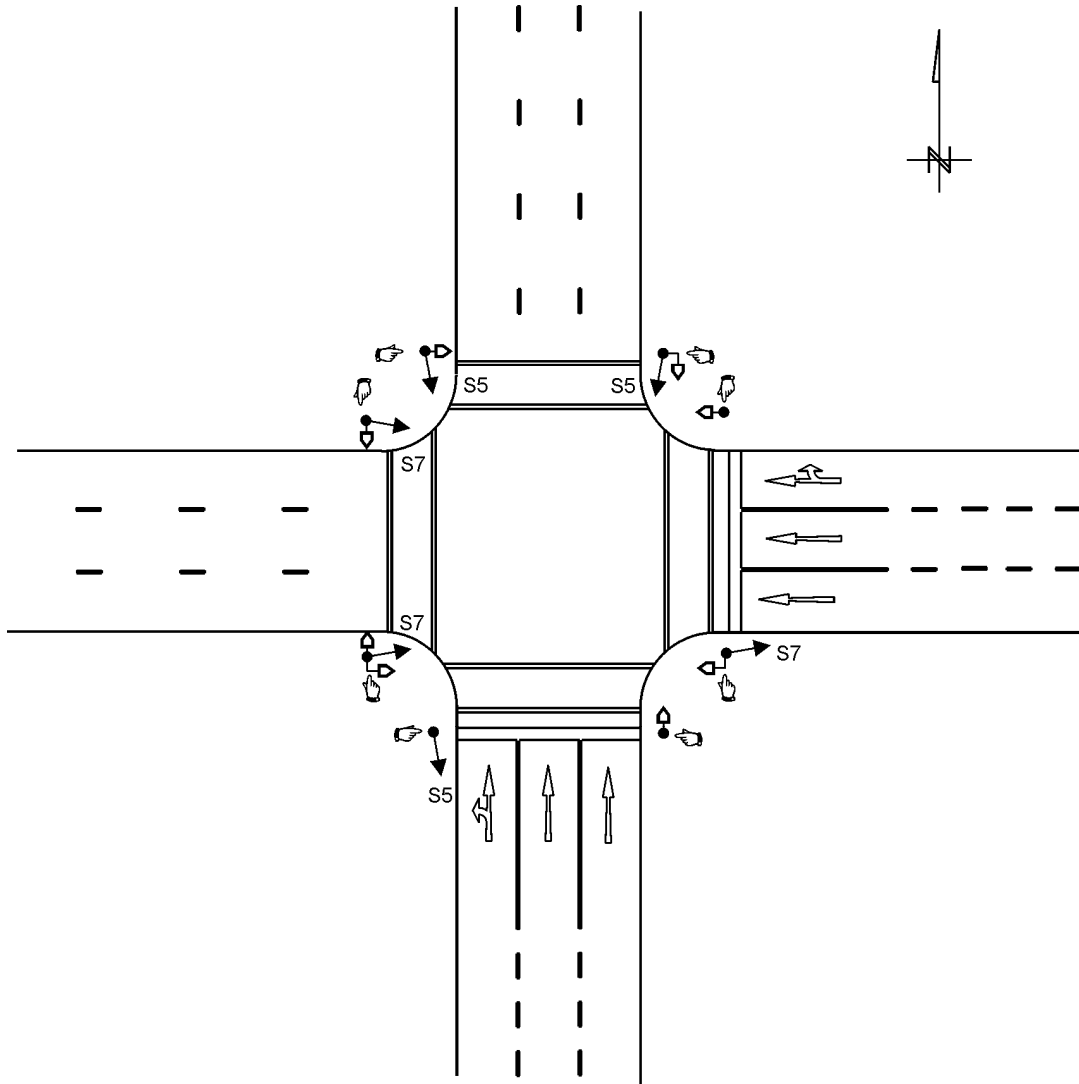

NOTES

- 1 This is an example of a junction of two one-way streets. No protected right-turn phases are provided or are required. Pedestrian signals and push buttons are provided.
- 2 The southern approach is controlled by S5 signal faces that incorporate left-turn and straight-through green arrow signal aspects. Two principal signal faces are provided on the far side and one on the near side.
- 3 The eastern approach is controlled by S7 signal faces that incorporate straight-through and right-turn green arrow signal aspects. Two principal signal faces are provided on the far side and one on the near side.
- 4 None of the principal signal faces are further than 20 m apart (preferably 16 m), and no additional overhead faces are required on this account. Overhead faces, however, should be provided on high-speed approaches or when overhead signals have been provided at other junctions on the two streets.

Diagram B.14: Example of a four-way junction between two one-way roads

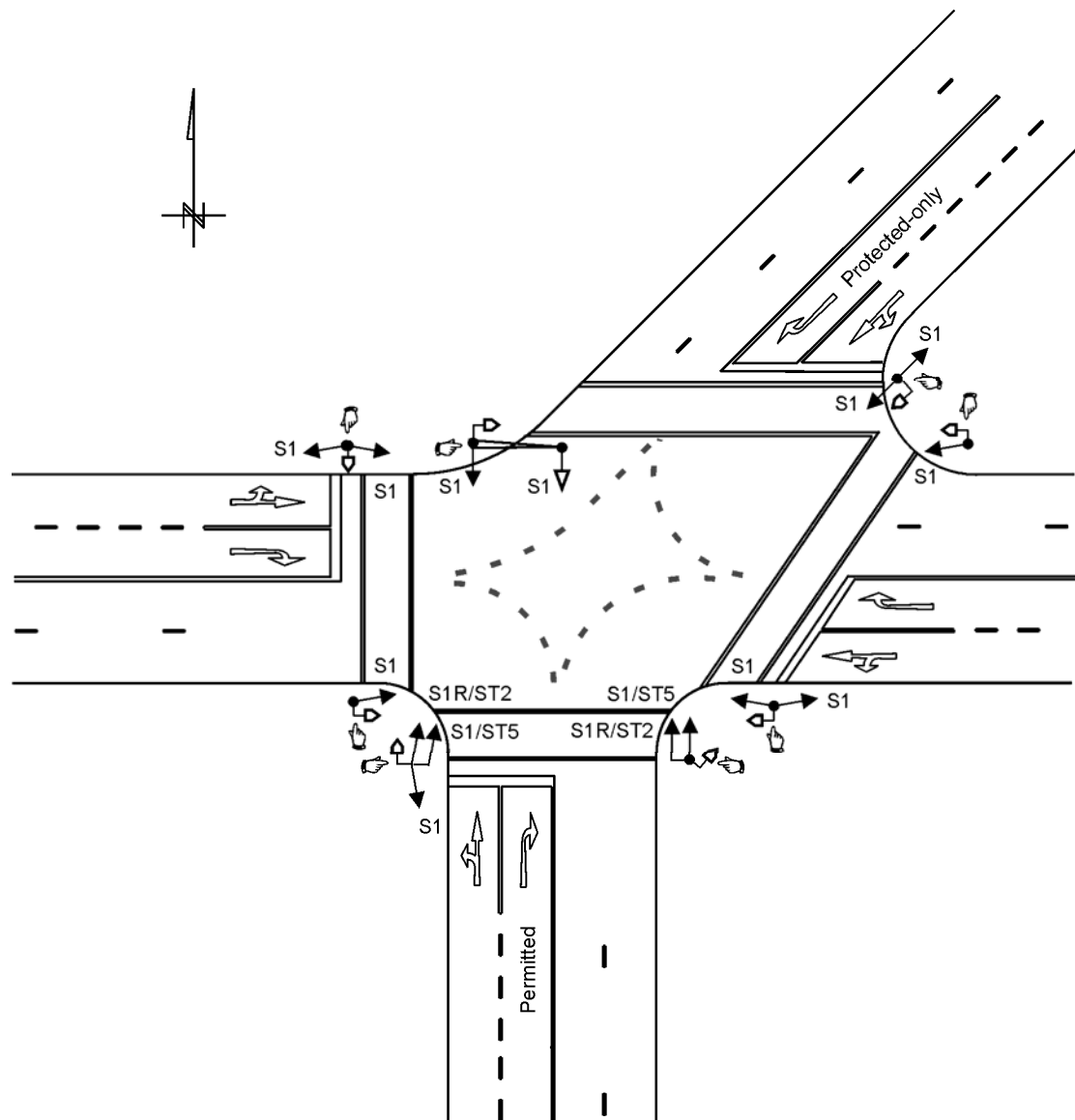

## NOTES

- 1 This is an example of a skewed junction where the angle of skew exceeds 70 degrees. This is not ideal, and geometric improvements should preferably be introduced to reduce the angle of skew.
- 2 A protected-only right-turn phase is provided from the north due to the obstruction of sight distances by queues of right-turning vehicles on the southern approach. Note that in the example, the sight distance from the south is not restricted by such queued vehicles on the northern approach.
- 3 The protected-only right-turn phase on the northern approach is controlled by two principal S1R faces combined with ST2 traffic signal arrow signs on the far side. The far-side S1 signal faces have been combined with a ST5 traffic signal arrow sign. Such a combination is optional, but is recommended when S1 and S1R signal faces are erected immediately adjacent to each other.
- 4 None of the principal signal faces are further than 20 m apart (preferably 16 m), and no additional overhead faces are required on this account. A supplementary overhead S1 signal face, however, is provided in order to meet visibility requirements from the south.

Diagram B.15: Example of a skew four-way junction with protected-only right-turn phases.

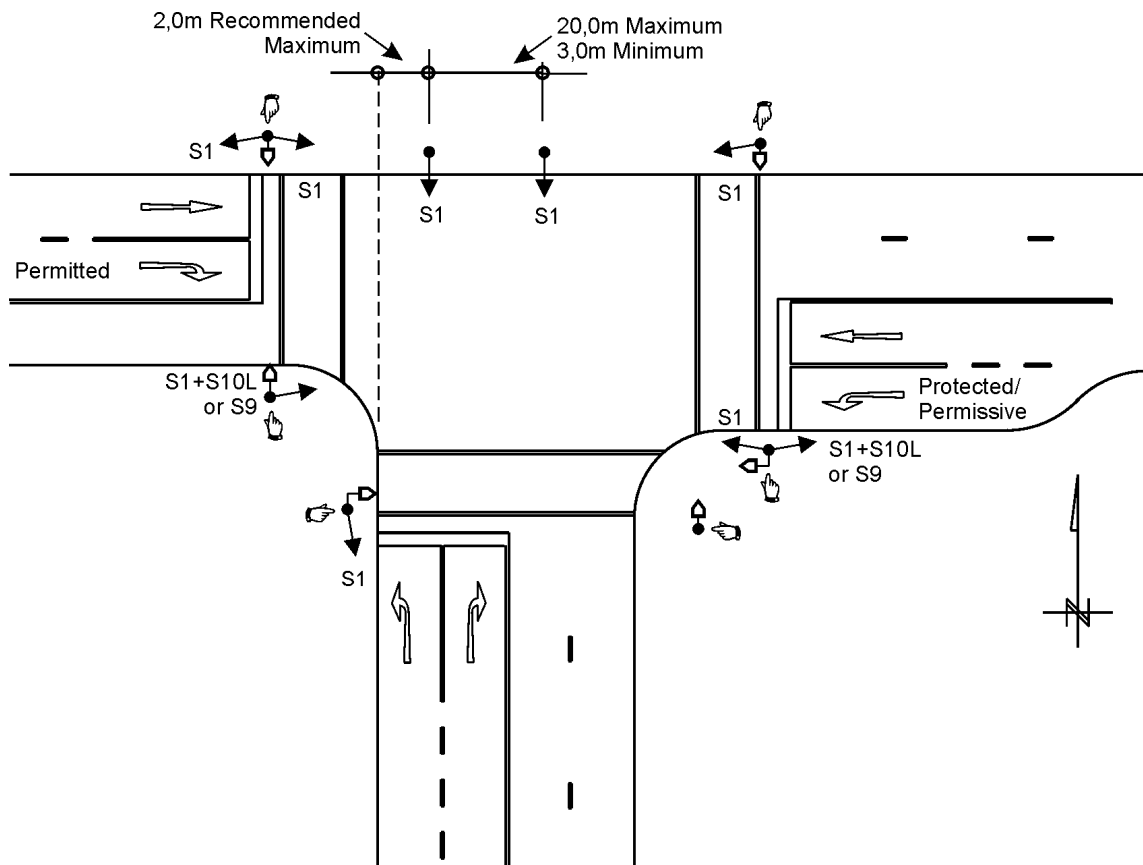

NOTES

- 1 All turning movements are controlled by S1 signal faces, except for the left-turn movement from the east. Two principal S1 signal faces are provided on the far side, and one principal S1 face on the near side of each approach.
- 2 The left-turn movement from the east is controlled by two principal S10L signal faces, one on the near side and one on the far side. The S1 and S10L signal faces can be replaced by combined S9 signal faces. Care must be taken that the green arrow light signal in the S10L is not flashed when a green signal is provided to a conflicting vehicular or pedestrian traffic stream.
- 3 The southern approach does not continue straight through the junction, and it is not possible to provide the far side principal signal faces S1 on the left- and right-hand sides of the road. The faces are therefore positioned opposite the approach lanes at locations where they are at least 3 m apart, but not further than 20 m apart. It is recommended that the left-hand face not be located further than 2 m from the continuation of the left-hand edge of the approaching roadway.

Diagram B.16: Example of a signalised T-junction

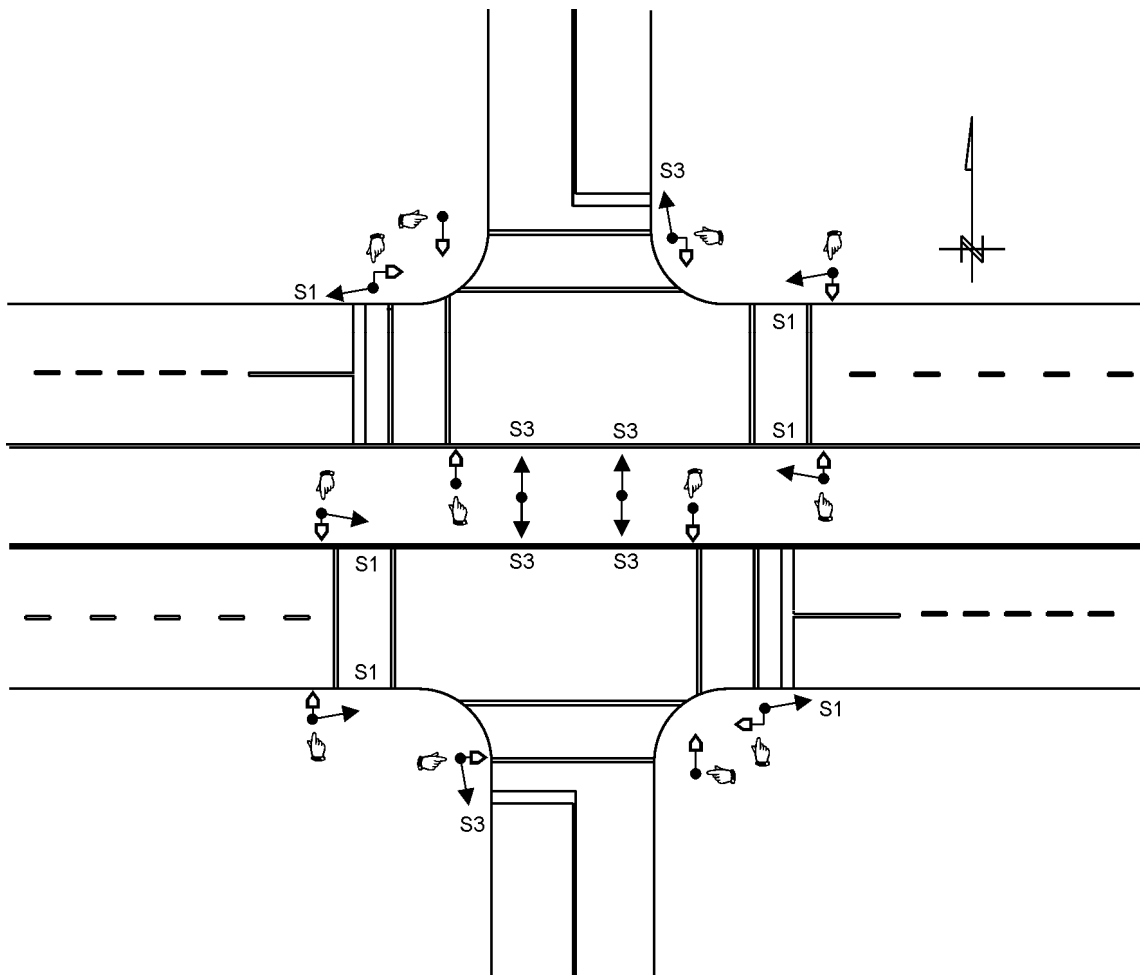

## NOTES

- 1 The east-west road is subdivided by a constructed median that continues through the junction. The junction can therefore be treated as two separate individual T-junctions, and signal faces provided accordingly. The signals do not have to be co-ordinated and can be independently timed.
- 2 The two carriageways in the east-west direction can be treated as one-way roads, allowing the use of the S3 traffic signal faces. Two of the faces are provided on the far side and one on the near side as principal signal faces.
- 3 The pedestrian crossings in the north/south direction should be staggered to reduce the possibility of confusion when different coloured pedestrian signals are displayed in this direction.

Diagram B.17: Example of a four-way junction divided by a constructed median



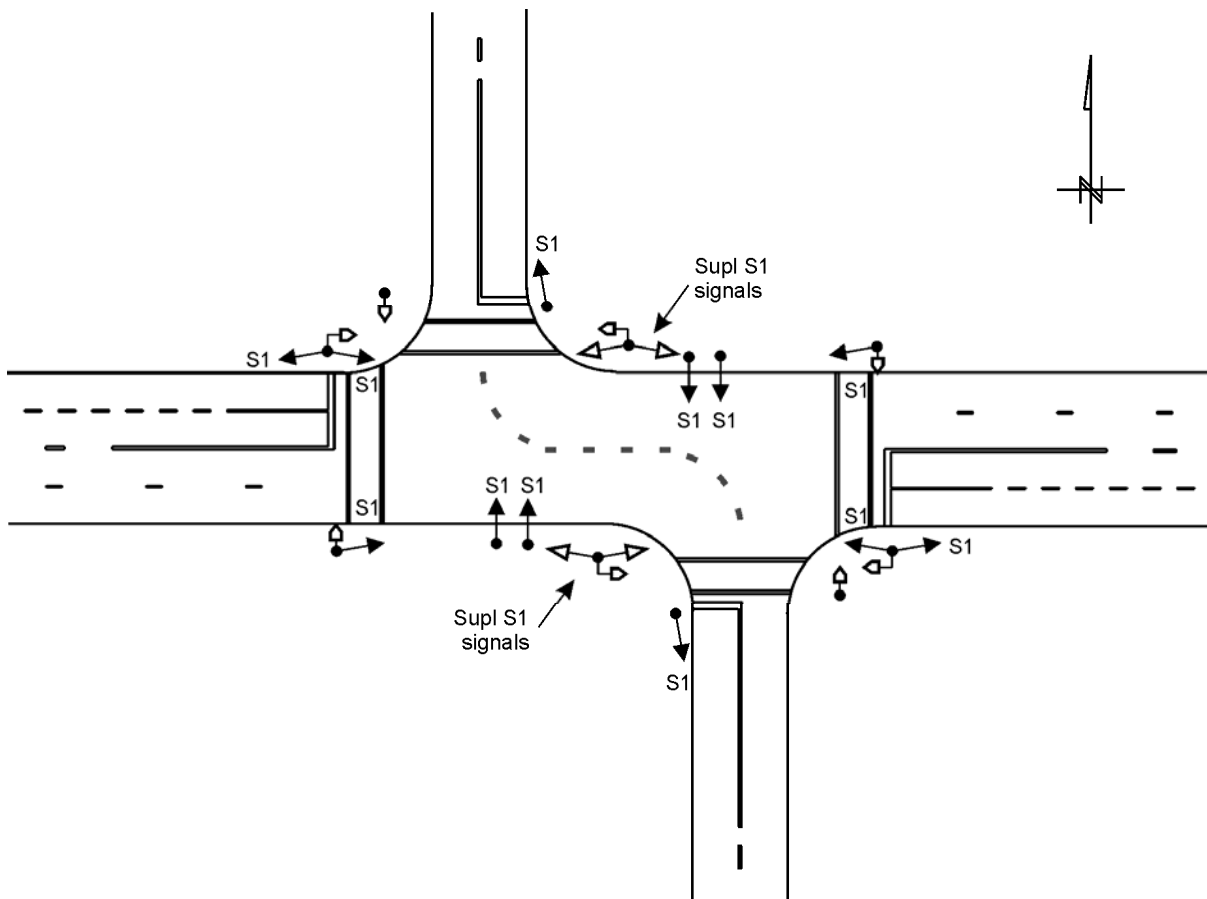

## NOTES

- 1 The above is an example of a staggered junction. Such junctions are difficult to control with traffic signals, and drivers can be confused by the operations of signals. Care must be taken that the signal is not treated as two junctions, particularly if a pedestrian crossing is provided in the middle of the junction as shown in the example.
- 2 The junction in the example is controlled by two vehicular signal phases operated in parallel with pedestrian phases. This may be acceptable while traffic volumes on the staggered street are low. When traffic volumes are high, each of the staggered legs may require a separate signal phase.
- 3 Two principal S1 signal faces are provided on the far side and one principal S1 face on the near side of each approach. Supplementary signal faces are provided for the east-west direction in the middle of the junction to improve the visibility of the signals. The far-side principal signals are situated relatively far from the stop lines, and may not be very clear to drivers. **It is important to note that all the S1 signal faces in one direction must display the same red, yellow and green signal at the same time.** The two far-side principal signal faces may for instance, NOT display green light signals while red light signals are displayed by the supplementary signal faces in the middle of the junction.

Diagram B.18: Example of a staggered four-way junction

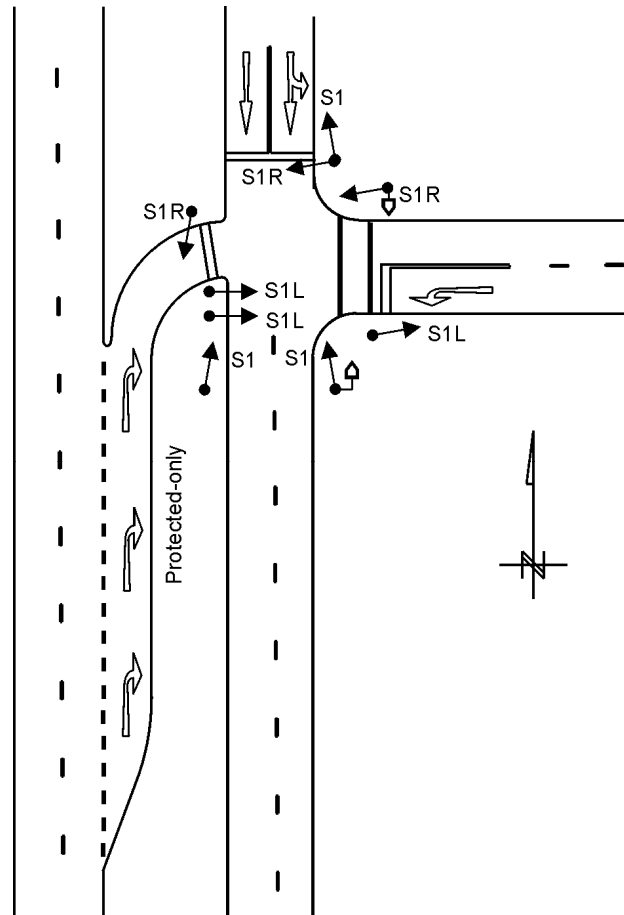

## NOTES

- 1 This type of junction allows for the signalisation of only one carriageway of a double-carriageway road (as shown for the north-to-south direction in the example). The advantage is that signal co-ordination can be maintained, allowing a closer spacing of signalised junctions.
- 2 Three principal signal faces are provided on all approaches, two on the far side and one on the near side. The north-to-south carriageway can effectively be treated as a one-way street, and principal S3 signal faces are therefore provided on the eastern approach.
- 3 The south-to-east right-turning movement is controlled by S1R signal faces. The two far side signal faces are provided on the same corner since it would be confusing if the S1R signal was provided on the far right-hand side corner.

Diagram B.19: Example of a left-in/left-out/right-in junction

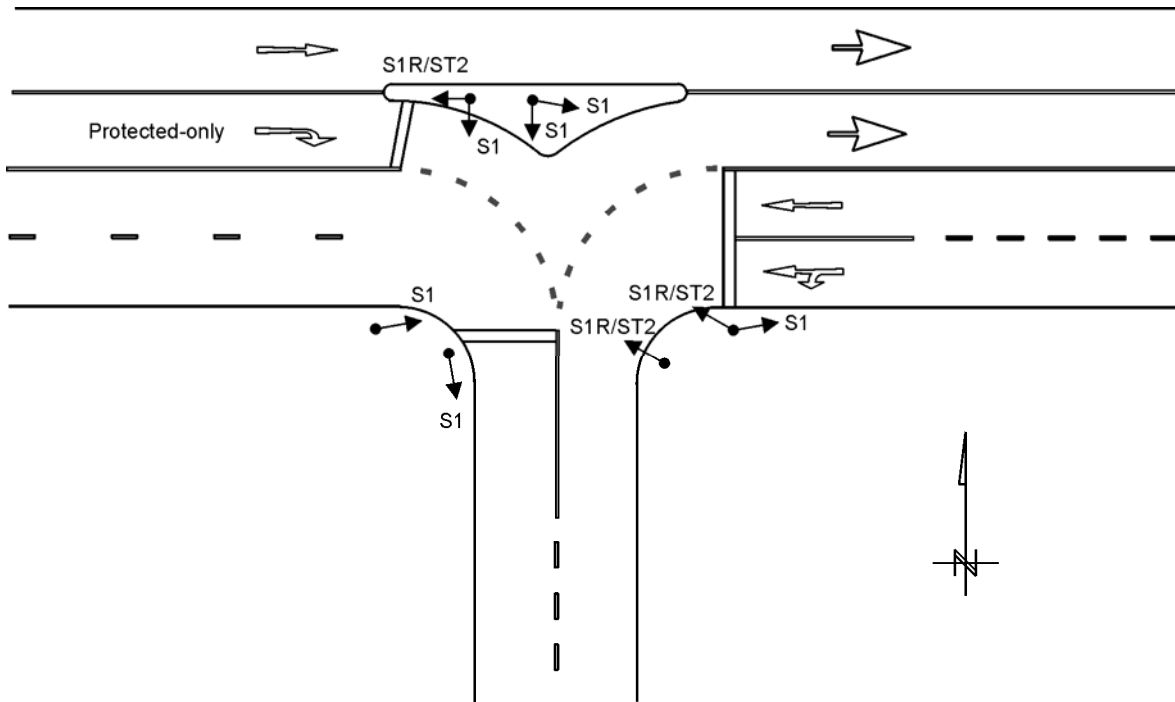

NOTES

- 1 The "butterfly" junction allows for straight-through movement in one direction to by-pass the traffic signal (the western approach in the example). Although the layout of this type of T-junction was specifically developed for priority control, it can also be signalised.
- 2 The advantage of allowing the straight-through movement to by-pass the junction is that signal co-ordination can be maintained, even when traffic signals are spaced closer together. A minimum spacing, however, must still be provided to allow for weaving movements between the straight-through movement travelling from west to east and traffic turning onto the main road downstream of the junction.
- 3 A disadvantage of this design is that it leads to vehicle/pedestrian conflicts. Pedestrians waiting on the median tend to assume that vehicles approach the junction only from the left, without taking note of vehicles approaching from the right. The pedestrians must also cross the uncontrolled straight-through movement. The butterfly design should therefore only be considered when few pedestrians use a junction.

Diagram B.20: Example of a signalised "butterfly" T-junction



## APPENDIX C: TRAFFIC SIGNAL CHECKLISTS

### C.1 TRAFFIC SIGNAL LAYOUT CHECKLIST

| SECTION                 | REQUIREMENT  | CHECKED |
|-------------------------|--|---------|
| <b>GENERAL</b>          |  |         |
| 1.2                     | Location of installation, north arrow  |         |
| 1.2                     | Drawing to scale, Scale shown  |         |
| 30                      | Version number   |         |
| 1.2                     | Signature of responsible registered professional engineer or technologist            |         |
| <b>SIGNAL WARRANTS</b>  |  |         |
| 2.2                     | Minimum requirements for installation of traffic signals met                         |         |
| 2.3                     | Alternatives that may obviate the need for traffic signals not viable or feasible    |         |
| 2.4.2                   | Queue length warrants met  |         |
| <b>SPEED LIMITS</b>     |  |         |
| 3.10                    | Speed limits given. No limit exceeds 80 km/h   |         |
| 3.10                    | Measures on high-speed roads considered (traffic circles, etc.)                      |         |
| <b>BASE PLAN</b>        |  |         |
| 26.4                    | Property boundaries and fences   |         |
| 26.4                    | Roads, islands, medians and paint markings   |         |
| 26.4                    | Approach gradients   |         |
| 26.4                    | Paved sidewalks, driveways   |         |
| 26.4                    | Drainage structures  |         |
| 26.4                    | Plants and vegetation  |         |
| 26.4                    | Engineering services   |         |
| 26.4                    | Roadside furniture   |         |
| 26.4                    | Structures and buildings   |         |
| <b>GEOMETRIC DESIGN</b> |  |         |
| 5.2.3                   | Spacing of signalised junctions acceptable   |         |
| 5.2.4                   | Intersection angle minimum 70 degrees, including slipways                            |         |
| 5.2.5                   | Sight distance requirements met (stopping, traffic signal faces, right-turn)         |         |
| 5.3.4                   | Right-turn sight distance adequate (particularly on wide medians/curves)             |         |
| 5.2.6                   | Design vehicle swept paths   |         |
| 5.2.7                   | Lane widths (approach and exit sides)  |         |
| 5.2.8                   | Median widths (minimum 1,2 m, but 2 m minimum when pedestrians)                      |         |
| 5.2.9                   | Junction corner radius (8 to 10m radii preferred), Barrier kerbs                     |         |
| 5.3.1                   | Auxiliary through lane (100 m beyond junction)                                       |         |
| 5.3.2                   | Left-turn lane provided when there is an opportunity for separate phase              |         |
| 5.3.3                   | Right-turn lane where possible, should be provided when speed exceeds 60 km/h        |         |
| 5.3.6                   | Auxiliary lane designs and lengths   |         |
| 5.3.5                   | Double and triple turn requirements (triple only at T-junctions and one-way streets) |         |
| 5.3.7                   | Slipway design requirements met, 70 degrees maximum                                  |         |
| 3.3                     | Slipways separated from main junction by means of a constructed island               |         |
| 26.4                    | Parking space for signal maintenance vehicles  |         |

| ROAD SIGNS AND MARKINGS |   |  |
|-------------------------|---|--|
| 3.4                     | Control precedence of signs (pedestrian, bus or tram, arrows, disc light signals)       |  |
| 3.4/5.4                 | Road signs that may and may not be used with traffic signals                            |  |
| 5.4                     | Pedestrian prohibited sign R218 provided where required                                 |  |
| 5.4                     | Traffic signal ahead warning signs provided where required (new signals, 70 km/h, etc.) |  |
| 5.5.1                   | Stop lines  |  |
| 5.5.2                   | Pedestrian crossing lines (should be provided, except where sign R218 used)             |  |
| 5.5.3                   | Lane direction arrows   |  |
| 5.5.3                   | Regulatory road markings  |  |
| 5.5.4                   | Warning road markings   |  |
| 5.5.5                   | Guidance road markings  |  |
| 5.3.4                   | When signal face S1R used, right-turn lanes separated by painted island or similar      |  |

| TRAFFIC SIGNAL FACES |  |  |
|----------------------|--|--|
| 3.8                  | Only prescribed traffic signal faces used  |  |
| 3.7                  | No duplicate light signals on one face   |  |
| 3.8                  | Signal arrow signs ST1 to ST5 only used when faces S1L and S1R used                  |  |
| 3.8                  | Signal face S1 not used on same approach as S2, S3, S4, S5, S6 and S7                |  |
| 3.8                  | Signal faces S1R and S1L without ST3 and ST2 on slipways, otherwise with ST3 and ST2 |  |
| 3.8                  | Signal faces S2, S3, S4, S5, S6 and S7 only when specific turns not allowed          |  |
| 3.8                  | Signal faces S2, S6 and S7 not when there is an opposing conflicting movement        |  |
| 3.8                  | Signal faces S10R and S10L preferably not in a stand-alone location                  |  |

| PRINCIPAL SIGNAL FACES |  |  |
|------------------------|--|--|
| 1.2.4                  | Number, type and location of traffic signal faces  |  |
| 3.9.1                  | Two signal faces (containing red signal) on the far side of stop line                      |  |
| 3.9.1                  | Additional far-side signal faces when further apart than 20 m (preferable 16 m)            |  |
| 3.9.1                  | One signal face with red signal on near side (recommended at pedestrian crossings)         |  |
| 3.9.1                  | Two faces with flashing green signals for turning phases (one far side, other far or near) |  |
| 3.9.1                  | Far-side signal faces not nearer than 6 m from stop line (10 m preferable)                 |  |
| 3.9.1                  | Far-side signal faces not less than 3 m apart, nor further than 20 m (16 m preferable)     |  |
| 3.9.2                  | Near-side signal faces not further than 3 m from stop line                                 |  |

| SUPPLEMENTARY SIGNAL FACES |   |  |
|----------------------------|---|--|
| 1.2.4                      | Number, type and location of traffic signal faces                                   |  |
| 3.11                       | At least two signal faces visible over minimum sight distances                      |  |
| 3.11                       | At least two signal faces on far side visible over minimum distance of 50 m         |  |
| 3.11                       | At least one signal face visible in cone of vision                                  |  |
| 3.11                       | At least one signal face visible for right-turning vehicles waiting within junction |  |
| 3.11                       | Additional faces provided for consistency and uniformity                            |  |
| 3.12.3                     | Overhead signals on high-speed roads or to ensure consistency/uniformity            |  |

| MOUNTING OF TRAFFIC SIGNAL FACES |  |  |
|----------------------------------|--|--|
| 3.11                             | No distracting advertisements and features near signal faces                   |  |
| 3.12.1                           | Minimum clearance distance (0,5 or 0,1 m on medians when crossfalls fall away) |  |
| 3.12.2                           | Maximum lateral distance (not further than 2 m from left edge of roadway)      |  |
| 3.12.5                           | Overhead signals on left-hand side of road                                     |  |



| PEDESTRIAN AND PEDAL CYCLIST SIGNALS |   |  |
|--------------------------------------|---|--|
| 1.2                                  | Number, type and location of pedestrian signal faces          |  |
| 4.6                                  | Location of pedestrian signal faces                           |  |
| 4.3                                  | Push buttons provided and pedestrian signals demand dependent |  |
| 4.7                                  | Push button locations and directions                          |  |
| 4.6                                  | Staggered crossing considered                                 |  |

| SIGNAL ASPECTS AND POSTS |   |  |
|--------------------------|---|--|
| 16.2.2                   | Luminous intensity (normal or high – high on roads with speed limit 70 km/h or greater) |  |
| 16.2.3                   | Aspect sizes (210 or 300 mm)  |  |
| 16.3                     | Signal louvres and visors   |  |
| 16.4                     | Background screens (optionally with white retro-reflective borders)                     |  |
| 16.5                     | Yellow retro-reflective strips for signal posts (optional)                              |  |

| VEHICLE DETECTION |  |  |
|-------------------|--|--|
| 7                 | Vehicle-actuated control type and methodology  |  |
| 7.8/20.5          | Number, type and location of vehicle detectors |  |
| 20.4              | Detector operations (latching or non-latching) |  |

| CONTROLLER AND ELECTRICAL |  |  |
|---------------------------|--|--|
| 18.7                      | Location of controller (according to requirements) |  |
| 22                        | Source of power                                    |  |
| 22.4                      | Cable ducts and draw boxes                         |  |
| 22.2                      | Wiring, Number of cores                            |  |
| 5.6                       | Road lighting considered                           |  |

| REMARKS |
|---------|
|         |

|   |              |   |              |  |
|---|--------------|---|--------------|--|
| <br>Consulting<br>Engineer | DESIGNED BY  | <br>Responsible<br>Authority | APPROVED BY  | N/S Street<br>&<br>E/W Street<br>Intersection No<br>NNNN |
|   | Signed       |   | Signed       |  |
|   | Name         |   | Name         |  |
|   | Position     |   | Position     |  |
|   | Registration |   | Registration |  |
| Date  | Date         |   |              |  |

## C.2 TRAFFIC SIGNAL PHASING AND TIMING CHECKLIST

| SECTION | REQUIREMENT | CHECKED |
|---------|-------------|---------|
|---------|-------------|---------|



| GENERAL  |   |  |
|----------|---|--|
| 1.2/6.16 | Signal configuration diagrams provided                  |  |
| 30       | Version number  |  |
| 1.2      | Diagrams signed by responsible engineer or technologist |  |

| TRAFFIC LIGHT SIGNALS |  |  |
|-----------------------|--|--|
| 3.5.1                 | Basic sequence of light signals (green, yellow, red)                                     |  |
| 3.5.1                 | Differently coloured signals not displayed together to the same movement                 |  |
| 3.5.3/6.8             | Yellow signal not to right-turn movement at same time as opposing traffic receives green |  |
| 3.5.1                 | Yellow arrow may be omitted under specific circumstances                                 |  |
| 3.5.1                 | Yellow signals not in flashing mode  |  |
| 3.5.4                 | Steady green right arrow not used when there is an opposing movement                     |  |
| 3.5.4                 | Steady green arrow and green disc light signals not displayed on the same approach       |  |
| 3.5.4                 | Flashing green arrows not used when there is an opposing movement                        |  |
| 3.5.4                 | Pedestrian signals recommended when flashing green arrows used                           |  |
| 3.5                   | Green light signal not used in both steady and flashing modes                            |  |
| 3.6                   | No flashing signals in place of normal traffic signal operations                         |  |
| 3.6                   | Start-up procedure for traffic signals   |  |

| PEDESTRIAN AND PEDAL CYCLISTS |   |  |
|-------------------------------|---|--|
| 4.3.2                         | Pedestrian green – 4 to 7 seconds   |  |
| 4.3.3                         | Pedestrian walking speed of 1,2 or 1,0 m/s                                      |  |
| 4.3.3                         | Flashing red man reduced and replaced by steady red man (max 75% or intergreen) |  |
| 4.3.3                         | Flashing red man terminate before parallel all-red period                       |  |
| 4.3.3                         | Pedestrian green phase not in conflict with flashing vehicular green            |  |

| TRAFFIC SIGNAL TIMING AND PHASING |  |  |
|-----------------------------------|--|--|
| 6.6                               | Recent traffic counts, Counts to standards   |  |
| 6.5                               | Signal timing plans  |  |
| 6.9                               | Left-turn phases (check pedestrians)   |  |
| 6.10/6.11                         | Right-turn phases where required   |  |
| 5.3.7                             | Protected-only right-turn phase when signalised slipway provided                       |  |
| 6.10.3                            | Leading/lagging right-turn phase appropriate, single lagging right-turn phase checked  |  |
| 3.5.4                             | Green light signals minimum safety requirements  |  |
| 3.5/6.12                          | Yellow and all-red intervals   |  |
| 6.12.4/6.8                        | Longer all-red intervals on slipways (and when main phase followed by left-turn phase) |  |
| 6.13.4                            | Critical movement analysis used in signal timings                                      |  |
| 6.14                              | Signal co-ordination acceptable (queues and platoon dispersion taken into account)     |  |
| 6.14.6                            | Progression speed acceptable, possibility of speeding checked                          |  |
| 6.14.8                            | Possibility of obstructive (damaging) queue lengths checked                            |  |

| REMARKS |
|---------|
|         |

|   |              |   |              |                               |
|---|--------------|---|--------------|-------------------------------|
| <br>Consulting<br>Engineer | INSPECTED BY | <br>Responsible<br>Authority | APPROVED BY  | N/S Street<br>&<br>E/W Street |
|   | Signed       |   | Signed       |                               |
|   | Name         |   | Name         |                               |
|   | Position     |   | Position     | Intersection No               |
|   | Registration |   | Registration |                               |
| Date  | Date         | NNNN  |              |                               |



**C.3 TRAFFIC SIGNAL COMMISSIONING CHECKLIST**

| SECTION | REQUIREMENT | CHECKED |
|---------|-------------|---------|
|---------|-------------|---------|

| GENERAL |   |  |
|---------|---|--|
| 1.2     | As-built layout plans and timing diagrams, Modifications shown and approved     |  |
| 1.2     | Layout plans and timing diagrams signed by responsible engineer or technologist |  |

| GEOMETRIC DESIGN, ROAD SIGNS AND CIVIL ENGINEERING |   |  |
|--|---|--|
| 5  | Layout and geometric design of junction or crossing         |  |
| 5  | Road works as per civil engineering requirements            |  |
| 5  | Road signs and markings                                     |  |
| 5  | Parking space for signal maintenance vehicles               |  |
| 5  | Final clean up and finishing off, removal of waste material |  |

| TRAFFIC SIGNAL HEADS AND FACES |  |  |
|--------------------------------|--|--|
| 3.5.1                          | Signal heads masked out during installation, and other junction control in place     |  |
| 3                              | Types of traffic signal faces, signal symbols (disc, arrow, etc.)                    |  |
| 16.4                           | Background screens (backboards) provided, white retro-reflective border if specified |  |
| 16.2.3                         | Signal aspect sizes, lenses, reflectors  |  |
| 16.3                           | Signal visors (and louvres)  |  |
| 16.2.2                         | Luminous intensity (normal or high)  |  |
| 3.11                           | Alignment of signal axis   |  |
| 3.11                           | Signal faces intended for specific movements not be mistaken by other movements      |  |
| 3.7                            | All vehicular light signals on same horizontal level                                 |  |
|                                | Installation, damage, cleanliness, etc.  |  |

| POSITION OF SIGNAL HEADS AND FACES |  |  |
|------------------------------------|--|--|
| 3                                  | Locations and directions of traffic signal faces                                       |  |
| 3.9.1                              | Far-side signal faces not nearer than 6 m from stop line (10 m preferable)             |  |
| 3.9.1                              | Far-side signal faces not less than 3 m apart, nor further than 20 m (16 m preferable) |  |
| 3.9.2                              | Near-side signal faces not further than 3 m from stop line                             |  |
| 3.12.1                             | Minimum clearance distance - 0,5 or 0,1 m on medians where crossfall falls away        |  |
| 3.12.2                             | Maximum lateral distance - not further than 2 m from left edge of roadway              |  |
| 3.12.2                             | Post minimum/maximum mounting heights - 2,3 m/3,0 m – 2,1 m pedestrian minimum         |  |
| 3.12.2                             | Totem mounting heights - 1 m separation  |  |
| 3.12.2                             | Overhead minimum/maximum clearance/mounting heights - 5,2 m/6,2 m                      |  |
| 3.12.5                             | Overhead preferably on left-hand side of road  |  |

| PEDESTRIAN SIGNAL FACES AND PUSH BUTTONS |   |  |
|--|---|--|
| 4.6                                      | Locations and directions of pedestrian signal heads                               |  |
| 4.7                                      | Red man signal not higher than vehicular green signal (may be on the same height) |  |
| 4.7                                      | Location and directions of push buttons, 1,1 m heights                            |  |
| 4.7                                      | Pedestrian symbols on push buttons  |  |
|  | Correct operation by testing each button  |  |
|  | Installation, damage  |  |

| SIGNAL POSTS |   |  |
|--------------|---|--|
| 16.5         | Foundations, anchor bolts, size and depth, backfill, concrete strength (where used) |  |
|              | Conduit entry, capping before pouring of concrete                                   |  |
|              | Vertical alignment of posts, cantilevers and gantries                               |  |
| 16.5         | Yellow retro-reflectorised strips provided if specified                             |  |
|              | Paint work, damage  |  |



| VEHICLE DETECTORS (CHECKED DURING INSTALLATION) |   |  |
|---|---|--|
| 20.5.2  | Location, dimensions and layout   |  |
| 20.5.3  | Saw cut width and depth. Debris, dirt and moisture removed                          |  |
| 20.5.3  | Correct loop wiring, no splicing, no damage, no sharp corners, correct depth        |  |
| 20.5.3  | Proper sealing of slot, proper adherence to pavement                                |  |
| 20.5  | Correct operation by using actual vehicle or a metal sheet that simulates a vehicle |  |

| TRAFFIC SIGNAL CONTROLLER |   |  |
|---------------------------|---|--|
| 18.7                      | Location of controller  |  |
|                           | Foundation and fixing, alignment  |  |
| 18                        | Controller type   |  |
|                           | Cables entering cabinet (adequately sealed)   |  |
| 18.7                      | Sealing and waterproofing, operation of cabinet doors                               |  |
|                           | Cleanliness, damage, paint work   |  |
| 6                         | Operation, signal plans, phases and timing, co-ordination, fallback plan            |  |
|                           | Manual control panel operation  |  |
| 19.5                      | Communication with central control system, synchronisation                          |  |
| 18.4                      | Conflict monitoring   |  |
| 18                        | Signal start-up sequence, Restart after power failure (retention of signal timings) |  |
| 18.5                      | Fault monitoring, red lamp monitoring   |  |
| 30                        | Maintenance record in cabinet   |  |

| DUCTS, DRAW BOXES AND TRENCHES (CHECKED DURING CONSTRUCTION) |   |  |
|--|---|--|
| 22   | Location and sizes, materials, damage and cleanliness               |  |
| 22   | Provision of draw wire in all ducts                                 |  |
| 22   | Excavation trench width and depth, preparation of trenches and beds |  |
| 22   | Compaction of excavations, backfill material, Asphalt reinstatement |  |
| 26   | Sidewalks, paving, plants and grass                                 |  |
| 26   | Damaged services  |  |

| ELECTRICAL (ALL ELECTRICAL WORK TO BE APPROVED BY A QUALIFIED ELECTRICIAN) |   |  |
|--|---|--|
| 22   | Power supply (source of power)                                |  |
| 22   | Earthing, ground rods   |  |
|  | Conduits - size and type, collapsed sections, bending, joints |  |
|  | Cables and wiring, colour coding and tags, damage.            |  |
| 22   | Provision of drip loops                                       |  |
| 22   | No unauthorised splicing of cables                            |  |
|  | Wiring tested for continuity and electrical leaks             |  |
| 22   | Wiring certificate issued                                     |  |

| REMARKS |
|---------|
|         |

|   |              |   |              |  |
|---|--------------|---|--------------|--|
| <br>Consulting<br>Engineer | INSPECTED BY | <br>Responsible<br>Authority | APPROVED BY  | N/S Street<br>&<br>E/W Street<br><br>Intersection No<br>NNNN |
|   | Signed       |   | Signed       |  |
|   | Name         |   | Name         |  |
|   | Position     |   | Position     |  |
|   | Registration |   | Registration |  |
| Date  | Date         |   |              |  |

# **SOUTH AFRICAN ROAD TRAFFIC SIGNS MANUAL**

## **VOLUME 3: TRAFFIC SIGNAL DESIGN**

***DIGITISED VERSION – May 2012***









### **APPENDIX D**

#### **TRAFFIC SIGNAL FORMS**



# Layout Plan

Signal face types shown together with signal groups (between parentheses)

|               |   |  |   |                 |
|---------------|---|--|---|-----------------|
| <b>Legend</b> |  Vehicular signal faces<br> Extended (Totem)<br> Existing signal faces |  Pedestrian signal faces<br> Push Button<br> Detector unit No |  Controller<br> Overhead mounting | Scale           |
|               | DESIGNED BY   |  | APPROVED BY   |                 |
|               | Signed  |  | Signed  |                 |
|               | Name  |  | Name  |                 |
|               | Position  |  | Position  |                 |
|               | Registration  |  | Registration  | Intersection No |
|               | Date  |  | Date  |                 |

# Layout Plan

(Signal groups given between parentheses)

## Legend

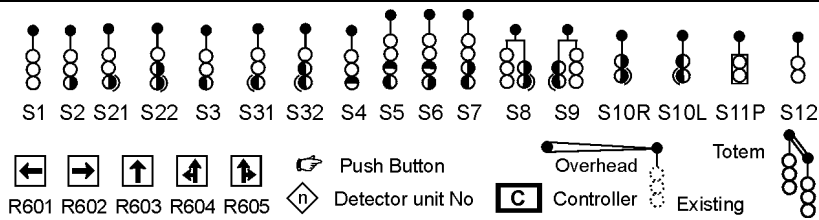

Scale

|  |  |  |                 |
|--|--|--|-----------------|
|  | DESIGNED BY<br><br><div style="text-align: right;">Signed</div> Name<br>Position<br>Registration<br>Date | APPROVED BY<br><br><div style="text-align: right;">Signed</div> Name<br>Position<br>Registration<br>Date |                 |
|  |  |  | Intersection No |

# Signal groups and staging

## Signal groups [SANS phases]

|  |                    |
|--|--------------------|
|  | Flashing green     |
|  | Steady green       |
|  | Permitted movement |

## Signal staging (showing signal groups)

|         |         |         |         |
|---------|---------|---------|---------|
| Stage 1 | Stage 2 | Stage 3 | Stage 4 |
|         |         |         |         |
| Stage 5 | Stage 6 | Stage 7 | Stage 8 |
|         |         |         |         |

Notes – Stage 1 should be selected as the first permanently available stage, preferably on the main road.

Stages given and numbered in the sequence they will be displayed.

|      |              |              |              |  |
|------|--------------|--------------|--------------|--|
|      | DESIGNED BY  |              | APPROVED BY  |  |
|      | Signed       |              | Signed       |  |
|      | Name         |              | Name         |  |
|      | Position     |              | Position     |  |
|      | Registration |              | Registration |  |
| Date | Date         | Junction No: |              |  |

## Signal group and stage data

### Signal group [SANS phase] data (defining safety minimum green, yellow and all-red intervals)

| Signal group   | Phase type | Green delay | Min green/<br>Ped green | Yellow/<br>Flash man | Min all-red | P<br>N | Signal group conflict monitoring |   |   |   |   |   |   |   |   |   |  |  |  |  |  |
|--|------------|-------------|-------------------------|----------------------|-------------|--------|----------------------------------|---|---|---|---|---|---|---|---|---|--|--|--|--|--|
|  |            |             |                         |                      |             |        | A                                | B | C | D | E | F | G | I | J | K |  |  |  |  |  |
|  |            |             |                         |                      |             |        |                                  |   |   |   |   |   |   |   |   |   |  |  |  |  |  |
|  |            |             |                         |                      |             |        |                                  |   |   |   |   |   |   |   |   |   |  |  |  |  |  |
|  |            |             |                         |                      |             |        |                                  |   |   |   |   |   |   |   |   |   |  |  |  |  |  |
|  |            |             |                         |                      |             |        |                                  |   |   |   |   |   |   |   |   |   |  |  |  |  |  |
|  |            |             |                         |                      |             |        |                                  |   |   |   |   |   |   |   |   |   |  |  |  |  |  |
|  |            |             |                         |                      |             |        |                                  |   |   |   |   |   |   |   |   |   |  |  |  |  |  |
|  |            |             |                         |                      |             |        |                                  |   |   |   |   |   |   |   |   |   |  |  |  |  |  |
|  |            |             |                         |                      |             |        |                                  |   |   |   |   |   |   |   |   |   |  |  |  |  |  |
|  |            |             |                         |                      |             |        |                                  |   |   |   |   |   |   |   |   |   |  |  |  |  |  |
| Phase types: Main, Left-turn, Right-turn, Pedestrian, Cyclist<br>Green delay used to provide additional all-red interval (e.g. on slipways)<br>P/N: Green starts or ends with Previous or Next intergreen period |            |             |                         |                      |             |        | X In conflict                    |   |   |   |   |   |   |   |   |   |  |  |  |  |  |

### Interstage times and stage to stage movements

| From Stage | To stage |   |   |   |   |   |   |   |
|------------|----------|---|---|---|---|---|---|---|
|            | 1        | 2 | 3 | 4 | 5 | 6 | 7 | 8 |
| 1          |          |   |   |   |   |   |   |   |
| 2          |          |   |   |   |   |   |   |   |
| 3          |          |   |   |   |   |   |   |   |
| 4          |          |   |   |   |   |   |   |   |
| 5          |          |   |   |   |   |   |   |   |
| 6          |          |   |   |   |   |   |   |   |
| 7          |          |   |   |   |   |   |   |   |
| 8          |          |   |   |   |   |   |   |   |

### Detector data

| Detector Unit No | Signal group | Extension time (sec) | Latch call (Y/N) | Call delay (s) |
|------------------|--------------|----------------------|------------------|----------------|
|                  |              |                      |                  |                |
|                  |              |                      |                  |                |
|                  |              |                      |                  |                |
|                  |              |                      |                  |                |
|                  |              |                      |                  |                |
|                  |              |                      |                  |                |
|                  |              |                      |                  |                |
|                  |              |                      |                  |                |
|                  |              |                      |                  |                |
|                  |              |                      |                  |                |
|                  |              |                      |                  |                |
|                  |              |                      |                  |                |
|                  |              |                      |                  |                |
|                  |              |                      |                  |                |
|                  |              |                      |                  |                |
|                  |              |                      |                  |                |
|                  |              |                      |                  |                |
|                  |              |                      |                  |                |
|                  |              |                      |                  |                |
|                  |              |                      |                  |                |

| Stage selection (programming) |                                      |             | When no demand revert to stage |
|-------------------------------|--------------------------------------|-------------|--------------------------------|
| Stage                         | Select stage when demand detected by | Extended by |                                |
| 1                             |                                      |             |                                |
| 2                             |                                      |             |                                |
| 3                             |                                      |             |                                |
| 4                             |                                      |             |                                |
| 5                             |                                      |             |                                |
| 6                             |                                      |             |                                |
| 7                             |                                      |             |                                |
| 8                             |                                      |             |                                |

OR = Stage selected when demand detected at ANY of the detector units  
 AND = Stage selected when demand detected at ALL of the detector units  
 NOT = Stage selected when NO demand detected at ALL of the detector units

Pedestrian push button call delay indicates the time buttons must be pressed to register demand

|      |              |  |              |              |  |
|------|--------------|--|--------------|--------------|--|
|      | DESIGNED BY  |  | APPROVED BY  |              |  |
|      | SIGNED       |  | SIGNED       |              |  |
|      | Name         |  | Name         |              |  |
|      | Position     |  | Position     |              |  |
|      | Registration |  | Registration |              |  |
| Date |              |  | Date         | Junction No: |  |



## Signal plans and timings

### Event table

| Day of week | Start time | End time | Plan No | Offset Stage 1 |
|-------------|------------|----------|---------|----------------|
|             |            |          |         |                |
|             |            |          |         |                |
|             |            |          |         |                |
|             |            |          |         |                |
|             |            |          |         |                |
|             |            |          |         |                |
|             |            |          |         |                |
|             |            |          |         |                |

### Fallback Plan No

| Day of week | Start time | End time | Plan No | Offset Stage 1 |
|-------------|------------|----------|---------|----------------|
|             |            |          |         |                |
|             |            |          |         |                |
|             |            |          |         |                |
|             |            |          |         |                |
|             |            |          |         |                |
|             |            |          |         |                |
|             |            |          |         |                |
|             |            |          |         |                |

### Signal plans and timings

| Plan No | Mode |           | Stage 1 | Stage 2 | Stage 3 | Stage 4 | Stage 5 | Stage 6 | Stage 7 | Stage 8 | Cycle length |
|---------|------|-----------|---------|---------|---------|---------|---------|---------|---------|---------|--------------|
| 1       |      | Min green |         |         |         |         |         |         |         |         |              |
|         |      | Max green |         |         |         |         |         |         |         |         |              |
|         |      | Perm/Skip |         |         |         |         |         |         |         |         |              |
| 2       |      | Min green |         |         |         |         |         |         |         |         |              |
|         |      | Max green |         |         |         |         |         |         |         |         |              |
|         |      | Perm/Skip |         |         |         |         |         |         |         |         |              |
| 3       |      | Min green |         |         |         |         |         |         |         |         |              |
|         |      | Max green |         |         |         |         |         |         |         |         |              |
|         |      | Perm/Skip |         |         |         |         |         |         |         |         |              |
| 4       |      | Min green |         |         |         |         |         |         |         |         |              |
|         |      | Max green |         |         |         |         |         |         |         |         |              |
|         |      | Perm/Skip |         |         |         |         |         |         |         |         |              |
| 5       |      | Min green |         |         |         |         |         |         |         |         |              |
|         |      | Max green |         |         |         |         |         |         |         |         |              |
|         |      | Perm/Skip |         |         |         |         |         |         |         |         |              |
| 6       |      | Min green |         |         |         |         |         |         |         |         |              |
|         |      | Max green |         |         |         |         |         |         |         |         |              |
|         |      | Perm/Skip |         |         |         |         |         |         |         |         |              |
| 7       |      | Min green |         |         |         |         |         |         |         |         |              |
|         |      | Max green |         |         |         |         |         |         |         |         |              |
|         |      | Perm/Skip |         |         |         |         |         |         |         |         |              |
| 8       |      | Min green |         |         |         |         |         |         |         |         |              |
|         |      | Max green |         |         |         |         |         |         |         |         |              |
|         |      | Perm/Skip |         |         |         |         |         |         |         |         |              |
| 9       |      | Min green |         |         |         |         |         |         |         |         |              |
|         |      | Max green |         |         |         |         |         |         |         |         |              |
|         |      | Perm/Skip |         |         |         |         |         |         |         |         |              |
| 10      |      | Min green |         |         |         |         |         |         |         |         |              |
|         |      | Max green |         |         |         |         |         |         |         |         |              |
|         |      | Perm/Skip |         |         |         |         |         |         |         |         |              |

Modes: Fixed time, Linked fixed time, Fully-VA, Semi-VA, Linked semi-VA.

P = Permanent, S= Skip stage  
(Linked semi-VA: Extend stage number)

|      |              |              |              |  |
|------|--------------|--------------|--------------|--|
|      | DESIGNED BY  |              | APPROVED BY  |  |
|      | Signed       |              | Signed       |  |
|      | Name         |              | Name         |  |
|      | Position     |              | Position     |  |
|      | Registration |              | Registration |  |
| Date | Date         | Junction No: |              |  |

## TRAFFIC SIGNAL LAYOUT CHECKLIST (1/3)

| SECTION                 | REQUIREMENT  | CHECKED |
|-------------------------|--|---------|
| <b>GENERAL</b>          |  |         |
| 1.2                     | Location of installation, north arrow  |         |
| 1.2                     | Drawing to scale, Scale shown  |         |
| 30                      | Version number   |         |
| 1.2                     | Signature of responsible registered professional engineer or technologist            |         |
| <b>SIGNAL WARRANTS</b>  |  |         |
| 2.2                     | Minimum requirements for installation of traffic signals met                         |         |
| 2.3                     | Alternatives that may obviate the need for traffic signals not viable or feasible    |         |
| 2.4.2                   | Queue length warrants met  |         |
| <b>SPEED LIMITS</b>     |  |         |
| 3.10                    | Speed limits given. No limit exceeds 80 km/h   |         |
| 3.10                    | Measures on high-speed roads considered (traffic circles, etc.)                      |         |
| <b>BASE PLAN</b>        |  |         |
| 26.4                    | Property boundaries and fences   |         |
| 26.4                    | Roads, islands, medians and paint markings   |         |
| 26.4                    | Approach gradients   |         |
| 26.4                    | Paved sidewalks, driveways   |         |
| 26.4                    | Drainage structures  |         |
| 26.4                    | Plants and vegetation  |         |
| 26.4                    | Engineering services   |         |
| 26.4                    | Roadside furniture   |         |
| 26.4                    | Structures and buildings   |         |
| <b>GEOMETRIC DESIGN</b> |  |         |
| 5.2.3                   | Spacing of signalised junctions acceptable   |         |
| 5.2.4                   | Intersection angle minimum 70 degrees, including slipways                            |         |
| 5.2.5                   | Sight distance requirements met (stopping, traffic signal faces, right-turn)         |         |
| 5.3.4                   | Right-turn sight distance adequate (particularly on wide medians/curves)             |         |
| 5.2.6                   | Design vehicle swept paths   |         |
| 5.2.7                   | Lane widths (approach and exit sides)  |         |
| 5.2.8                   | Median widths (minimum 1,2 m, but 2 m minimum when pedestrians)                      |         |
| 5.2.9                   | Junction corner radius (8 to 10m radii preferred), Barrier kerbs                     |         |
| 5.3.1                   | Auxiliary through lane (100 m beyond junction)                                       |         |
| 5.3.2                   | Left-turn lane provided when there is an opportunity for separate phase              |         |
| 5.3.3                   | Right-turn lane where possible, should be provided when speed exceeds 60 km/h        |         |
| 5.3.6                   | Auxiliary lane designs and lengths   |         |
| 5.3.5                   | Double and triple turn requirements (triple only at T-junctions and one-way streets) |         |
| 5.3.7                   | Slipway design requirements met, 70 degrees maximum                                  |         |
| 3.3                     | Slipways separated from main junction by means of a constructed island               |         |
| 26.4                    | Parking space for signal maintenance vehicles  |         |

## TRAFFIC SIGNAL LAYOUT CHECKLIST (2/3)

### ROAD SIGNS AND MARKINGS

|         |   |  |
|---------|---|--|
| 3.4     | Control precedence of signs (pedestrian, bus or tram, arrows, disc light signals)       |  |
| 3.4/5.4 | Road signs that may and may not be used with traffic signals                            |  |
| 5.4     | Pedestrian prohibited sign R218 provided where required                                 |  |
| 5.4     | Traffic signal ahead warning signs provided where required (new signals, 70 km/h, etc.) |  |
| 5.5.1   | Stop lines  |  |
| 5.5.2   | Pedestrian crossing lines (should be provided, except where sign R218 used)             |  |
| 5.5.3   | Lane direction arrows   |  |
| 5.5.3   | Regulatory road markings  |  |
| 5.5.4   | Warning road markings   |  |
| 5.5.5   | Guidance road markings  |  |
| 5.3.4   | When signal face S1R used, right-turn lanes separated by painted island or similar      |  |

### TRAFFIC SIGNAL FACES

|     |  |  |
|-----|--|--|
| 3.8 | Only prescribed traffic signal faces used  |  |
| 3.7 | No duplicate light signals on one face   |  |
| 3.8 | Signal arrow signs ST1 to ST5 only used when faces S1L and S1R used                  |  |
| 3.8 | Signal face S1 not used on same approach as S2, S3, S4, S5, S6 and S7                |  |
| 3.8 | Signal faces S1R and S1L without ST3 and ST2 on slipways, otherwise with ST3 and ST2 |  |
| 3.8 | Signal faces S2, S3, S4, S5, S6 and S7 only when specific turns not allowed          |  |
| 3.8 | Signal faces S2, S6 and S7 not when there is an opposing conflicting movement        |  |
| 3.8 | Signal faces S10R and S10L preferably not in a stand-alone location                  |  |

### PRINCIPAL SIGNAL FACES

|       |  |  |
|-------|--|--|
| 1.2.4 | Number, type and location of traffic signal faces  |  |
| 3.9.1 | Two signal faces containing a red signal on the far side of stop line                      |  |
| 3.9.1 | Additional far-side signal faces when further apart than 20 m (preferable 16 m)            |  |
| 3.9.1 | One signal face with red signal on near side (recommended at pedestrian crossings)         |  |
| 3.9.1 | Two faces with flashing green signals for turning phases (one far side, other far or near) |  |
| 3.9.1 | Far-side signal faces not nearer than 6 m from stop line (10 m preferable)                 |  |
| 3.9.1 | Far-side signal faces not less than 3 m apart, nor further than 20 m (16 m preferable)     |  |
| 3.9.2 | Near-side signal faces not further than 3 m from stop line                                 |  |

### SUPPLEMENTARY SIGNAL FACES

|        |   |  |
|--------|---|--|
| 1.2.4  | Number, type and location of traffic signal faces                                   |  |
| 3.11   | At least two signal faces visible over minimum sight distances                      |  |
| 3.11   | At least two signal faces on far side visible over minimum distance of 50 m         |  |
| 3.11   | At least one signal face visible in cone of vision                                  |  |
| 3.11   | At least one signal face visible for right-turning vehicles waiting within junction |  |
| 3.11   | Additional faces provided for consistency and uniformity                            |  |
| 3.12.3 | Overhead signals on high-speed roads or to ensure consistency/uniformity            |  |

### MOUNTING OF TRAFFIC SIGNAL FACES

|        |  |  |
|--------|--|--|
| 3.11   | No distracting advertisements and features near signal faces                   |  |
| 3.12.1 | Minimum clearance distance (0,5 or 0,1 m on medians when crossfalls fall away) |  |
| 3.12.2 | Maximum lateral distance (not further than 2 m from left edge of roadway)      |  |
| 3.12.5 | Overhead signals on left-hand side of road                                     |  |

## TRAFFIC SIGNAL LAYOUT CHECKLIST (3/3)

### PEDESTRIAN AND PEDAL CYCLIST SIGNALS

|     |   |  |
|-----|---|--|
| 1.2 | Number, type and location of pedestrian signal faces          |  |
| 4.6 | Location of pedestrian signal faces                           |  |
| 4.3 | Push buttons provided and pedestrian signals demand dependent |  |
| 4.7 | Push button locations and directions                          |  |
| 4.6 | Staggered crossing considered                                 |  |

### SIGNAL ASPECTS AND POSTS

|        |   |  |
|--------|---|--|
| 16.2.2 | Luminous intensity (normal or high – high on roads with speed limit 70 km/h or greater) |  |
| 16.2.3 | Aspect sizes (210 or 300 mm)  |  |
| 16.3   | Signal louvres and visors   |  |
| 16.4   | Background screens (optionally with white retro-reflective borders)                     |  |
| 16.5   | Yellow retro-reflective strips for signal posts (optional)                              |  |

### VEHICLE DETECTION

|          |  |  |
|----------|--|--|
| 7        | Vehicle-actuated control type and methodology  |  |
| 7.8/20.5 | Number, type and location of vehicle detectors |  |
| 20.4     | Detector operations (latching or non-latching) |  |

### CONTROLLER AND ELECTRICAL

|      |  |  |
|------|--|--|
| 18.7 | Location of controller (according to requirements) |  |
| 22   | Source of power                                    |  |
| 22.4 | Cable ducts and draw boxes                         |  |
| 22.2 | Wiring, Number of cores                            |  |
| 5.6  | Road lighting considered                           |  |

### REMARKS

|      |                    |  |                    |                 |
|------|--------------------|--|--------------------|-----------------|
|      | <b>DESIGNED BY</b> |  | <b>APPROVED BY</b> |                 |
|      | Signed             |  | Signed             |                 |
|      | Name               |  | Name               |                 |
|      | Position           |  | Position           |                 |
|      | Registration       |  | Registration       | Intersection No |
| Date | Date               |  |                    |                 |

## TRAFFIC SIGNAL PHASING AND TIMING CHECKLIST

| SECTION | REQUIREMENT | CHECKED |
|---------|-------------|---------|
|---------|-------------|---------|

| GENERAL  |   |  |
|----------|---|--|
| 1.2/6.16 | Signal configuration diagrams provided                  |  |
| 30       | Version number  |  |
| 1.2      | Diagrams signed by responsible engineer or technologist |  |

| TRAFFIC LIGHT SIGNALS |  |  |
|-----------------------|--|--|
| 3.5.1                 | Basic sequence of light signals (green, yellow, red)                                     |  |
| 3.5.1                 | Differently coloured signals not displayed together to the same movement                 |  |
| 3.5.3/6.8             | Yellow signal not to right-turn movement at same time as opposing traffic receives green |  |
| 3.5.1                 | Yellow arrow may be omitted under specific circumstances                                 |  |
| 3.5.1                 | Yellow signals not in flashing mode  |  |
| 3.5.4                 | Steady green right arrow not used when there is an opposing movement                     |  |
| 3.5.4                 | Steady green arrow and green disc light signals not displayed on the same approach       |  |
| 3.5.4                 | Flashing green arrows not used when there is an opposing movement                        |  |
| 3.5.4                 | Pedestrian signals recommended when flashing green arrows used                           |  |
| 3.5                   | Green light signal not used in both steady and flashing modes                            |  |
| 3.6                   | No flashing signals in place of normal traffic signal operations                         |  |
| 3.6                   | Start-up procedure for traffic signals   |  |

| PEDESTRIAN AND PEDAL CYCLISTS |   |  |
|-------------------------------|---|--|
| 4.3.2                         | Pedestrian green – 4 to 7 seconds   |  |
| 4.3.3                         | Pedestrian walking speed of 1,2 or 1,0 m/s                                      |  |
| 4.3.3                         | Flashing red man reduced and replaced by steady red man (max 75% or intergreen) |  |
| 4.3.3                         | Flashing red man terminate before parallel all-red period                       |  |
| 4.3.3                         | Pedestrian green phase not in conflict with flashing vehicular green            |  |

| TRAFFIC SIGNAL TIMING AND PHASING |  |  |
|-----------------------------------|--|--|
| 6.6                               | Recent traffic counts, Counts to standards   |  |
| 6.5                               | Signal timing plans  |  |
| 6.9                               | Left-turn phases (check pedestrians)   |  |
| 6.10/6.11                         | Right-turn phases where required   |  |
| 5.3.7                             | Protected-only right-turn phase when signalised slipway provided                       |  |
| 6.10.3                            | Leading/lagging right-turn phase appropriate, single lagging right-turn phase checked  |  |
| 3.5.4                             | Green light signals minimum safety requirements  |  |
| 3.5/6.12                          | Yellow and all-red intervals   |  |
| 6.12.4/6.8                        | Longer all-red intervals on slipways (and when main phase followed by left-turn phase) |  |
| 6.13.4                            | Critical movement analysis used in signal timings                                      |  |
| 6.14                              | Signal co-ordination acceptable (queues and platoon dispersion taken into account)     |  |
| 6.14.6                            | Progression speed acceptable, possibility of speeding checked                          |  |
| 6.14.8                            | Possibility of obstructive (damaging) queue lengths checked                            |  |

|                |
|----------------|
| <b>REMARKS</b> |
|----------------|

|  |   |  |  |  |                 |
|--|---|--|--|--|-----------------|
|  | INSPECTED BY<br><br><div style="text-align: right; margin-right: 20px;">Signed</div> Name<br>Position<br>Registration<br>Date |  | APPROVED BY<br><br><div style="text-align: right; margin-right: 20px;">Signed</div> Name<br>Position<br>Registration<br>Date |  | Intersection No |
|--|---|--|--|--|-----------------|

## TRAFFIC SIGNAL COMMISSIONING CHECKLIST (1/2)

| SECTION | REQUIREMENT | CHECKED |
|---------|-------------|---------|
|---------|-------------|---------|

### GENERAL

|     |   |  |
|-----|---|--|
| 1.2 | As-built layout plans and timing diagrams, Modifications shown and approved     |  |
| 1.2 | Layout plans and timing diagrams signed by responsible engineer or technologist |  |

### GEOMETRIC DESIGN, ROAD SIGNS AND CIVIL ENGINEERING

|   |   |  |
|---|---|--|
| 5 | Layout and geometric design of junction or crossing         |  |
| 5 | Road works as per civil engineering requirements            |  |
| 5 | Road signs and markings                                     |  |
| 5 | Parking space for signal maintenance vehicles               |  |
| 5 | Final clean up and finishing off, removal of waste material |  |

### TRAFFIC SIGNAL HEADS AND FACES

|        |  |  |
|--------|--|--|
| 3.5.1  | Signal heads masked out during installation, and other junction control in place     |  |
| 3      | Types of traffic signal faces, signal symbols (disc, arrow, etc.)                    |  |
| 16.4   | Background screens (backboards) provided, white retro-reflective border if specified |  |
| 16.2.3 | Signal aspect sizes, lenses, reflectors  |  |
| 16.3   | Signal visors (and louvres)  |  |
| 16.2.2 | Luminous intensity (normal or high)  |  |
| 3.11   | Alignment of signal axis   |  |
| 3.11   | Signal faces intended for specific movements not be mistaken by other movements      |  |
| 3.7    | All vehicular light signals on same horizontal level                                 |  |
|        | Installation, damage, cleanliness, etc.  |  |

### POSITION OF SIGNAL HEADS AND FACES

|        |  |  |
|--------|--|--|
| 3      | Locations and directions of traffic signal faces                                       |  |
| 3.9.1  | Far-side signal faces not nearer than 6 m from stop line (10 m preferable)             |  |
| 3.9.1  | Far-side signal faces not less than 3 m apart, nor further than 20 m (16 m preferable) |  |
| 3.9.2  | Near-side signal faces not further than 3 m from stop line                             |  |
| 3.12.1 | Minimum clearance distance - 0,5 or 0,1 m on medians where crossfall falls away        |  |
| 3.12.2 | Maximum lateral distance - not further than 2 m from left edge of roadway              |  |
| 3.12.2 | Post minimum/maximum mounting heights - 2,3 m/3,0 m – 2,1 m pedestrian minimum         |  |
| 3.12.2 | Totem mounting heights - 1 m separation  |  |
| 3.12.2 | Overhead minimum/maximum clearance/mounting heights - 5,2 m/6,2 m                      |  |
| 3.12.5 | Overhead preferably on left-hand side of road  |  |

### PEDESTRIAN SIGNAL FACES AND PUSH BUTTONS

|     |   |  |
|-----|---|--|
| 4.6 | Locations and directions of pedestrian signal heads                               |  |
| 4.7 | Red man signal not higher than vehicular green signal (may be on the same height) |  |
| 4.7 | Location and directions of push buttons, 1,1 m heights                            |  |
| 4.7 | Pedestrian symbols on push buttons  |  |
|     | Correct operation by testing each button  |  |
|     | Installation, damage  |  |

### SIGNAL POSTS

|      |   |  |
|------|---|--|
| 16.5 | Foundations, anchor bolts, size and depth, backfill, concrete strength (where used) |  |
|      | Conduit entry, capping before pouring of concrete                                   |  |
|      | Vertical alignment of posts, cantilevers and gantries                               |  |
| 16.5 | Yellow retro-reflectorised strips provided if specified                             |  |
|      | Paint work, damage  |  |

## TRAFFIC SIGNAL COMMISSIONING CHECKLIST (1/2)

### VEHICLE DETECTORS (CHECKED DURING INSTALLATION)

|        |   |  |
|--------|---|--|
| 20.5.2 | Location, dimensions and layout   |  |
| 20.5.3 | Saw cut width and depth. Debris, dirt and moisture removed                          |  |
| 20.5.3 | Correct loop wiring, no splicing, no damage, no sharp corners, correct depth        |  |
| 20.5.3 | Proper sealing of slot, proper adherence to pavement                                |  |
| 20.5   | Correct operation by using actual vehicle or a metal sheet that simulates a vehicle |  |

### TRAFFIC SIGNAL CONTROLLER

|      |   |  |
|------|---|--|
| 18.7 | Location of controller  |  |
|      | Foundation and fixing, alignment  |  |
| 18   | Controller type   |  |
|      | Cables entering cabinet (adequately sealed)   |  |
| 18.7 | Sealing and waterproofing, operation of cabinet doors                               |  |
|      | Cleanliness, damage, paint work   |  |
| 6    | Operation, signal plans, phases and timing, co-ordination, fallback plan            |  |
|      | Manual control panel operation  |  |
| 19.5 | Communication with central control system, synchronisation                          |  |
| 18.4 | Conflict monitoring   |  |
| 18   | Signal start-up sequence, Restart after power failure (retention of signal timings) |  |
| 18.5 | Fault monitoring, red lamp monitoring   |  |
| 30   | Maintenance record in cabinet   |  |

### DUCTS, DRAW BOXES AND TRENCHES (CHECKED DURING CONSTRUCTION)

|    |   |  |
|----|---|--|
| 22 | Location and sizes, materials, damage and cleanliness               |  |
| 22 | Provision of draw wire in all ducts                                 |  |
| 22 | Excavation trench width and depth, preparation of trenches and beds |  |
| 22 | Compaction of excavations, backfill material, Asphalt reinstatement |  |
| 26 | Sidewalks, paving, plants and grass                                 |  |
| 26 | Damaged services  |  |

### ELECTRICAL (ALL ELECTRICAL WORK TO BE APPROVED BY A QUALIFIED ELECTRICIAN)

|    |   |  |
|----|---|--|
| 22 | Power supply (source of power)                                |  |
| 22 | Earthing, ground rods   |  |
|    | Conduits - size and type, collapsed sections, bending, joints |  |
|    | Cables and wiring, colour coding and tags, damage.            |  |
| 22 | Provision of drip loops                                       |  |
| 22 | No unauthorised splicing of cables                            |  |
|    | Wiring tested for continuity and electrical leaks             |  |
| 22 | Wiring certificate issued                                     |  |

### REMARKS

|  |              |  |              |                 |
|--|--------------|--|--------------|-----------------|
|  | INSPECTED BY |  | APPROVED BY  |                 |
|  | Signed       |  | Signed       |                 |
|  | Name         |  | Name         |                 |
|  | Position     |  | Position     |                 |
|  | Registration |  | Registration | Intersection No |
|  | Date         |  | Date         |                 |

